

NC Load Frequency Control & Reserve:

Overview last Developments



Table of Contents

- 1. Frequency Quality**
- 2. Load-Frequency Control Structure**
- 3. Frequency Containment Reserves**
- 4. Frequency Restoration Reserves**
- 5. Cross-Border Exchange and Sharing of Reserves**
- 6. Co-operation with DSO**
- 7. Synchronous Time Control**

Frequency Quality Target Parameters

For each synchronous area

	Baltic	Continental Europe	Great Britain	Ireland	Nordic	Cyprus	Iceland
Nominal frequency	50 Hz	50 Hz	50 Hz	50 Hz	50 Hz	50 Hz	50 Hz
Standard frequency range	±50 mHz	±50 mHz	±200 mHz	±200 mHz	±100 mHz	±100 mHz	
Maximum instantaneous frequency deviation	±400 mHz	±800 mHz	±800 mHz	±1000 mHz	±100 mHz	±500 mHz 1.2 Hz from 50 Hz	
Maximum steady-state frequency deviation	±200 mHz (+/-400 mHz but no longer than 72 min. per 24 h)	±200 mHz	±500 mHz	± 500 mHz	±500 mHz	±500 mHz	
Time to restore frequency	20 min	15 min	49.5Hz within 60 seconds	49.5Hz within 1 min	15 min	30 s 49.5 5 min 49.8	

- Target number of minutes outside the Standard Frequency Range
- Numbers do not apply to very small Island Systems (e.g. Sardinia)

For each Control Block

- Standard Frequency Restoration Error Range
- Target number of time intervals outside the Standard Frequency Restoration Error Range (resolution Time to Restore Frequency)

Processes for Frequency Quality Evaluation

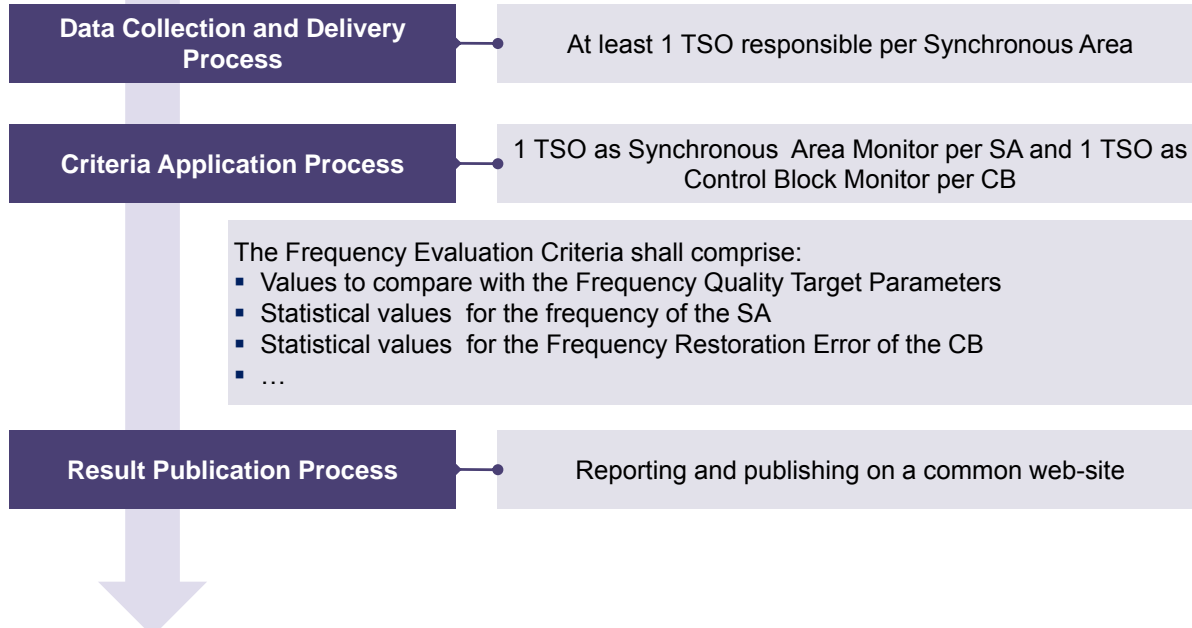

Synchronous Area: Frequency Parameters

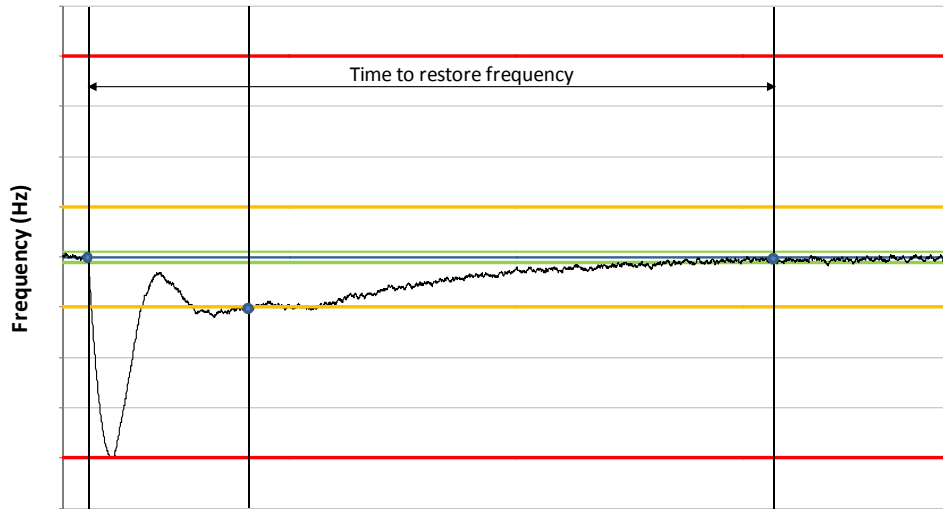

- ✦ “Technical System Parameters” describe the system behaviour and are a matter of fact
- ✦ “Requirements to Market Parties” should be the same within ENTSO-E
- ✦ => as a result the “Frequency Concept” will be variable (as a consequence of different system size, time parameters etc.)

— Nominal frequency
— Frequency
— Maximum absolute frequency deviation
— Standard frequency deviation range
— Maximum quasi-steady-state frequency deviation

Example Frequency Distributions 1/2

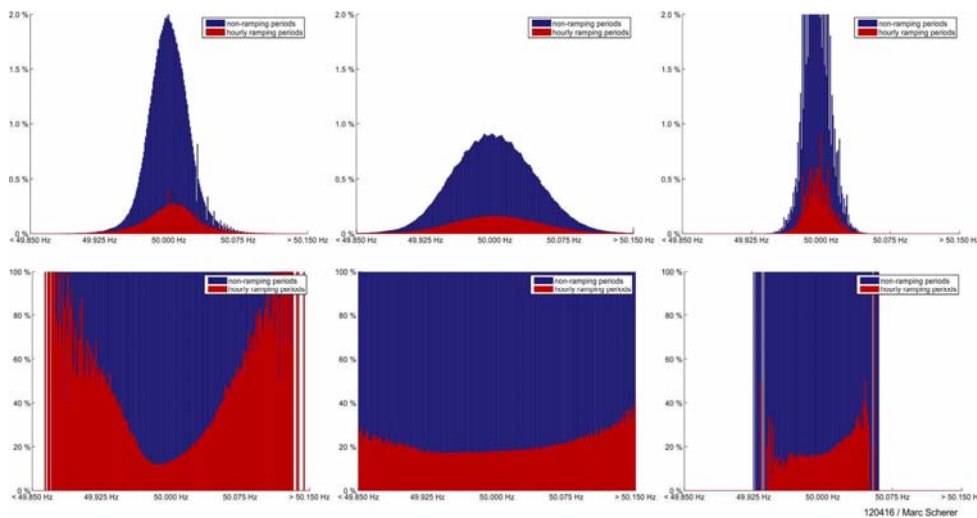

RG CE (2010)

RG Nordic (2010)

RG Baltic (2010)

Example Frequency Distributions 2/2

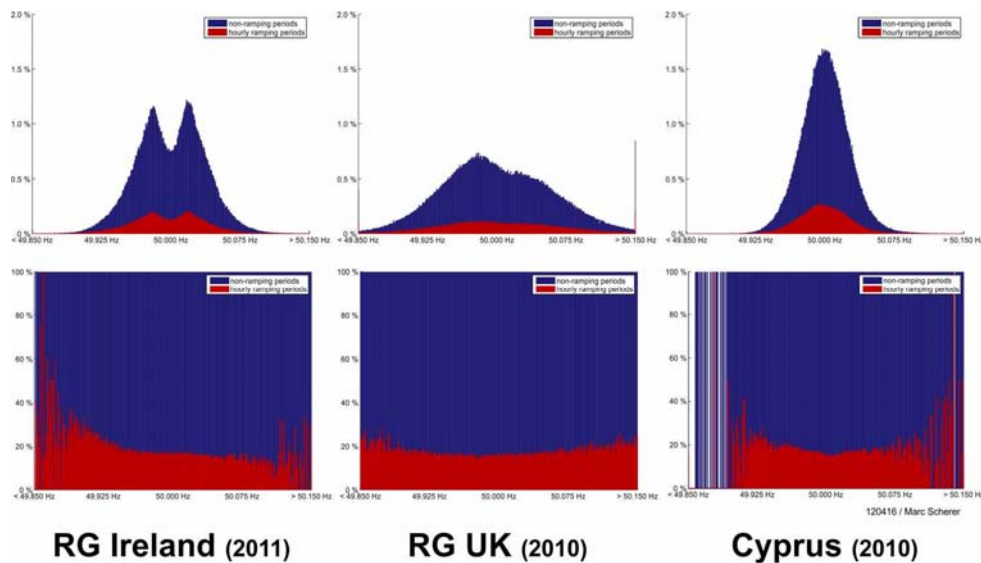
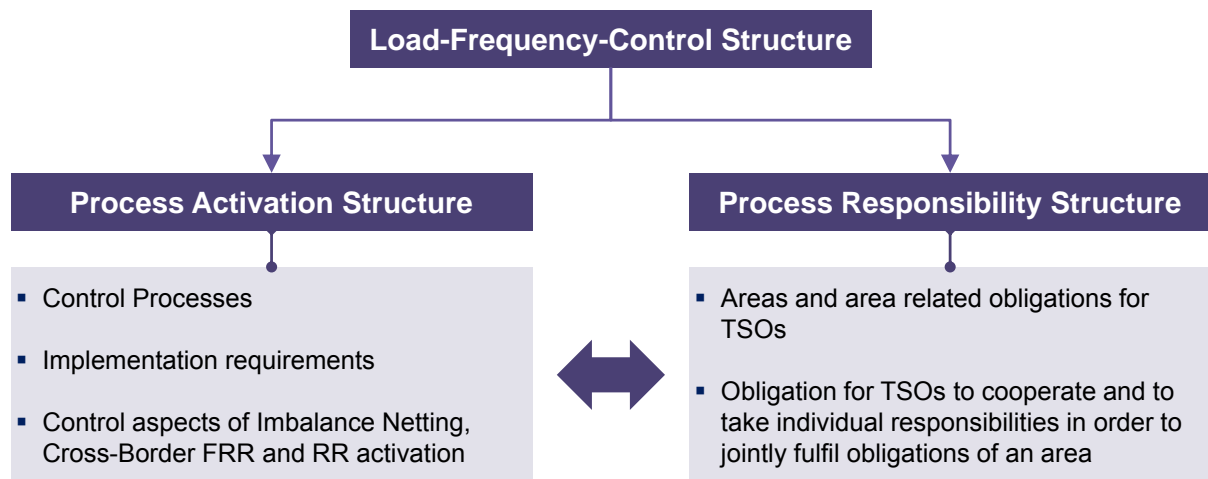

Table of Contents

1. Frequency Quality
2. Load-Frequency Control Structure
3. Frequency Containment Reserves
4. Frequency Restoration Reserves
5. Cross-Border Exchange and Sharing of Reserves
6. Co-operation with DSO
7. Synchronous Time Control

Load-Frequency-Control Structure



Requirements only for **technical** aspects!

Process Responsibility Structure

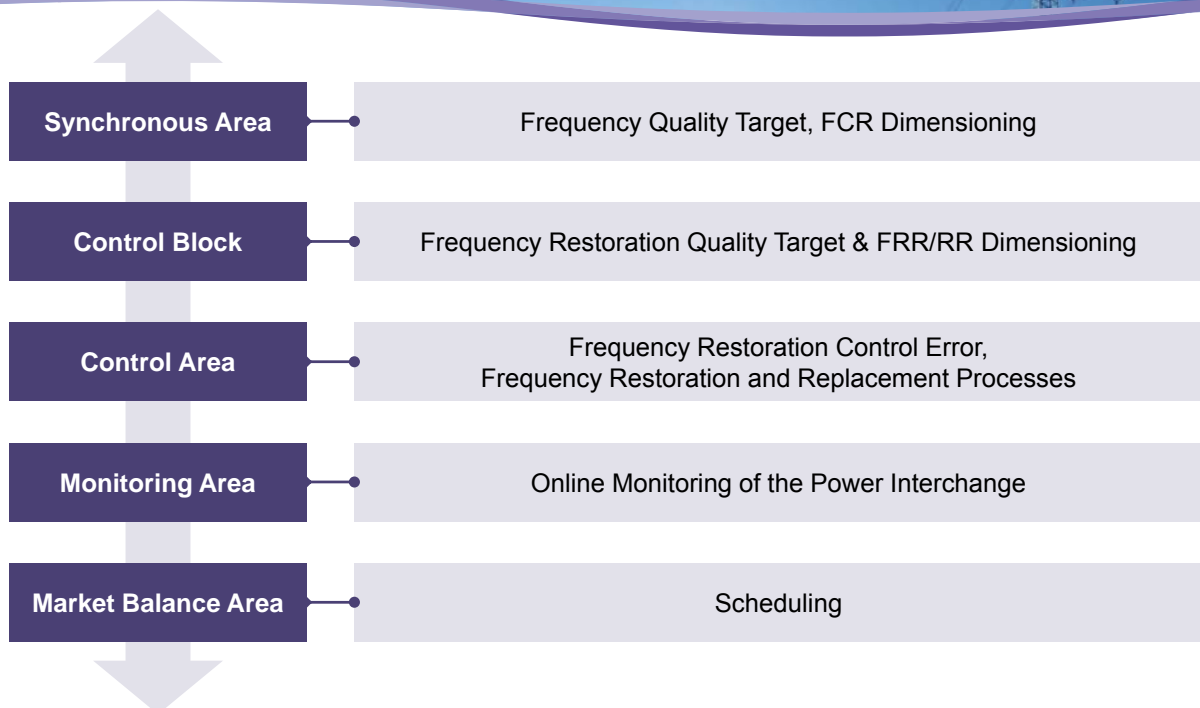

Process Activation Structure

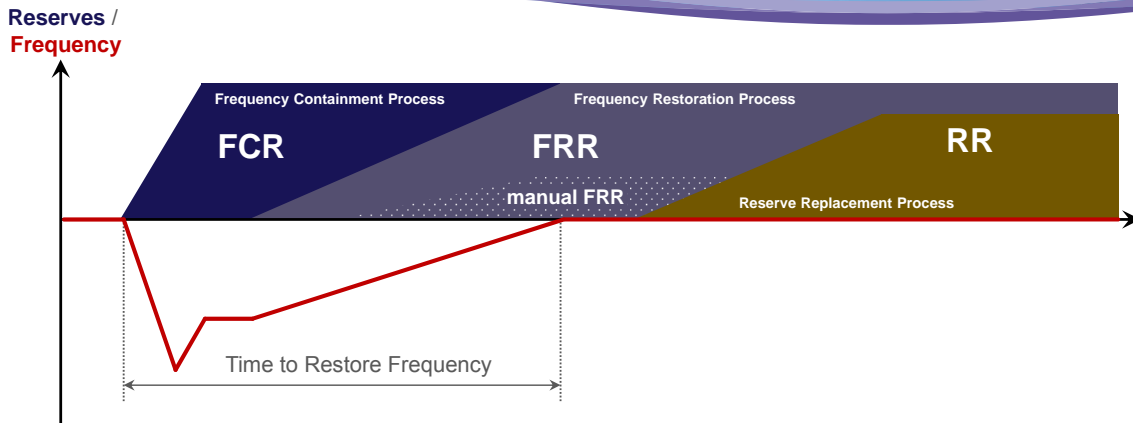

- Frequency Containment Process → Stabilization
- Frequency Restoration Process → Regulate to Set-Point Value
- Reserve Replacement Process → Restore FRR

Structure of Control Blocks in Continental Europe

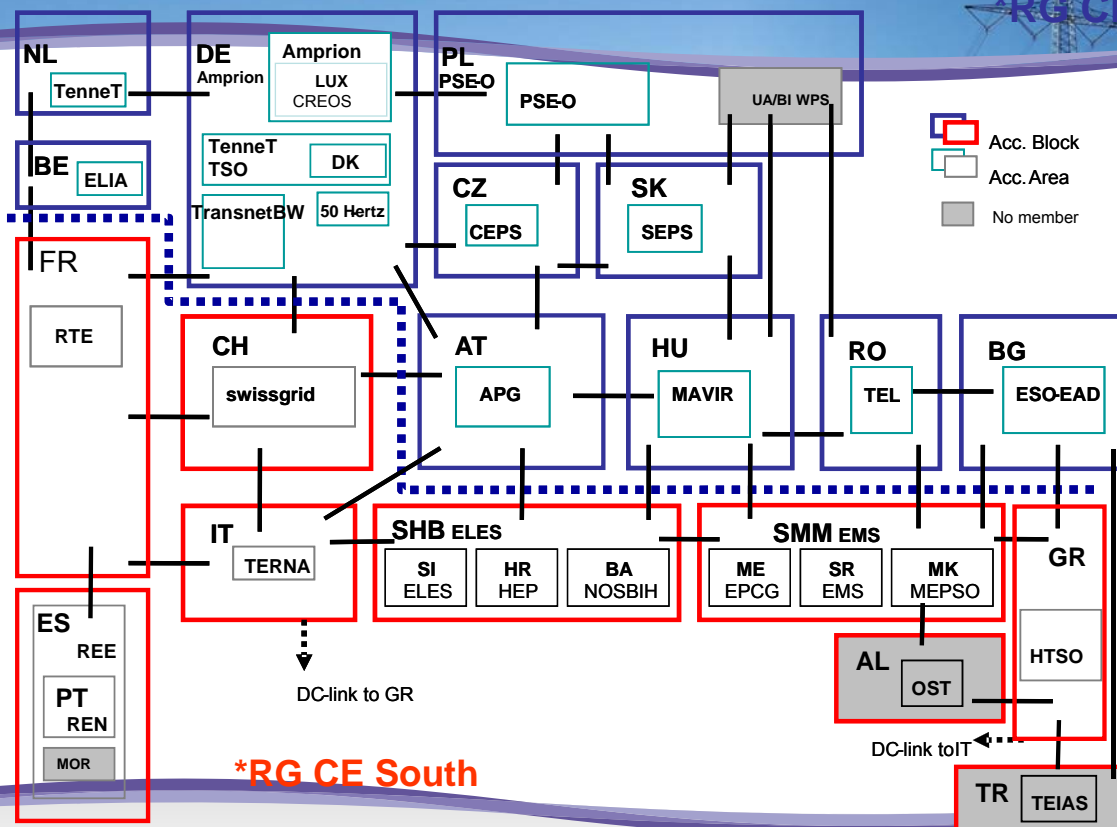

Structure of Control Blocks in Nordic

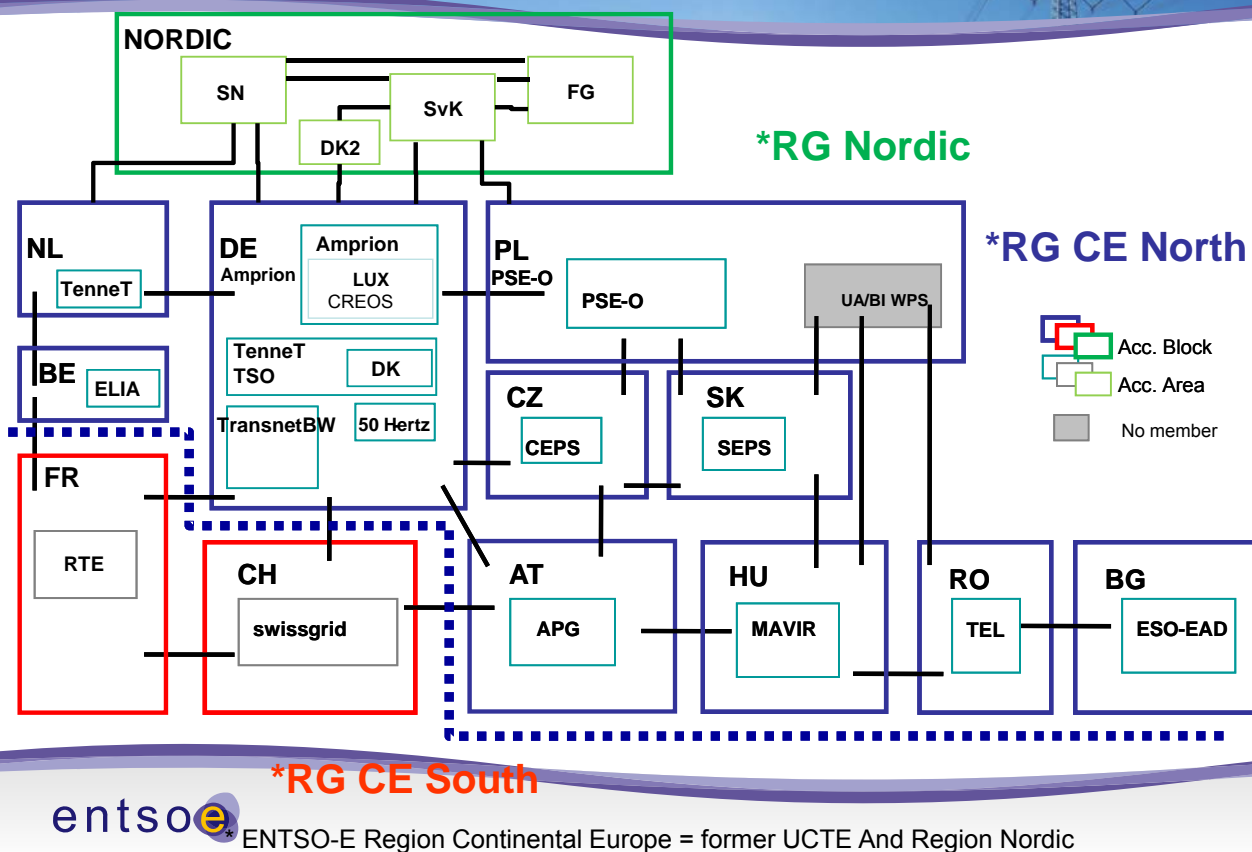

Cross-Border Processes between Control Areas

- Cross-Border Processes:
 - Imbalance Netting*
 - Cross-Border FRR and RR Activation
- Defined for Control Areas
- Power exchange shall not exceed **physically available** transmission capacity (online monitoring)
- Procedures for information and approval by affected TSOs yet to be defined.

Imbalance Netting

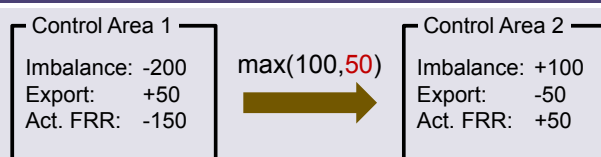

Cross-Border FRR/RR Activation

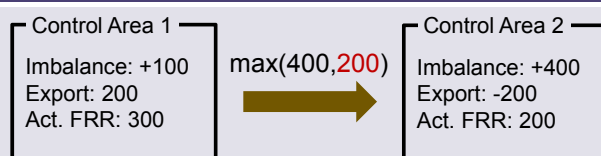

*Imbalance Netting is implicitly performed where there is only one Frequency Restoration Process in the Synchronous Area

Table of Contents

1. Frequency Quality
2. Load-Frequency Control Structure
3. Frequency Containment Reserves
4. Frequency Restoration Reserves
5. Cross-Border Exchange and Sharing of Reserves
6. Co-operation with DSO
7. Synchronous Time Control

Main Aspects

- **Determination of FCR volume (total/shares)**
 - Common approach for dimensioning of total FCR per Synchronous Area based on risk assessment considering behaviour of load and generation and Market Induced Imbalances (covering of probable imbalances; minimum FCR = Reference Incident)
 - Determination of individual shares for TSOs on basis of shares of net generation/consumption
- **Determination of required Properties**
 - Exact requirements for FCR properties that are considered to be stable (minimum accuracy of frequency measurement, minimum insensitivity of the controllers, FCR full activation time, FCR full activation deviation)
 - Joint definition of additional properties per synchronous area (example: FCR activation delay)
- **Reserve Providing Units**
 - FCR Providing Unit may consist of more than one generating/demand facility
 - respective requirements by the Connecting TSO; example: Batteries
 - Definition of maximum concentration of FCR in a FCR Providing Unit and per electrical node

Main Aspects

- **Characteristic of activation (Power to frequency):**
 - linear or piecewise linear
- **Availability**
 - Continuous availability required from FCR Provider; exception: unplanned outages; in that case:
 - information to the TSO
 - replacement asap, but not later than 12 hours after the outage
 - Continuous Activation as long as Frequency Deviation persists
- **Monitoring**
 - Requirement for the TSO; → respective requirement per FCR Providing Unit to make available to the TSO: Status (control on/off), instantaneous active power with/without FCR activation; on request of TSO to be delivered as on line data
- **Inertia**
 - Requirement for collaboration on monitoring and analysis as well as for developing counter measures if required

Table of Contents

1. Frequency Quality
2. Load-Frequency Control Structure
3. Frequency Containment Reserves
4. Frequency Restoration Reserves
5. Cross-Border Exchange and Sharing of Reserves
6. Co-operation with DSO
7. Synchronous Time Control

Frequency Restoration Reserves Dimensioning

On Synchronous Area Level

- Definition of a Frequency Restoration (FR) Quality Target per Control Block
- Obligation for and Commitment of Control Block to fulfill individual Quality Target

Dimensioning on Control Block Level

- Keynote: Reserves need to be sufficient to fulfill FR Quality Target
- Dimensioning based on historical data
- FRR Capacity larger than Dimensioning Incident
- According to Imbalance Properties
 - Automatic Full Activation Time
 - Manual Full Activation Time
- In case of insufficient Reserves -> Escalation Procedures
- Sharing (individual reduction) allowed predominantly for small Control Blocks

Reserve Connecting TSO

- Prequalification Process
- Monitoring Process
- Availability Requirements for Providers

Frequency Restoration Reserves Requirements

On Synchronous Area Level

- One Reserve Connecting TSO per Providing Unit
- For Automatic FRR:
 - Delay Time (first reaction): 30 sec
- Ramp Rate
- Full Activation Time \leq Time to Restore Frequency (RG CE: 15 minutes)

On Control Block Level

- Obligation to respect individual:
 - Automatic Full Activation Time
 - Manual Full Activation Time

Reserve Connecting TSO

- Prequalification Process
- Monitoring Process
- Availability Requirements for Providers
- A Providing Unit may consist of several generating of demand facilities, but additional requirements (e.g. individual data supply, ...) may be set

Table of Contents

1. Frequency Quality
2. Load-Frequency Control Structure
3. Frequency Containment Reserves
4. Frequency Restoration Reserves
5. Cross-Border Exchange and Sharing of Reserves
6. Co-operation with DSO
7. Synchronous Time Control

Exchange and sharing of reserves

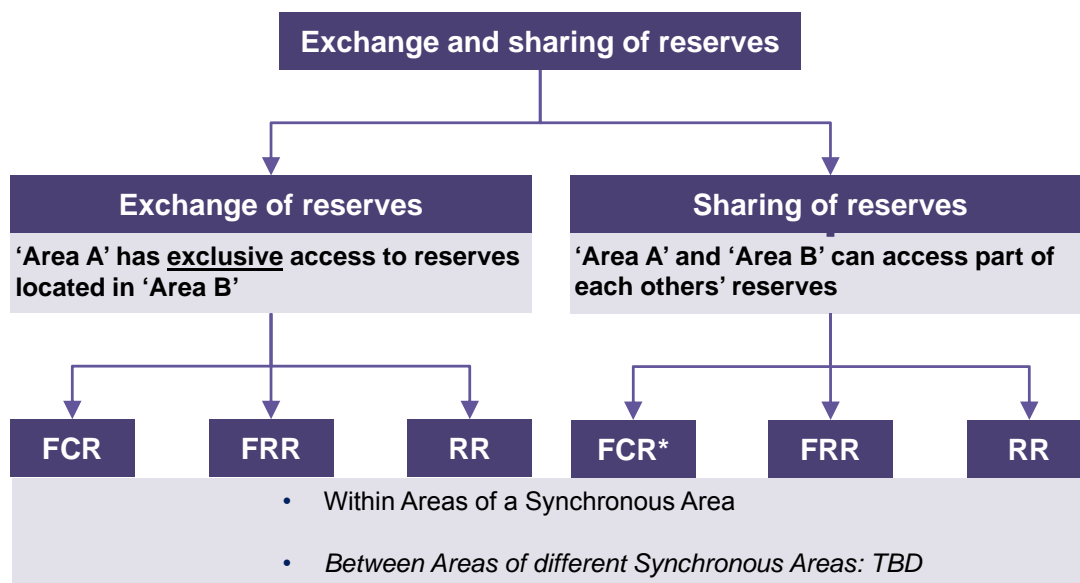

Requirements only for **technical** aspects!

* Shared per definition in Synchronous Area

Exchange of reserves (FCR; FRR; RR)

- Exchange of reserves impacts distribution but not the amount of reserves



- Exclusive access to reserves in another 'Area'
- Limits required to ensure even distribution of reserves for Operational Security
- Limits for exchange apply between 'Areas' defined by each Synchronous Area
 - E.g. RG CE: each **Control Block** can perform up to 30% of its initial FCR, with a minimum of 100 MW, of FCR for other **Control Blocks**
 - E.g. RG CE: each **Control Block** must keep X% of its FRR internally in the **CB**
- Transmission capacity must be available for the exchange of reserves

Sharing of reserves (FRR / RR)

- Sharing of reserves impacts the amount of reserves (and their distribution)

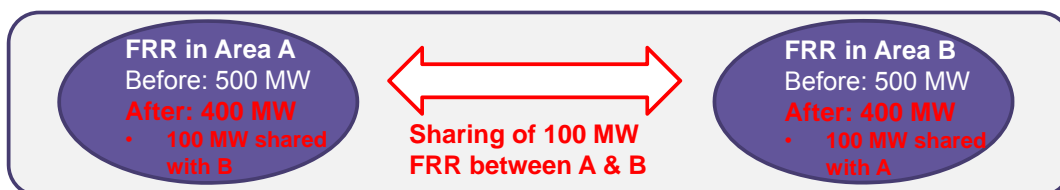

- Non-exclusive access to reserves in another 'Area'
- Sharing predominantly for small Control Blocks with large 'Dimensioning incident'
 - FRR reduction if: 'FRR for Dimensioning incident' > 'FRR for other purposes'
- Limits for sharing apply between 'Areas' defined by each Synchronous Area
- Basic volume of FRR: FRR that an 'Area' cannot share with other 'Areas'
- Maximum FRR reduction: limit for FRR reduction by an 'Area' due to sharing with other 'Areas'
- Transmission capacity must be available for sharing

Table of Contents

1. Frequency Quality
2. Load-Frequency Control Structure
3. Frequency Containment Reserves
4. Frequency Restoration Reserves
5. Cross-Border Exchange and Sharing of Reserves
- 6. Co-operation with DSO**
7. Synchronous Time Control

Reserve Providing Units connected to DSO Grid

Prequalification Phase

- Obligation to Reserve Providers to inform “connecting” DSO about:
 - each Power Generating Module and/or Demand Unit;
 - provided reserve type (FCR, FRR, RR);
 - maximum Reserve Capacity provided by each Power Generation Module and/or Demand Unit; and
 - maximum change of rate of active power for each Power Generation Module and/or Demand Unit
- Right of the DSO to object or set limits to the delivery of Reserves based on security analysis

Operation Phase

- Right of the DSO to request the same level of information as in the prequalification phase if needed for the secure grid operation

Table of Contents

1. Frequency Quality
2. Load-Frequency Control Structure
3. Frequency Containment Reserves
4. Frequency Restoration Reserves
5. Cross-Border Exchange and Sharing of Reserves
6. Co-operation with DSO
- 7. Synchronous Time Control**

Synchronous Time Control

Current State of the NC LFC&R

- The possibility to implement a Synchronous Time Control is currently foreseen in the NC on the basis of a decision of the TSO's of a Synchronous Area

Next Steps

- The Synchronous Time Control is a service from the TSO's to the customers
- During the Public Consultation it will be elaborated if such service is valuable for the customers

Thanks for your Attention!

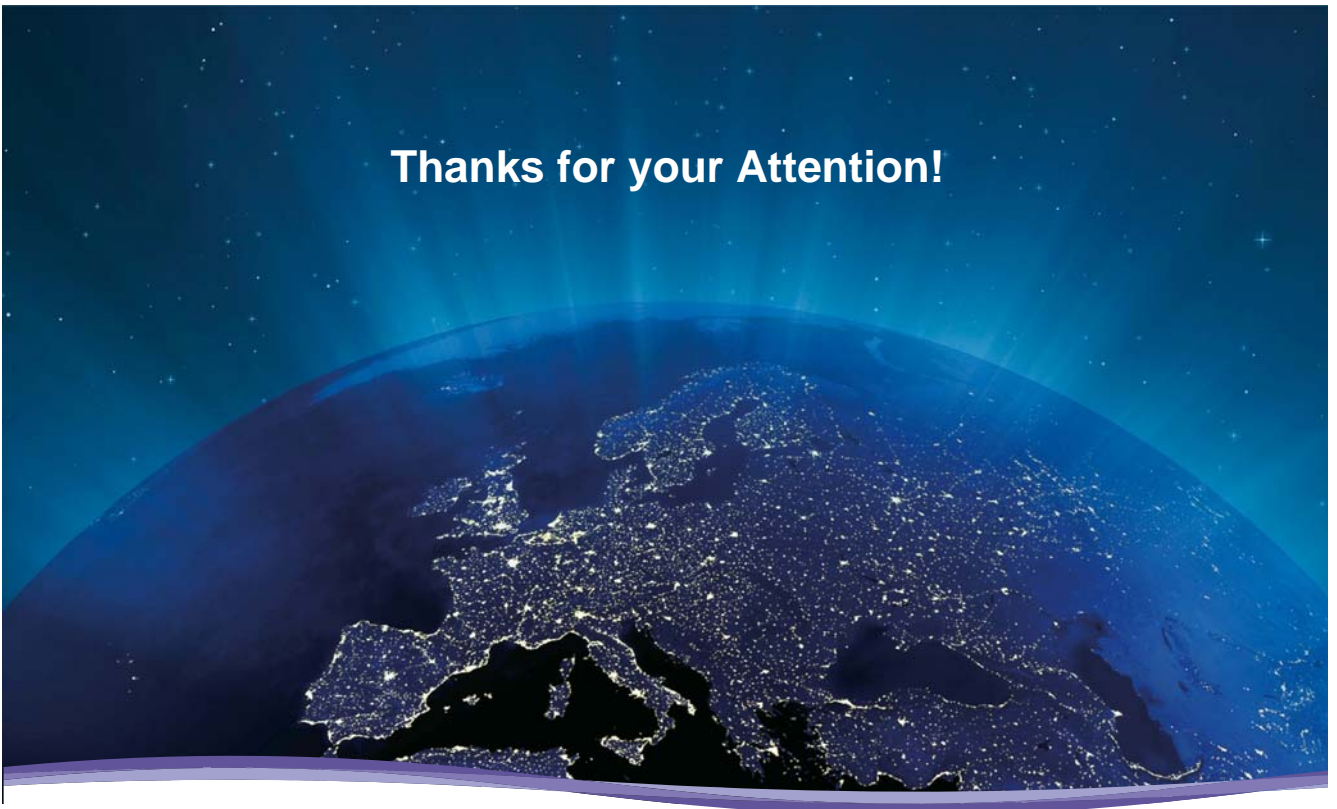

entsoe
Reliable Sustainable Connected