

UCTE



1 / 2004

Half-yearly Report
union for the co-ordination of transmission of electricity

What is the UCTE ?

The Union for the Co-ordination of Transmission of Electricity (UCTE) co-ordinates the interests of transmission system operators in 22 European countries. Their common objective is to maintain the security of operation of the interconnected power system.

50 years of joint activities laid the basis for a leading position in the world which the UCTE holds in terms of the quality of synchronous operation of interconnected power systems. Through the networks of the UCTE, 450 million people are supplied with electric energy; annual electricity consumption totals approx. 2300 TWh.

As of June 2003, the member companies of the UCTE come from the following countries :

| | |
|---|----------------------|
| Belgium (B) | Luxembourg (L) |
| Germany (D) | The Netherlands (NL) |
| Spain (E) | Austria (A) |
| France (F) | Portugal (P) |
| Greece (GR) | Switzerland (CH) |
| Italy (I) | Czech Republic (CZ) |
| Slovenia (SLO) | Hungary (H) |
| Croatia (HR) | Poland (PL) |
| Bosnia-Herzegovina (BiH) | Slovak Republic (SK) |
| Former Yugoslav Republic of Macedonia (FYROM) | Romania* |
| Serbia and Montenegro (SCG) | Bulgaria* |

*Bulgaria and Romania are UCTE members since 8th May 2003, but statistically taken into account since January 2003.

With regard to the other members of ETSO (European Transmission System Operators, 36 Transmission System Operators in 22 countries), the geographical extension of UCTE is represented in the picture below :

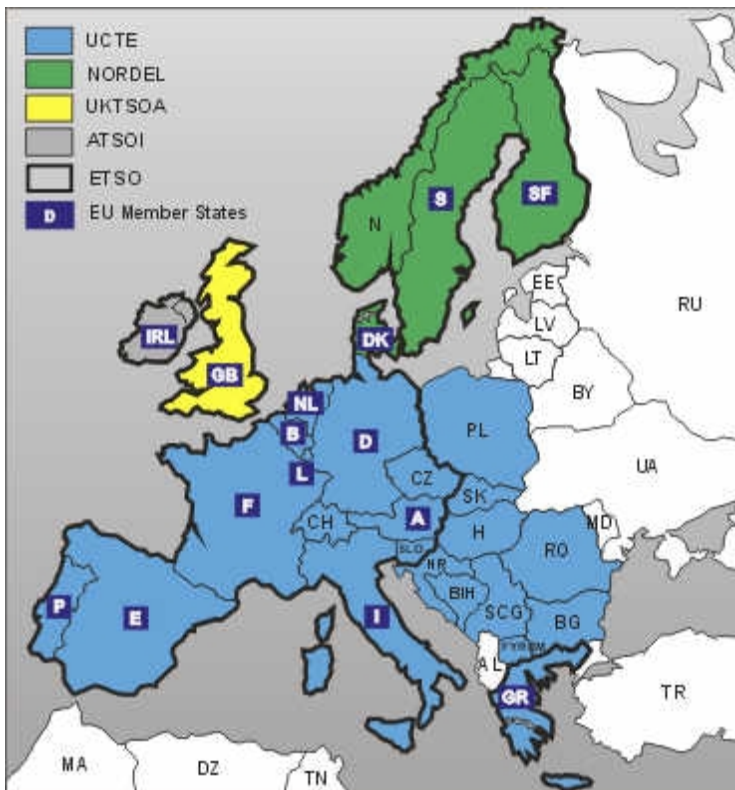

Optimal Co-operation requires joint action

Close co-operation of member companies is imperative to make the best possible use of benefits offered by interconnected operation. For this reason, the UCTE has developed a number of rules and recommendations that constitute the basis for the smooth operation of the power system. Only the consistent maintenance of the high demands on quality will permit to set standards in terms of security and reliability in the future as well as in the past.

The UCTE – Security of electric power supply and promotion of competition

From the very outset of liberalisation in the European electricity markets, the UCTE has intensively pursued the development of schemes for the promotion of competition in the electricity sector. The aim is to support the electricity market without accepting restrictions in the security of supply. The liberalisation of electricity markets cannot be implemented without a transparent and non-discriminatory opening up of electric networks. The UCTE sets the prerequisites that enable a compromise to be ensured between competition and security of supply.

implemented without a transparent and non-discriminatory opening up of electric networks. The UCTE sets the prerequisites that enable a compromise to be ensured between competition and security of supply.

HALF-YEARLY REPORT I - 2004

Table of contents

| Chapter | Page |
|--|------|
| I. Electricity supply situation in UCTE countries in the winter period of 2004 | 5 |
| II. Electricity supply situation in winter | 10 |
| III. Physical energy flows: October 2003 - March 2004 | 11 |
| IV. Regions in parallel operation: January 2004 | 12 |
| V. Load flows: December 2003 and January 2004 | 13 |
| VI. Load diagram: October, November and December 2003 January, February and March 2004..... | 17 |
| VII. UCTE System Adequacy Retrospect 2003 | 24 |

Chapter I -VI are based on values from the UCTE database as of 28 September 2004

Electricity supply situation in UCTE countries in the winter period 2003

1.1 Introduction

This half-yearly report deals with the electricity supply situation, exchanges and load curves during the winter period 2004, i.e. from 1 October 2003 to 31 March, 2004.

The electricity consumption values in this report are net values unadjusted for climatic factors and seasonal variations.

1.2 Electricity supply situation and peak load

The consumption of electricity on the UCTE interconnected system amounted to **1265.9 TWh** during this winter period. The increase of 4.7 % in comparison with the same period in 2003 is mainly due to new UCTE members in RO and BG. The highest consumption increase in the period of report was registered in October with 7.8 %, the lowest was registered in February with 0.3 %.

The peak load from all UCTE countries in the period of report amounted to 359.6 GW at 07:00 p.m. on 17th December, this was 0.3% lower above value of February 2003.

The highest utilisation factor of maximum load was reported in March with 90.4%, while it reached 97.8% in March 2003.

1.3 Generation and hydraulicity

Total generation within UCTE in the period of report amounted to 1289.8 TWh and was made up by 11.8% generation from hydro power, 55.1% non-nuclear thermal generation and 33.1% nuclear generation.

| G1 | Generation within UCTE in the winter period | | | Results in TWh |
|----------------------|---|---------------|--------------------|---------------------|
| | Hydro power | Nuclear power | Conventional power | National production |
| B | 0.8 | 23.3 | 17.5 | 41.5 |
| D | 10.5 | 84.6 | 190.8 | 285.9 |
| E | 22.0 | 30.9 | 66.8 | 119.7 |
| F | 33.6 | 228.9 | 33.8 | 296.3 |
| GR | 2.5 | 0 | 21.9 | 24.4 |
| I | 19.4 | 0 | 123.6 | 143.0 |
| SLO | 1.4 | 2.9 | 2.4 | 6.7 |
| HR | 3.2 | 0 | 3.1 | 6.3 |
| BiH | 3.0 | 0 | 3.8 | 6.8 |
| FYROM | 0.6 | 0 | 2.9 | 3.5 |
| SCG | 6.3 | 0 | 14.9 | 21.2 |
| L | 0.5 | 0 | 1.6 | 2.1 |
| NL | 0 | 1.9 | 46.3 | 48.2 |
| A | 13.3 | 0 | 13.2 | 26.5 |
| P | 8.6 | 0 | 12.6 | 21.2 |
| CH | 13.9 | 14.2 | 1.5 | 29.6 |
| CZ | 1.0 | 13.4 | 27.8 | 42.2 |
| H | 0.1 | 5.5 | 10.5 | 16.1 |
| PL | 1.7 | 0 | 79.5 | 81.2 |
| SK | 1.7 | 8.9 | 5.0 | 15.6 |
| RO | 6.2 | 2.9 | 18.4 | 27.5 |
| BG | 1.6 | 9.4 | 13.0 | 24.0 |
| UCTE | 152.0 | 426.8 | 711.0 | 1289.8 |
| West UA ¹ | 0.1 | 0 | 4.1 | 4.2 |

¹ West UA represents the so-called Burshtyn Island synchronously interconnected with UCTE

G2

Structure of generation within UCTE in the winter period

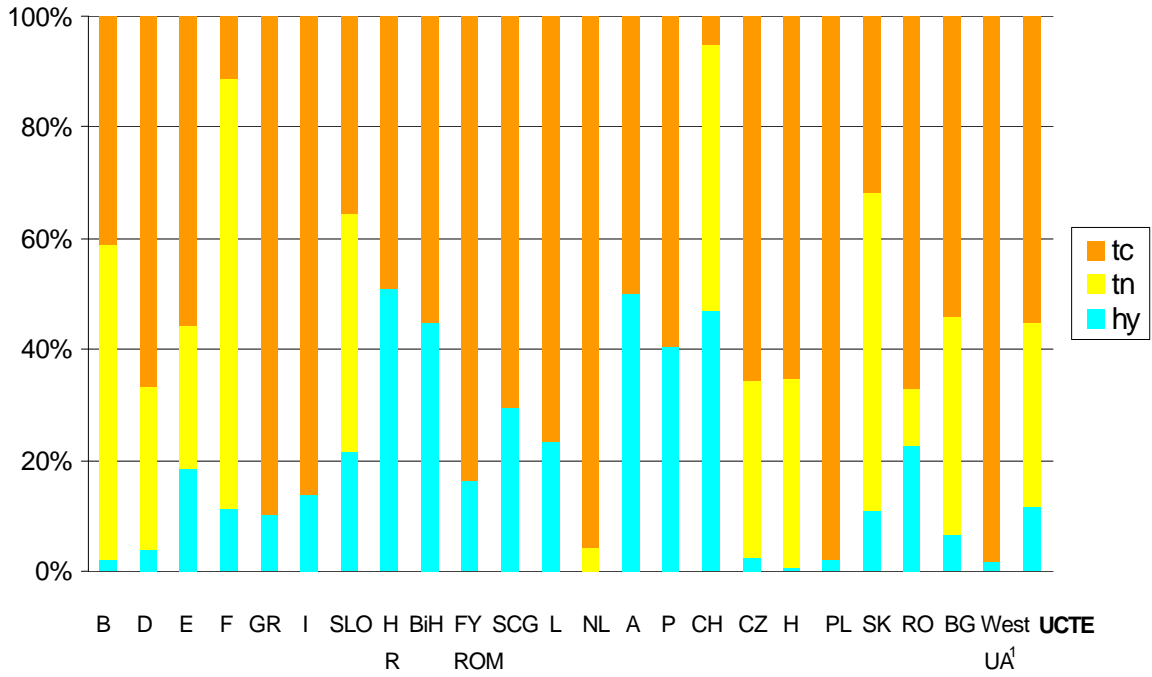

¹ West UA represents the so-called Burshtyn Island synchronously interconnected with UCTE

G3

Percentage of hydropower generation in the aggregate consumption of all countries

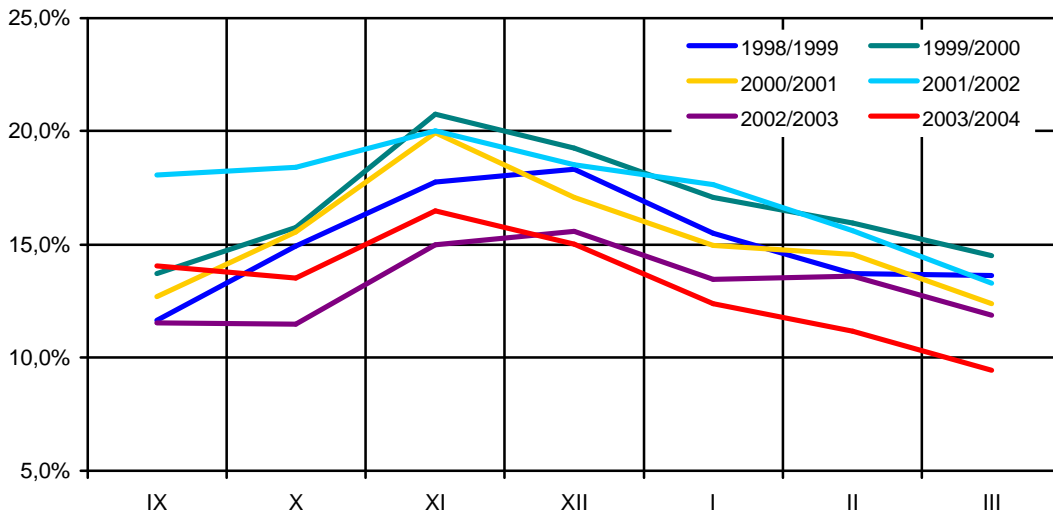

1.4 Electricity exchanges

The total of electricity exchanges, including third countries, was 157323 GWh, corresponding to an increase of 5.2% as compared to the winter period 2003.

France continues to remain the main exporting country with 33.52 TWh where as the highest imports in the period of report were recorded in Italy with 24.84TWh.

| T1 | Balance ¹ of exchanges within UCTE winter period | | Results in GWh |
|------------------|---|---------------|----------------|
| Country | Import | Export | Balance |
| B | 7677 | 3028 | 4649 |
| D | 21175 | 32445 | - 11270 |
| E | 3925 | 4561 | - 636 |
| F | 3203 | 33518 | - 30315 |
| GR | 2188 | 1333 | 855 |
| I | 24839 | 189 | 24650 |
| SLO | 3304 | 3469 | - 165 |
| HR | 4916 | 2657 | 2259 |
| BiH | 887 | 2039 | - 1152 |
| FYROM | 992 | 210 | 782 |
| SCG | 3785 | 1542 | 2243 |
| L | 3391 | 1708 | 1683 |
| NL | 12158 | 2799 | 9359 |
| A | 10794 | 6465 | 4329 |
| P | 3391 | 1337 | 2054 |
| CH | 17523 | 13056 | 4467 |
| CZ | 6295 | 14167 | - 7872 |
| H | 7522 | 3560 | 3962 |
| PL | 2895 | 9609 | - 6714 |
| SK | 5053 | 5830 | - 777 |
| RO | 612 | 1453 | - 841 |
| BG | 265 | 3660 | - 3395 |
| III ² | 10533 | 8688 | |
| UCTE | 146790 | 148635 | - 1845 |

¹ Balance = Import - Export

² Third countries : Albania, Belarus, Denmark (Jutland), Great Britain, Morocco, Republic of Moldavia, Sweden, Burshtyn Island part of Ukraina and Republic of Turkey

T3 Electricity supply situation in winter

| Total consumption¹ | | 10/02-03/03 | 10/03-03/04 | 10/03 | 11/03 | 12/03 | 01/04 | 02/04 | 03/04 |
|---|--|--------------------|--------------------|---------------|---------------|---------------|---------------|---------------|--------------|
| Volume ² Increase | A TWh % | 1209,2 4,7 | 1265,9 4,7 | 200,9 7,8 | 201,9 6,6 | 214,1 6,7 | 226,4 1,4 | 206,8 0,3 | 215,8 6,2 |
| Peak load ³ Increase | B GW % | 360,7 | 359,6 2,6 | 311,9 0,0 | 339,7 4,3 | 359,6 2,6 | 355,8 4,1 | 350,1 3,6 | 320,8 1,5 |
| Utilisation factor of maximum load | C ⁴ = $\frac{A}{h \times B}$ % | 76,8 | 80,1 | 86,6 | 82,6 | 80,0 | 85,5 | 84,9 | 90,4 |
| Total Generation¹ | | | | | | | | | |
| Volume ² Increase | D TWh % | 1237,4 | 1290,2 4,2 | 204,7 7,2 | 206,2 6,0 | 219,1 6,2 | 231,1 1,1 | 210,4 0,2 | 218,6 5,2 |
| Hydroelectric generation ² Increase | D TWh % | 175,5 | 152,0 -13,4 | 21,3 -6,7 | 22,4 -15,5 | 25,8 -16,0 | 27,5 -24,9 | 26,2 -13,3 | 28,8 0,6 |
| Thermal generation ⁵ Increase | T TWh % | 1061,9 | 1138,2 7,2 | 183,4 9,4 | 183,8 9,6 | 193,3 10,4 | 203,6 6,0 | 184,2 2,4 | 189,8 5,8 |
| Non nuclear ² Increase | Tc TWh % | 650,9 | 711,5 9,3 | 116,1 13,4 | 114,1 12,0 | 117,1 12,1 | 126,1 7,3 | 116,0 3,0 | 122,0 8,9 |
| Nuclear ² Increase | Tn GWh % | 411,0 | 426,8 3,8 | 67,3 3,0 | 69,8 6,1 | 76,2 7,8 | 77,5 4,0 | 68,2 1,5 | 67,8 0,5 |

| Electricity exchanges ² | | 10/02-03/03 | 10/03-03/04 | 10/03 | 11/03 | 12/03 | 01/04 | 02/04 | 03/04 |
|-------------------------------------|-------------------|-------------|-------------|-------|-------|-------|-------|-------|-------|
| Volume total | Y | 152,3 | 157,3 | 24,8 | 26,1 | 28,0 | 27,6 | 25,5 | 25,3 |
| Increase | | | 3,3 | 0,9 | 6,5 | 6,5 | 4,3 | 6,9 | -4,8 |
| | TWh | | | | | | | | |
| | % | | | | | | | | |
| Volume of UCTE countries | | 134,8 | 138,1 | 21,9 | 22,9 | 24,6 | 24,2 | 22,4 | 22,2 |
| Increase | | | 2,4 | -0,6 | 5,4 | 6,2 | 2,8 | 6,6 | -5,3 |
| | TWh | | | | | | | | |
| | % | | | | | | | | |
| Share in consumption | $L = \frac{Y}{A}$ | 12,60 | 12,43 | 12,35 | 12,94 | 13,08 | 12,19 | 12,32 | 11,72 |
| Maximum parallel power ³ | M | 370,4 | 361,1 | 320,4 | 338,9 | 356,9 | 361,1 | 352,8 | 327,9 |
| | GW | | | | | | | | |
| Load flow day ⁶ | N | 32266 | 35241 | 30843 | 35241 | 33254 | 34182 | 32890 | 31474 |
| last year | MW | | 32266 | 30126 | 32123 | 32266 | 31521 | 28596 | 31062 |
| Load flow night ⁶ | N | 32173 | 31576 | 28218 | 31576 | 30604 | 29256 | 29916 | 28158 |
| last year | MW | | 32173 | 28006 | 27496 | 31323 | 32119 | 28830 | 32173 |

¹ Percentage as referred to total values (%)

| | B | D | E | F ⁷ | GR ⁸ | I | SLO | HR | BIH | FY | SCG | L | NL | A | P | CH | CZ | H | PL | SK | RO | BG | West | UA |
|-------------|-----|----|----|----------------|-----------------|-----|-----|-----|-----|-----|-----|----|-----|----|----|-----|-----|-----|-----|-----|-----|-----|------|-----|
| Consumption | 99 | 94 | 94 | 97 | 93 | 100 | 95 | 100 | 99 | 100 | 96 | 99 | 100 | 90 | 91 | 100 | 100 | 100 | 100 | 100 | 100 | 100 | 100 | 100 |
| Load | 100 | 91 | 94 | 97 | 93 | 100 | 95 | 100 | 100 | 100 | 96 | 99 | 90 | 82 | 91 | 100 | 100 | 100 | 100 | 100 | 100 | 100 | 100 | 100 |
| Production | 99 | 94 | 94 | 97 | 93 | 100 | 95 | 100 | 99 | 100 | 96 | 98 | 100 | 84 | 91 | 100 | 100 | 100 | 100 | 100 | 100 | 100 | 100 | 100 |

² The UCTE values of 2003 comprise also the areas of the new member companies in Romania and Bulgarian.

³ on the 3rd Wednesday

⁴ h = number of hours in the considered period

⁵ including deliveries from industries of UCTE countries

⁶ sum of exchange balances on all frontiers within the territory of UCTE on the 3rd Wednesday

⁷ consumption in year 2003 = 97%, in year 2004 = 100%; load in year 2003 = 97%, in year 2004 = 100%

⁸ consumption in year 2003 = 93%, in year 2004 = 99%; load in year 2003 = 93%, in year 2004 = 99%



Electricity supply situation in winter

October 2003 - March 2004

| T1 | Electricity supply situation in winter | | October 2003 - March 2004 | | | | |
|----------------------------|--|------------------------|--|--------|------------------|---------------------------|-------------------|
| | National electricity consumption | | Percentage as referred total values ² | | Peak load on the | Date | Time |
| Country | TWh | Δ % ¹ | consumption % | load % | MW | 3 rd Wednesday | |
| B | 45,8 | 1,8 | 99 | 100 | 12890 | 21 January | 07:00 p.m. |
| D | 270,3 | 0,2 | 94 | 91 | 73500 | 17 December | 06:00 p.m. |
| E | 116,6 | 5,0 | 94 | 94 | 36012 | 21 January | 08:00 p.m. |
| F³ | 261,1 | 6,9 | 97 | 100 | 74535 | 21 January | 07:00 p.m. |
| GR⁴ | 24,8 | 2,1 | 93 | 93 | 8084 | 17 December | 06:00 p.m. |
| I | 162,2 | 1,6 | 100 | 100 | 51371 | 17 December | 05:00 p.m. |
| SLO | 6,6 | 4,2 | 95 | 95 | 1920 | 17 December | 06:00 p.m. |
| HR | 8,6 | 5,6 | 100 | 100 | 2602 | 17 December | 06:00 p.m. |
| BIH | 8,1 | n.a. | 99 | 99 | 1681 | 17 December | 06:00 p.m. |
| FYROM | 3,5 | n.a. | 100 | 100 | 1284 | 17 December | 06:00 p.m. |
| SCG | 23,0 | n.a. | 96 | 96 | 6699 | 17 December | 07:00 p.m. |
| L | 3,2 | 2,6 | 99 | 99 | 929 | 18 February | 12:00 a.m. |
| NL | 57,4 | 0,6 | 100 | 90 | 13941 | 17 December | 06:00 p.m. |
| A | 29,3 | 3,7 | 90 | 82 | 8546 | 17 December | 06:00 p.m. |
| P | 23,1 | 3,1 | 92 | 92 | 7673 | 21 January | 08:00 p.m. |
| CH | 32,8 | 3,0 | 100 | 100 | 9342 | 21 January | 10:00 a.m. |
| CZ | 34,0 | 1,3 | 100 | 100 | 9585 | 21 January | 05:00 p.m. |
| H | 20,1 | 0,9 | 100 | 100 | 5887 | 19 November | 05:00 p.m. |
| PL⁵ | 73,3 | - 3,1 | 100 | 100 | 22139 | 17 December | 05:00 p.m. |
| SK | 14,7 | 0,7 | 100 | 100 | 4194 | 17 December | 05:00 p.m. |
| RO | 26,7 | n.a. | 100 | 100 | 7542 | 17 December | 05:00 p.m. |
| BG | 20,5 | n.a. | 100 | 100 | 5999 | 17 December | 07:00 p.m. |
| UCTE | 1265,9 | 4,7⁶ | | | 359627 | 17 December | 07:00 p.m. |
| West UA⁷ | 2,5 | n.a. | 100 | 100 | 939 | 18 February | 07:00 p.m. |

¹ As compared to the last year

² Percentage as referred to the total values of a country.

(The total values of a country are defined as the synchronously interconnected system plus the areas directly connected via AC or DC to the mainland system.)

³ Year 2003 are 97%; year 2004 100%

⁴ Year 2003 are 93%; year 2004 99%

⁵ Gross values

⁶ As compared to the values without RO and BG

⁷ West UA represents the so-called Burshtyn Island synchronously interconnected with UCTE

The fact that the maximum peak load occurred in different months in the individual countries is due to the different climatic and economic conditions as well as to particular national and contractual measures.



Physical energy flows

October 2003 - March 2004

G1

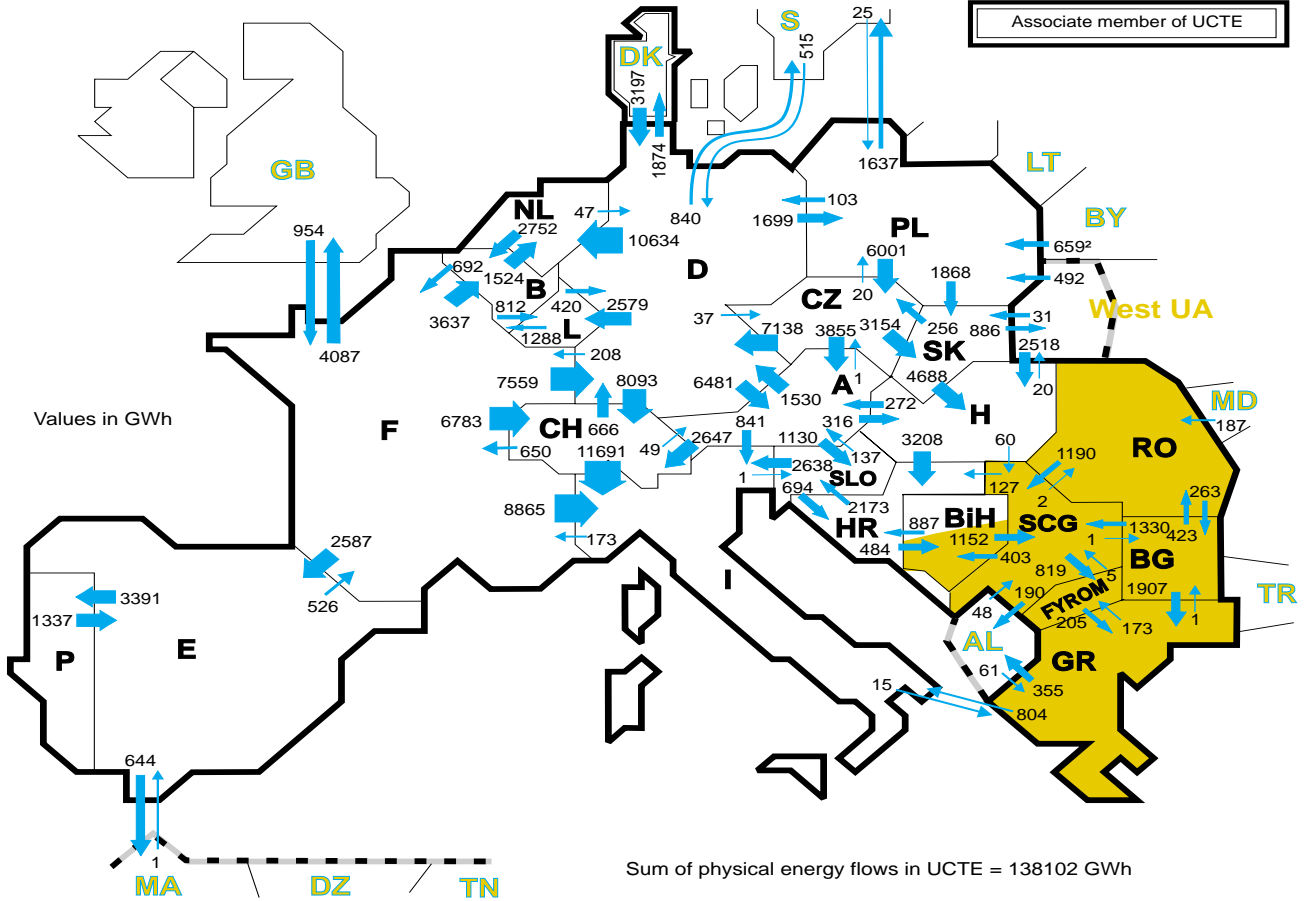

Sum of physical energy flows in UCTE = 138102 GWh

Total = 157323 GWh

T1

| Exporting Countries | Importing countries | | | | | | | | | | | | | | | | | | | | | | | |
|---------------------|---------------------|------|------|-----|-------|------|------|------|-----|-------|------|------|-------|------|------|------|------|------|-----------------|----|-----|----|------------------|------|
| | B | D | E | F | GR | I | SLO | HR | BiH | FYROM | SCG | L | NL | A | P | CH | CZ | H | PL ¹ | SK | RO | BG | III ² | |
| B | - | - | - | 692 | - | - | - | - | - | - | - | 812 | 1524 | - | - | - | - | - | - | - | - | - | - | - |
| D | - | - | - | 208 | - | - | - | - | - | - | - | 2579 | 10634 | 6481 | - | 8093 | 37 | - | 1699 | - | - | - | - | 2714 |
| E | - | - | - | 526 | - | - | - | - | - | - | - | - | - | - | 3391 | - | - | - | - | - | - | - | - | 644 |
| F | 3637 | 7559 | 2587 | - | - | 8865 | - | - | - | - | - | - | - | - | - | 6783 | - | - | - | - | - | - | - | 4087 |
| GR | - | - | - | - | - | 804 | - | - | - | 173 | - | - | - | - | - | - | - | - | - | - | - | - | 1 | 355 |
| I | - | - | - | 173 | 15 | - | 1 | - | - | - | - | - | - | - | - | 0 | - | - | - | - | - | - | - | - |
| SLO | - | - | - | - | - | 2638 | - | 694 | - | - | - | - | - | 137 | - | - | - | - | - | - | - | - | - | - |
| HR | - | - | - | - | - | - | 2173 | 484 | - | - | - | - | - | - | - | - | - | 0 | - | - | - | - | - | - |
| BiH | - | - | - | - | - | - | - | 887 | - | - | 1152 | - | - | - | - | - | - | - | - | - | - | - | - | - |
| FYROM | - | - | - | - | 205 | - | - | - | - | - | 5 | - | - | - | - | - | - | - | - | - | - | - | - | - |
| SCG | - | - | - | - | - | - | - | - | - | - | 127 | 403 | 819 | - | - | - | - | - | - | - | - | 2 | 1 | 190 |
| L | 1288 | 420 | - | - | - | - | - | - | - | - | - | - | - | - | - | - | - | - | - | - | - | - | - | - |
| NL | 2752 | 47 | - | - | - | - | - | - | - | - | - | - | - | - | - | - | - | - | - | - | - | - | - | - |
| A | - | 1530 | - | - | - | 841 | 1130 | - | - | - | - | - | - | - | - | 2647 | 1 | 316 | - | - | - | - | - | - |
| P | - | - | 1337 | - | - | - | - | - | - | - | - | - | - | - | - | - | - | - | - | - | - | - | - | - |
| CH | - | 666 | - | 650 | 11691 | - | - | - | - | - | - | - | - | 49 | - | - | - | - | - | - | - | - | - | - |
| CZ | - | 7138 | - | - | - | - | - | - | - | - | - | - | - | 3855 | - | - | - | 20 | 3154 | - | - | - | - | - |
| H | - | - | - | - | - | - | - | 3208 | - | - | 60 | - | 272 | - | - | - | - | - | 0 | 0 | - | - | - | 20 |
| PL | - | 103 | - | - | - | - | - | - | - | - | - | - | - | - | - | - | 6001 | - | 1868 | - | - | - | - | 1637 |
| SK | - | - | - | - | - | - | - | - | - | - | - | - | - | - | - | - | 256 | 4688 | 0 | - | - | - | - | 886 |
| RO | - | - | - | - | - | - | - | - | - | - | 1190 | - | - | - | - | - | - | 0 | - | - | - | - | 263 | 0 |
| BG | - | - | - | - | 1907 | - | - | - | - | - | 1330 | - | - | - | - | - | - | - | - | - | 423 | - | - | 0 |
| III ² | - | 3712 | 1 | 954 | 61 | - | - | - | - | - | 48 | - | - | - | - | - | - | 2518 | 1176 | 31 | 187 | 0 | - | - |

¹ Corresponds to the supply of a passive island in Poland with Belarus

² Third countries: Albania, Belarus, Denmark (Jutland), Great Britain, Morocco, Republic of Moldava, Sweden, Burshtyn Island part of Ukraine and Republic of Turkey

Regions in parallel operation

21.01.2004, 11:00 a.m. (CET*)

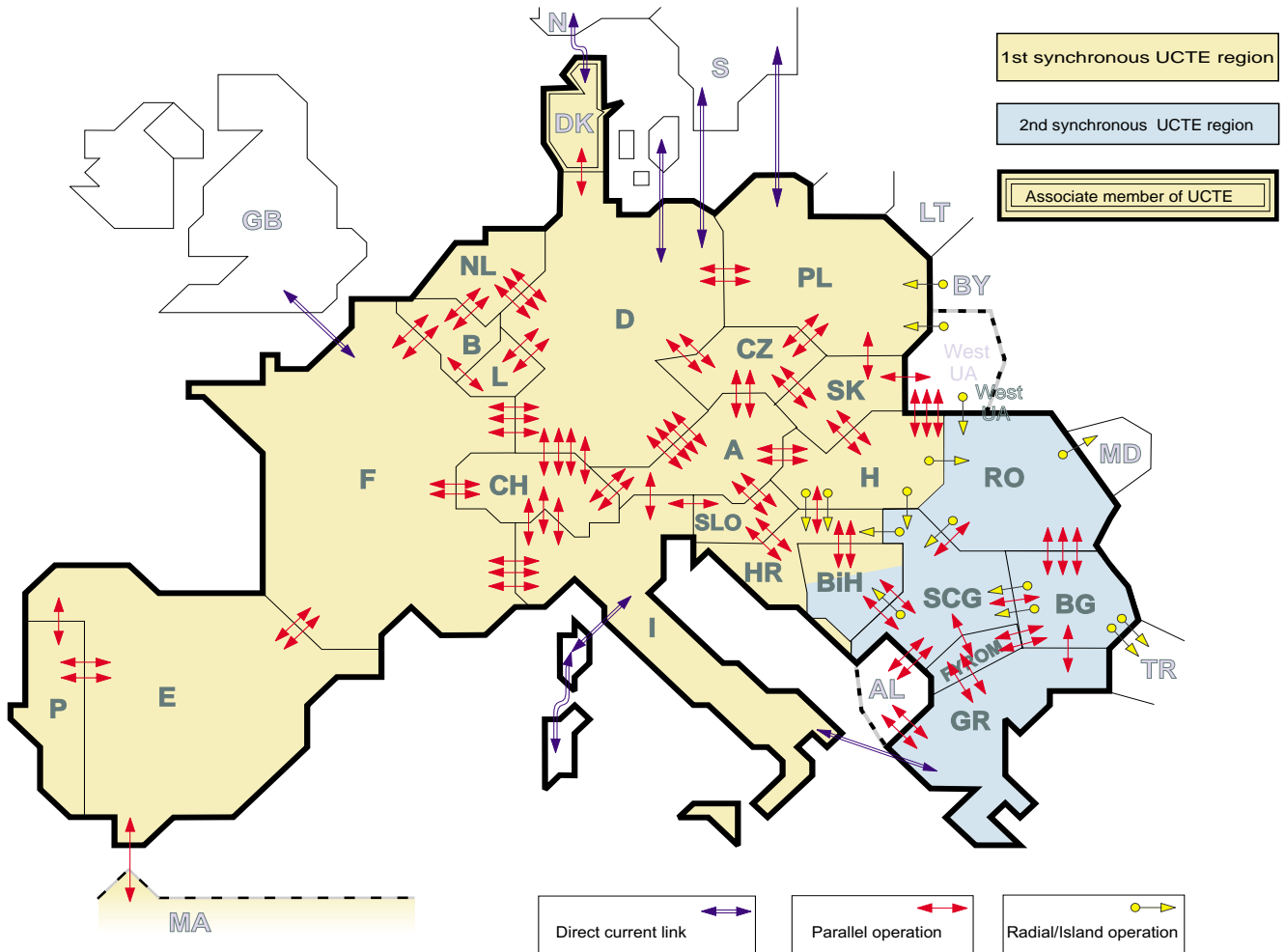

* CET Central European Time

T1 Power produced in parallel operation at 11:00 a.m. (CET) (including autoproduction) in MW

| Day | B | D | E | F | GR | I | SLO | HR | BiH | FYROM | SCG | L | NL | A | P | CH | CZ | H | PL | SK | RO | BG | West UA ¹ | DK |
|------------|-------|-------|-------|-------|------|-------|------|------|------|-------|------|-----|-------|------|------|------|-------|------|-------|------|------|------|----------------------|------|
| 15.10.2003 | 10322 | 74800 | 28271 | 65217 | 5982 | 39183 | 1727 | 1855 | 1237 | 811 | 4647 | 860 | 9331 | 8675 | 5516 | 9770 | 10056 | 4001 | 20716 | 3621 | 6253 | 4685 | 1080 | 2855 |
| 19.11.2003 | 9831 | 77000 | 31035 | 73234 | 6048 | 42737 | 1590 | 2096 | 1725 | 731 | 4471 | 800 | 10461 | 7467 | 5553 | 8807 | 10954 | 4019 | 21654 | 3938 | 6702 | 5442 | 1183 | 2555 |
| 17.12.2003 | 11195 | 77100 | 33378 | 79264 | 7046 | 44422 | 1800 | 2450 | 1801 | 909 | 5232 | 855 | 9709 | 8503 | 6159 | 9087 | 11444 | 4285 | 22116 | 4066 | 7000 | 6268 | 1182 | 2805 |
| 21.01.2004 | 11417 | 77900 | 36012 | 81061 | 6294 | 43611 | 1761 | 2101 | 2047 | 877 | 5384 | 857 | 10429 | 9304 | 5984 | 9497 | 11352 | 4314 | 20708 | 3991 | 7086 | 6243 | 1293 | 2830 |
| 18.02.2004 | 10517 | 78400 | 35157 | 75293 | 7222 | 43192 | 1792 | 2295 | 1763 | 998 | 5651 | 917 | 10291 | 8922 | 5743 | 9571 | 11002 | 4257 | 20443 | 3924 | 7050 | 5956 | 1310 | 2410 |
| 17.03.2004 | 10075 | 75400 | 32646 | 67824 | 6043 | 40046 | 1658 | 2021 | 1748 | 713 | 4164 | 816 | 10208 | 7601 | 6713 | 9533 | 10364 | 3751 | 18801 | 3507 | 6577 | 5001 | 1204 | 2645 |

¹ West UA represents the so-called Burshtyn Island synchronously interconnected with UCTE

Load flows

P = Load

G1 17.12.2003 - 03:00 a.m. (CET) (in MW)

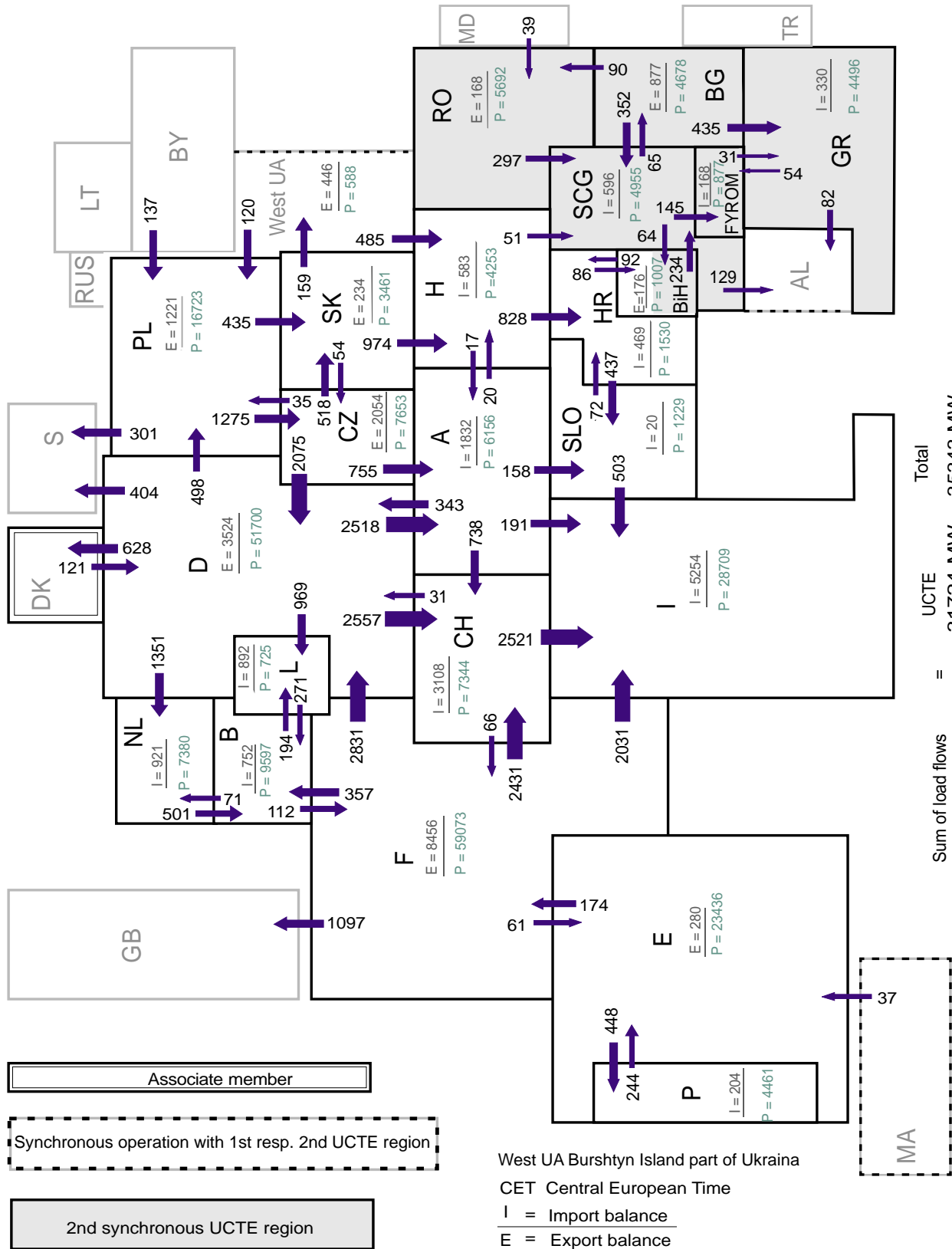

G2 17.12.2003 - 11:00 a.m. (CET) (in MW)

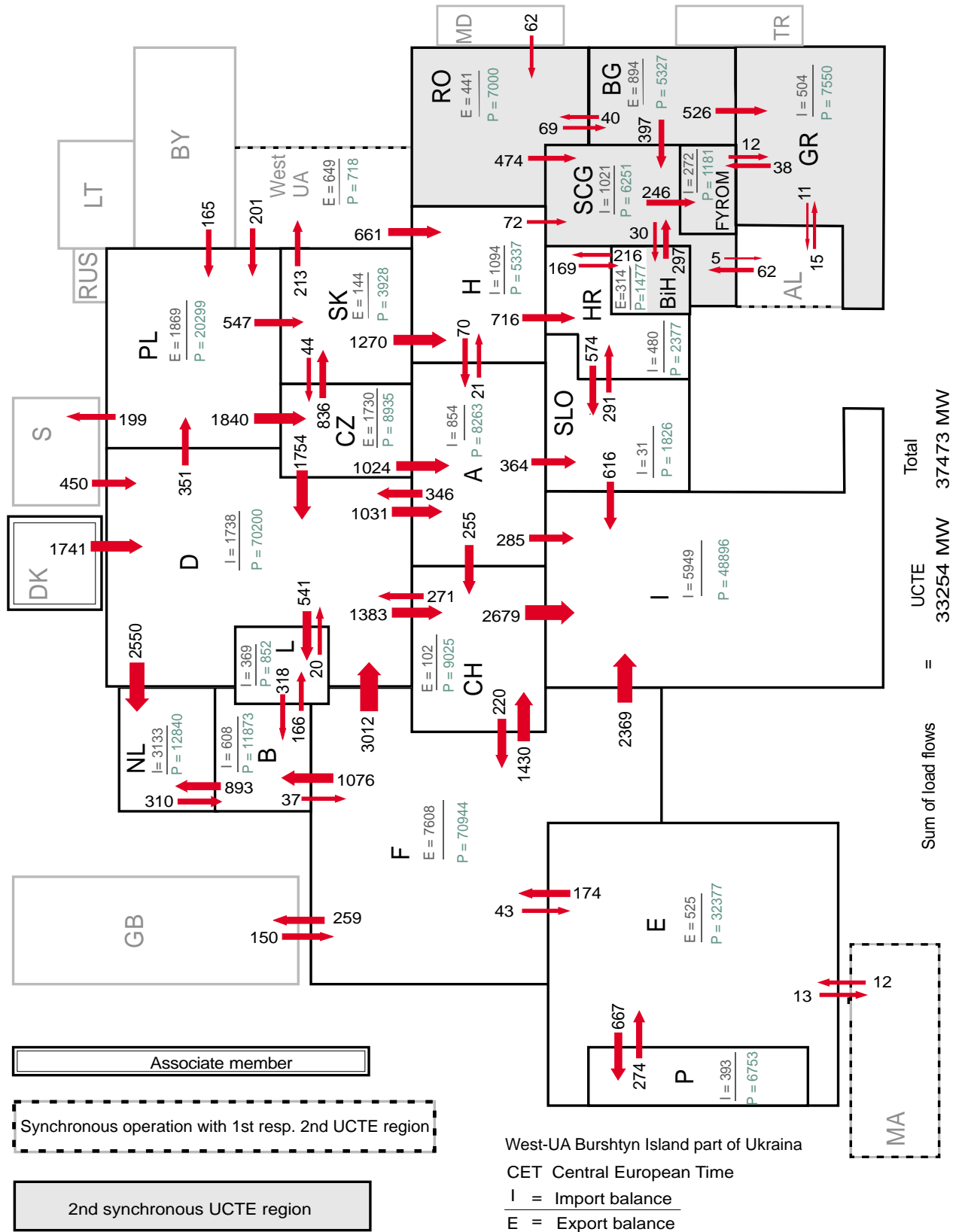

Load flows

P = Load

G3 21.01.2004 - 03:00 a.m. (CET) (in MW)

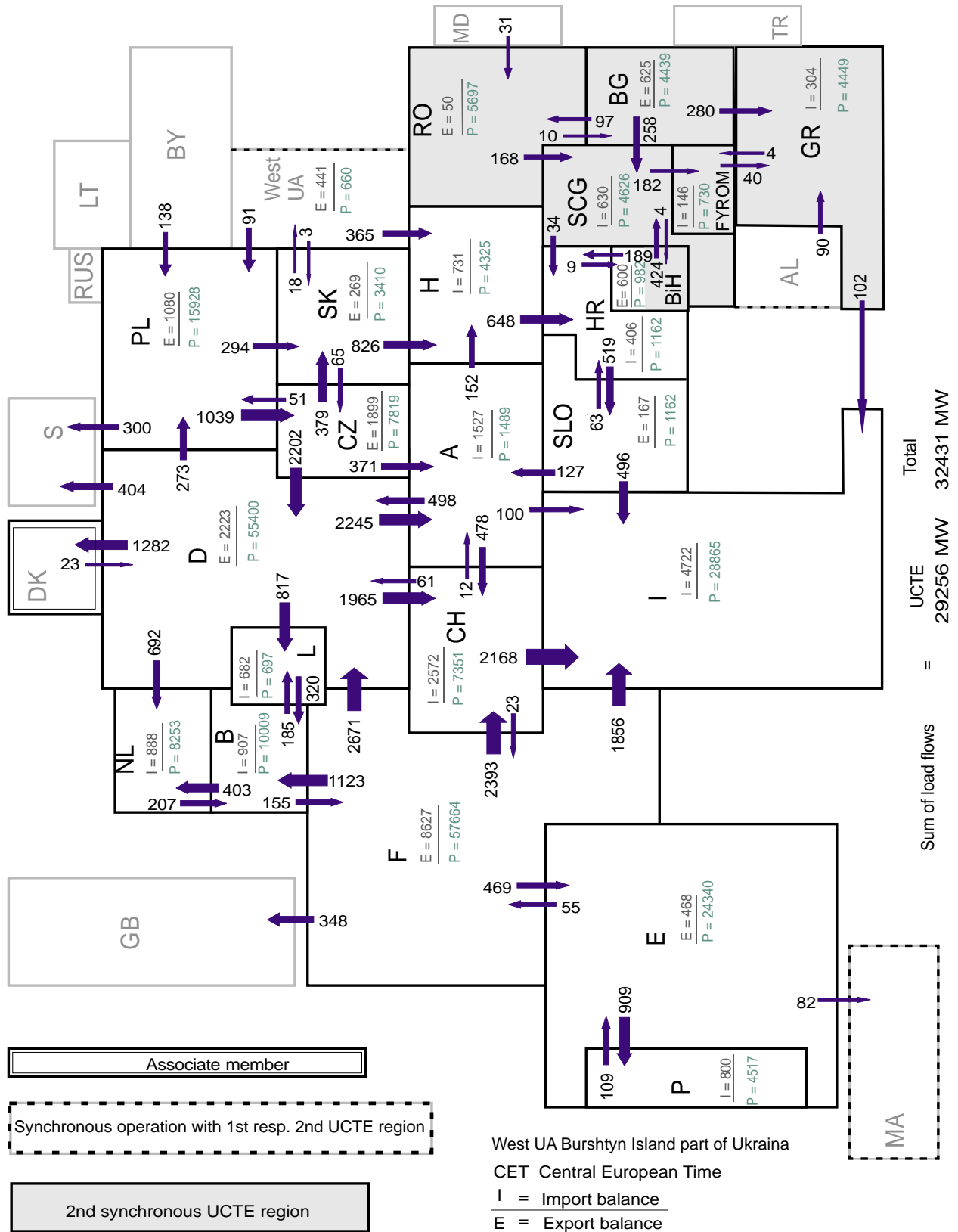

Load flows

P = Load

G4 21.01.2004 - 11:00 a.m. (CET) (in MW)

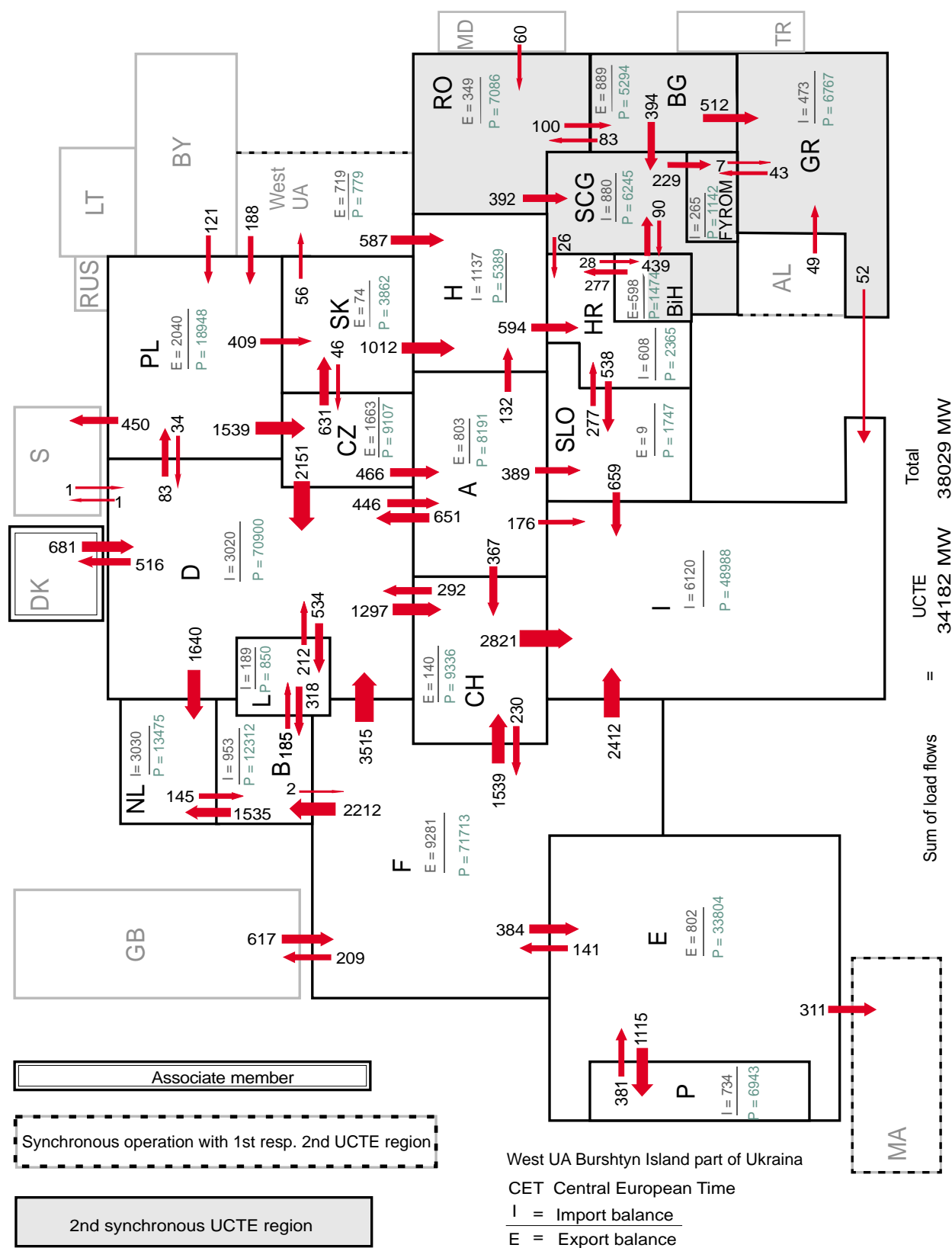

Load diagrams ¹

G1 15.10.2003 (in GW)

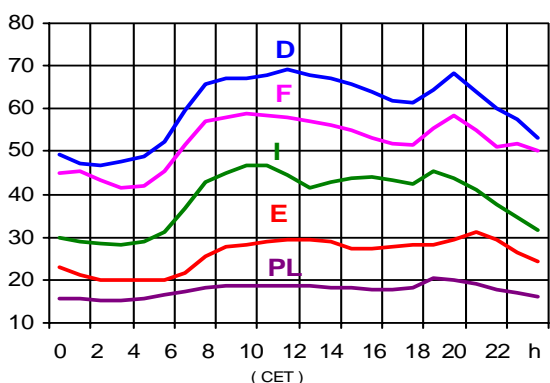

G4 15.10.2003 (in GW)

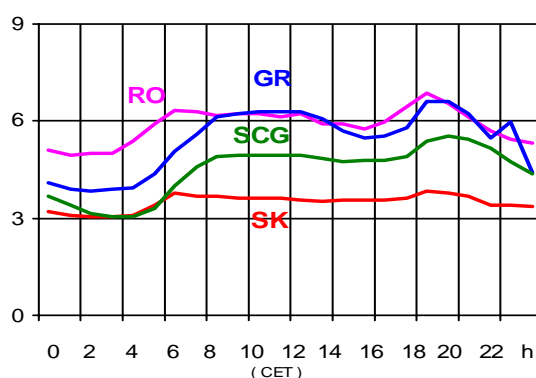

G2 15.10.2003 (in GW)

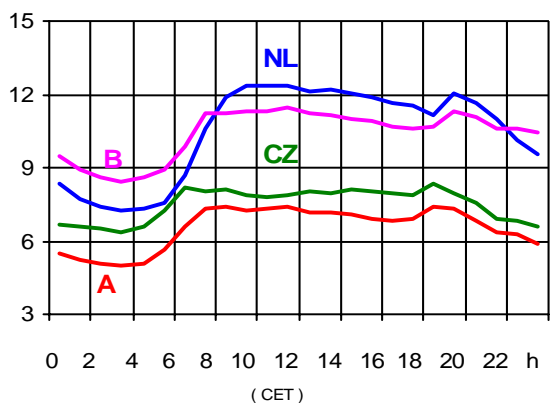

G5 15.10.2003 (in GW)

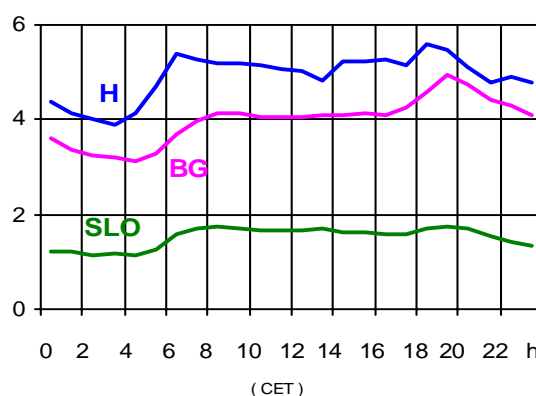

G3 15.10.2003 (in GW)

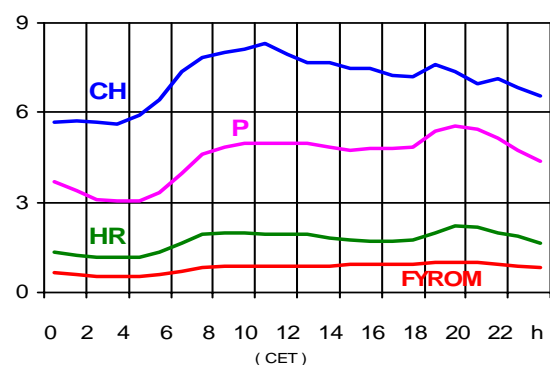

G6 15.10.2003 (in GW)

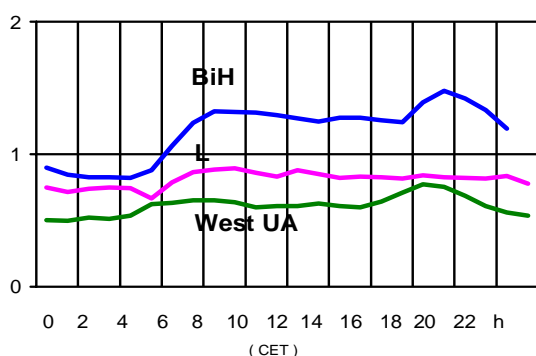

¹ Percentage as referred to total values (%)

| B | D | E | F | GR | I | SLO | HR | BiH | FY ROM | SCG | L | NL | A | P | CH | CZ | H | PL | SK | RO | BG | West UA ² |
|-----|----|----|----|----|-----|-----|-----|-----|--------|-----|----|----|----|----|-----|-----|-----|-----|-----|-----|-----|----------------------|
| 100 | 91 | 94 | 97 | 93 | 100 | 95 | 100 | 100 | 100 | 96 | 99 | 90 | 82 | 91 | 100 | 100 | 100 | 100 | 100 | 100 | 100 | 100 |

² West UA represents the so-called Burshtyn Island synchronously interconnected with UCTE

Load diagrams ¹

G7 19.11.2003 (in GW)

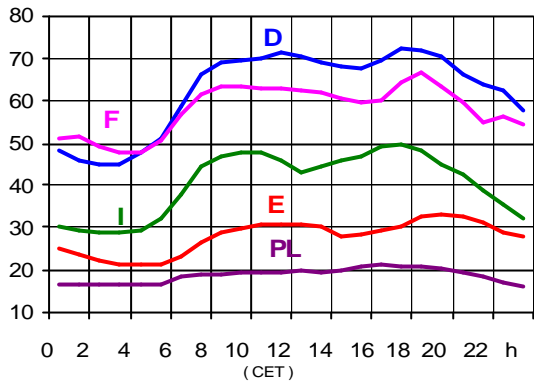

G10 19.11.2003 (in GW)

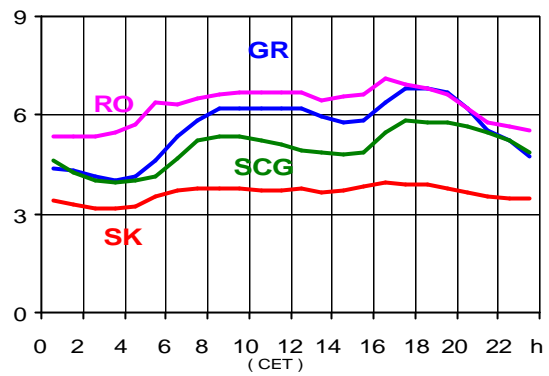

G8 19.11.2003 (in GW)

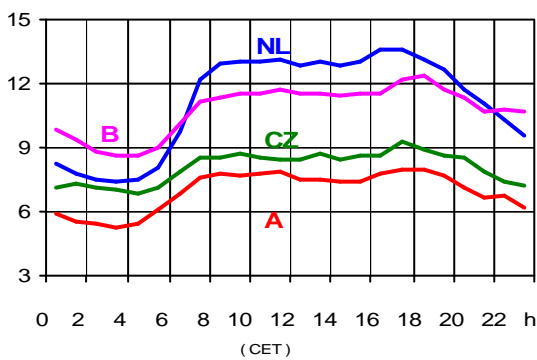

G11 19.11.2003 (in GW)

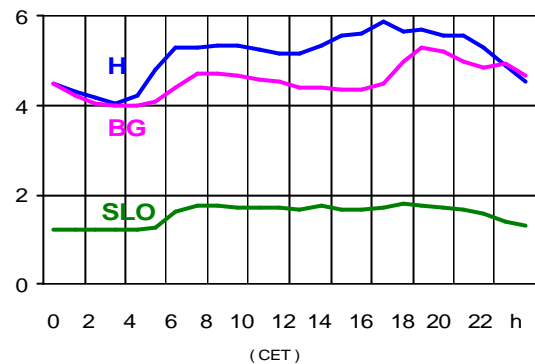

G9 19.11.2003 (in GW)

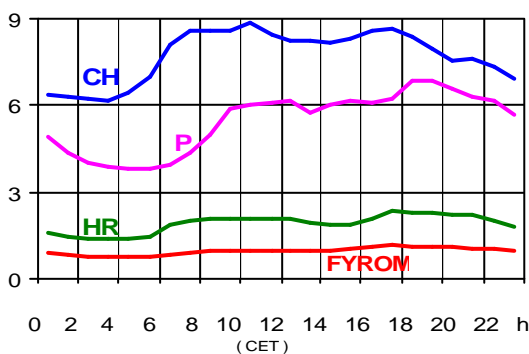

G12 19.11.2003 (in GW)

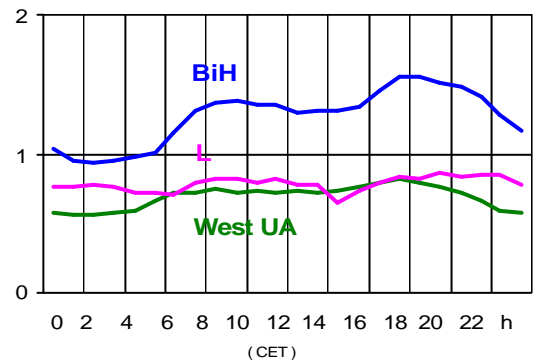

¹ Percentage as referred to total values (%)

| | B | D | E | F | GR | I | SLO | HR | BiH | FYROM | SCG | L | NL | A | P | CH | CZ | H | PL | SK | RO | BG | West UA ² | |
|--|-----|----|----|----|----|-----|-----|-----|-----|-------|-----|----|----|----|----|-----|-----|-----|-----|-----|-----|-----|----------------------|-----|
| | 100 | 91 | 94 | 97 | 93 | 100 | 95 | 100 | 100 | 100 | 96 | 99 | 90 | 82 | 91 | 100 | 100 | 100 | 100 | 100 | 100 | 100 | 100 | 100 |

² West UA represents the so-called Burshtyn Island synchronously interconnected with UCTE

Load diagrams ¹

G13 17.12.2003 (in GW)

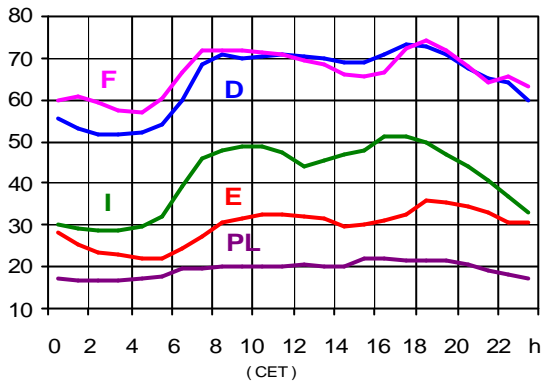

G16 17.12.2003 (in GW)

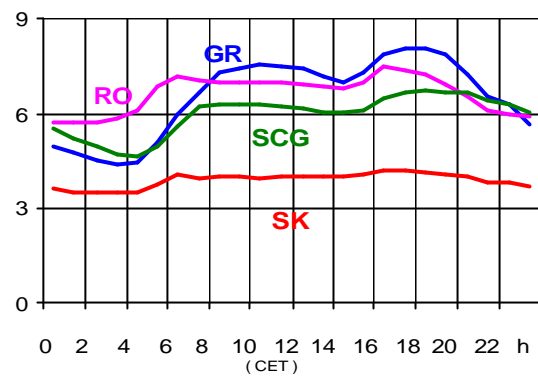

G14 17.12.2003 (in GW)

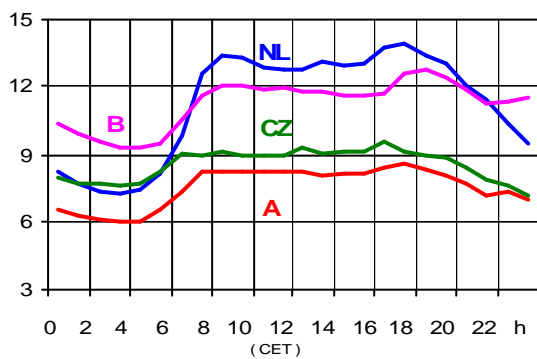

G17 17.12.2003 (in GW)

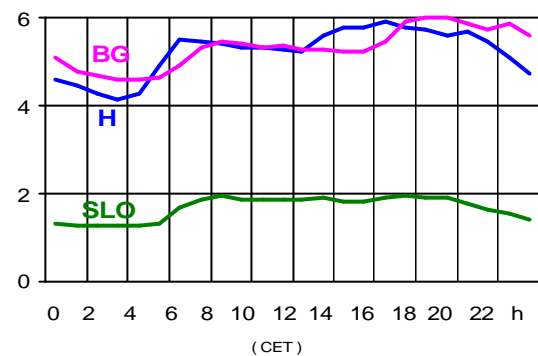

G15 17.12.2003 (in GW)

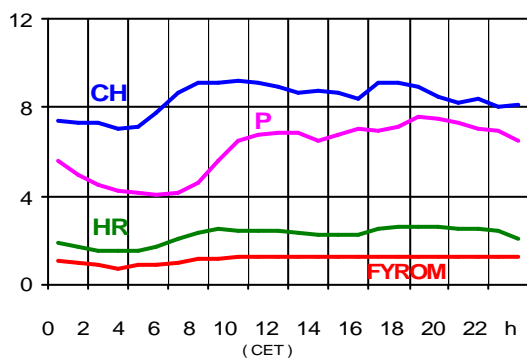

G18 17.12.2003 (in GW)

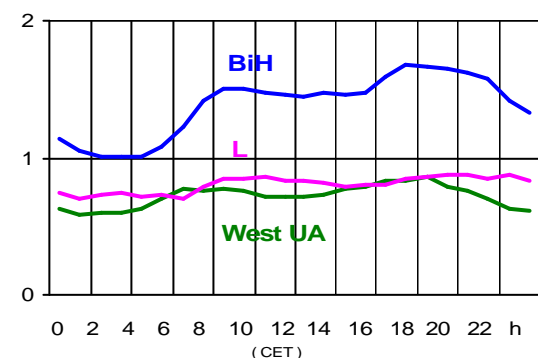

¹ Percentage as referred to total values (%)

| B | D | E | F | GR | I | SLO | HR | BiH | FYROM | SCG | L | NL | A | P | CH | CZ | H | PL | SK | RO | BG | West UA ² | |
|-----|----|----|----|----|-----|-----|-----|-----|-------|-----|----|----|----|----|-----|-----|-----|-----|-----|-----|-----|----------------------|-----|
| 100 | 91 | 94 | 97 | 93 | 100 | 95 | 100 | 100 | 100 | 96 | 99 | 90 | 82 | 91 | 100 | 100 | 100 | 100 | 100 | 100 | 100 | 100 | 100 |

² West UA represents the so-called Burshtyn Island synchronously interconnected with UCTE

Load diagrams ¹

G19 21.01.2004 (in GW)

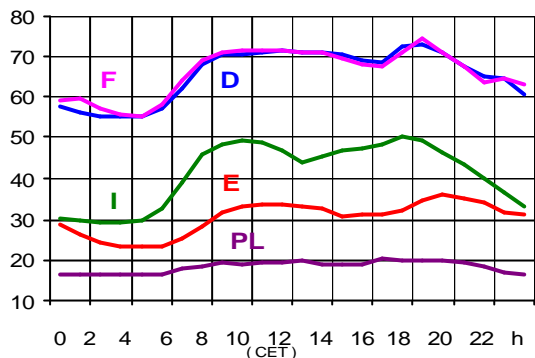

G22 21.01.2004 (in GW)

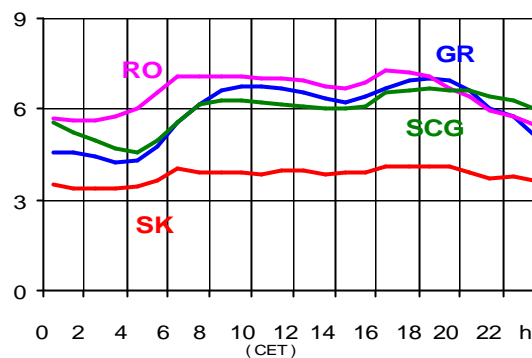

G20 21.01.2004 (in GW)

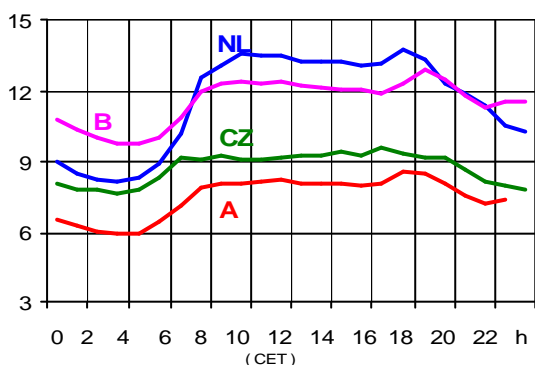

G23 21.01.2004 (in GW)

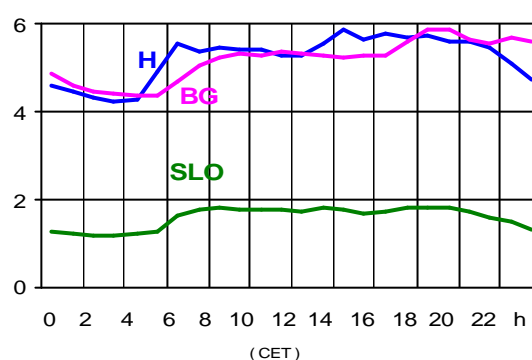

G21 21.01.2004 (in GW)

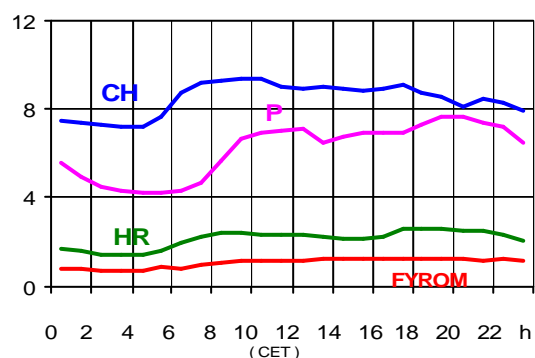

G24 21.01.2004 (in GW)

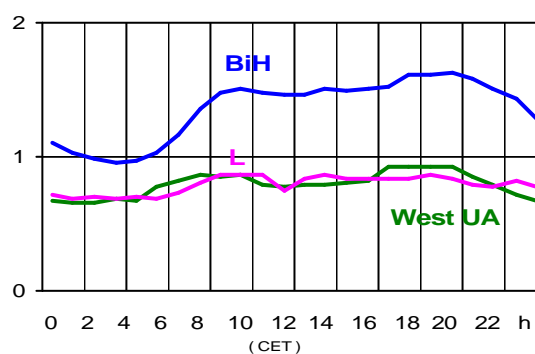

¹ Percentage as referred to total values (%)

| B | D | E | F | GR | I | SLO | HR | BiH | FY ROM | SCG | L | NL | A | P | CH | CZ | H | PL | SK | RO | BG | West UA ² | |
|-----|----|----|----|----|-----|-----|-----|-----|--------|-----|----|----|----|----|-----|-----|-----|-----|-----|-----|-----|----------------------|-----|
| 100 | 91 | 94 | 97 | 93 | 100 | 95 | 100 | 100 | 100 | 96 | 99 | 90 | 82 | 91 | 100 | 100 | 100 | 100 | 100 | 100 | 100 | 100 | 100 |

² West UA represents the so-called Burshtyn Island synchronously interconnected with UCTE

Load diagrams ¹

G25 18.02.2004 (in GW)

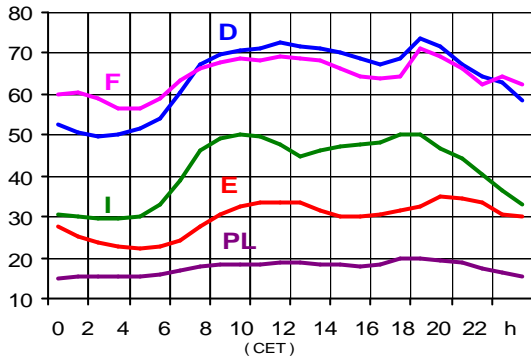

G28 18.02.2004 (in GW)

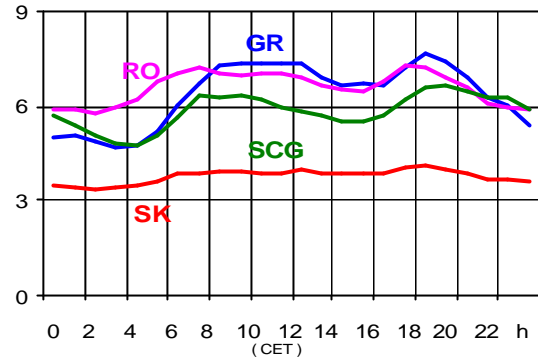

G26 18.02.2004 (in GW)2

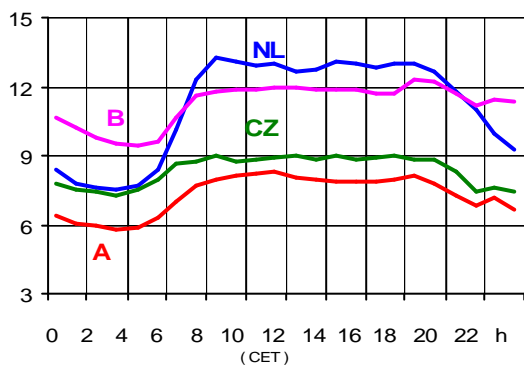

G29 18.02.2004 (in GW)

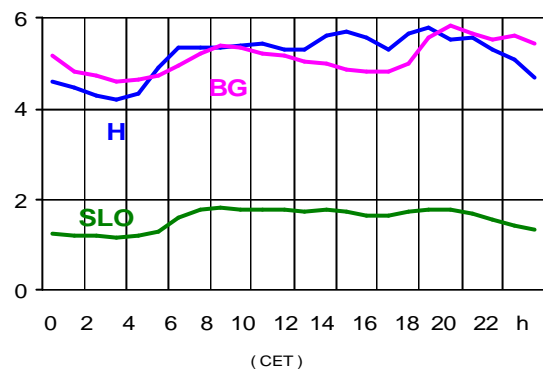

G27 18.02.2004 (in GW)

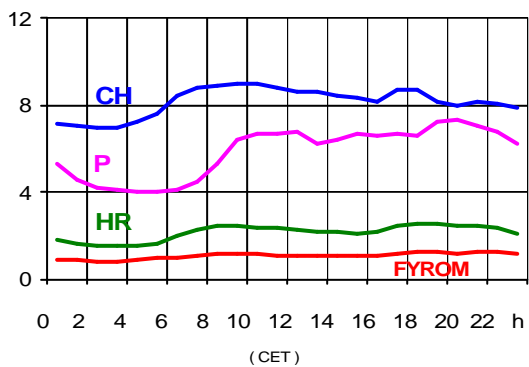

G30 18.02.2004 (in GW)

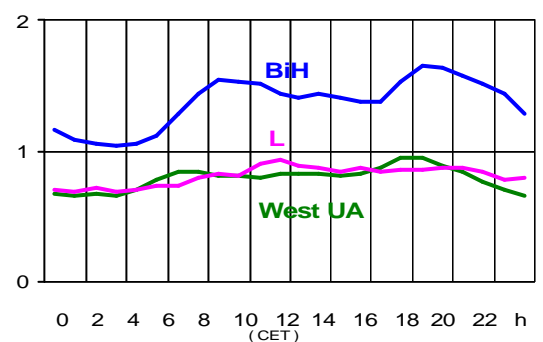

¹ Percentage as referred to total values (%)

| B | D | E | F | GR | I | SLO | HR | BiH | FYROM | SCG | L | NL | A | P | CH | CZ | H | PL | SK | RO | BG | West UA ² |
|-----|----|----|----|----|-----|-----|-----|-----|-------|-----|----|----|----|----|-----|-----|-----|-----|-----|-----|-----|----------------------|
| 100 | 91 | 94 | 97 | 93 | 100 | 95 | 100 | 100 | 100 | 96 | 99 | 90 | 82 | 91 | 100 | 100 | 100 | 100 | 100 | 100 | 100 | 100 |

Load diagrams ¹

G31 17.03.2004 (in GW)

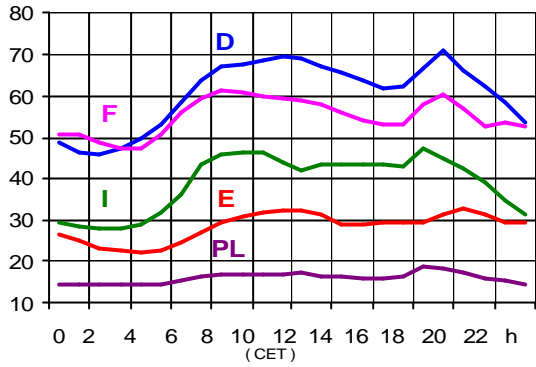

G34 17.03.2004 (in GW)

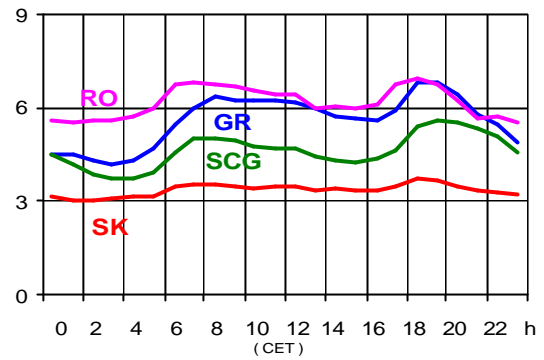

G32 17.03.2004 (in GW)

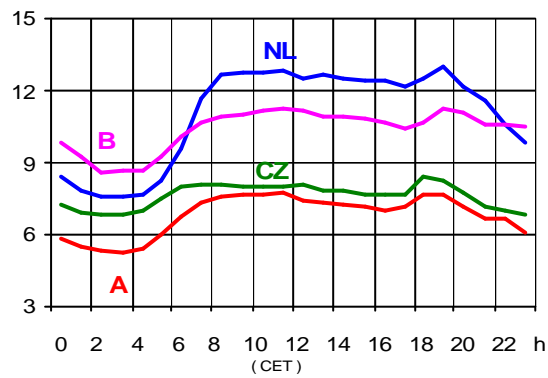

G35 17.03.2004 (in GW)

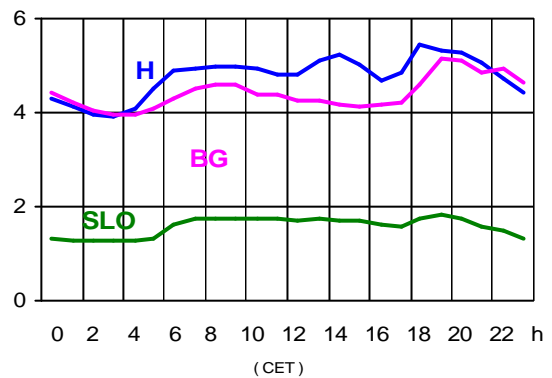

G33 17.03.2004 (in GW)

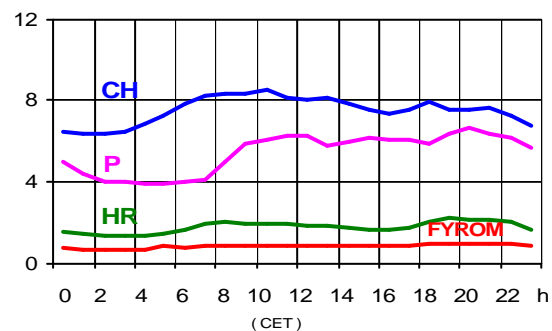

G36 17.03.2004 (in GW)

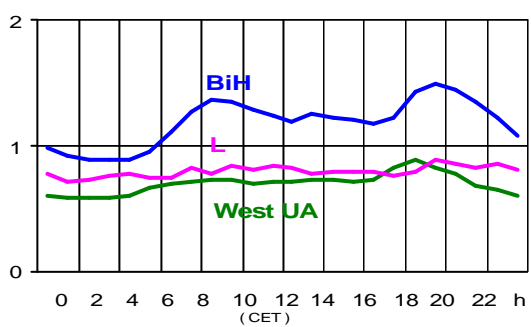

¹ Percentage as referred to total values (%)

| B | D | E | F | GR | I | SLO | HR | BiH | FY ROM | SCG | L | NL | A | P | CH | CZ | H | PL | SK | RO | BG | West UA ² |
|-----|----|----|----|----|-----|-----|-----|-----|--------|-----|----|----|----|----|-----|-----|-----|-----|-----|-----|-----|----------------------|
| 100 | 91 | 94 | 97 | 93 | 100 | 95 | 100 | 100 | 100 | 96 | 99 | 90 | 82 | 91 | 100 | 100 | 100 | 100 | 100 | 100 | 100 | 100 |

² West UA represents the so-called Burshtyn Island synchronously interconnected with UCTE

Load diagrams ¹

G 37

Monthly load diagrams UCTE ³

(in GW)

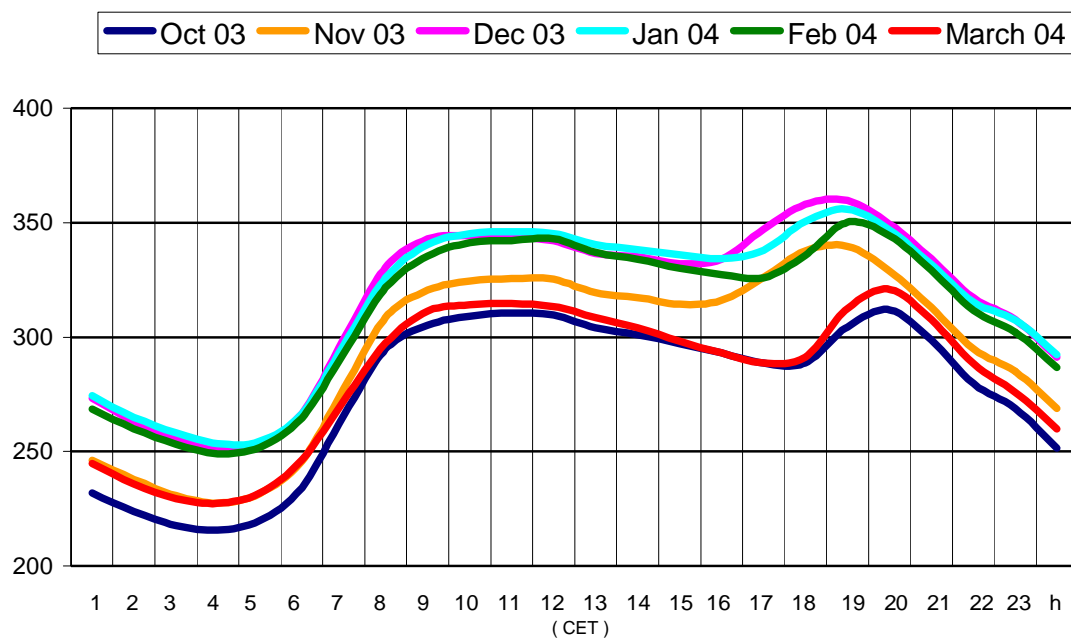

¹ Percentage as referred to total values (%)

| B | D | E | F | GR | I | SLO | HR | BiH | FY ROM | SCG | L | NL | A | P | CH | CZ | H | PL | SK | RO | BG | West UA ² | |
|-----|----|----|----|----|-----|-----|-----|-----|-----------|-----|----|----|----|----|-----|-----|-----|-----|-----|-----|-----|-------------------------|-----|
| 100 | 91 | 94 | 97 | 93 | 100 | 95 | 100 | 100 | 100 | 96 | 99 | 90 | 82 | 91 | 100 | 100 | 100 | 100 | 100 | 100 | 100 | 100 | 100 |

² West UA represents the so-called Burshtyn Island synchronously interconnected with UCTE

³ As sum load values of all countries on each third Wednesday in the winter period

UCTE System Adequacy Retrospect 2003

Executive summary

The UCTE system has experienced in 2003 quite difficult situations which have put forward the stakes of system security and could let this year be considered as the first of a new era of the European power system. Of course the Italian blackout is undoubtedly the most remarkable event. But the hot summer which has led in June to rolling load shedding in Italy and to very tensed situations in other countries should remind all market players and authorities that adequate level of investment and optimal management of the available resources are the prerequisite to allow consumers to take the benefits of the market opening process.

This UCTE System Adequacy retrospect report aims at :

- providing all players of the European power market with an overall overview of the operational conditions of the year 2003;
- showing the main incidents that have affected the UCTE system and their possible influence on system security.
- providing all European electricity market players with an overview of the situation and main changes in the UCTE Transmission grids ; to this respect an estimation of the criticality of congestions on interconnection tie-lines is for the first time available.

2003 Retrospect includes data from Bulgaria, Romania and Burshtyn Island which have joined UCTE in May 2003. Nevertheless data at the scale of the former UCTE perimeter are also provided in order to make comparison with previous year figures.

Energy Balance

Consumption in UCTE system reached 2376.1 TWh in 2003. The 3.1% growth rate is higher than the 0.6% to 2.4% increases observed the previous years. A high increase during summer is observed in many countries ; it partly results from the extremely hot temperature observed during this summer.

Concerning generation, "new renewable sources" contribution has increased by 21%; together with hydro-generation, it represents 15 % of the consumption (0.5% more than in 2002).

Power Balance

Generating capacity has increased by 1.6%. Remaining capacity reached its lowest level in February, June and July with around 9% of the generating capacity. Tense situations have been observed in some countries in summer due to extremely high temperatures which have pushed the demand while generation was restricted due to the poor cooling conditions of the power plants. This led in June to voluntary rolling shortages in Italy while in July and August margins were very low in France.

Transmission System Adequacy

Of course the Italian blackout which occurred the 28th of September is the main event of the year. UCTE has already published two reports on this event (the final report is available on UCTE web site at http://www.ucte.org/pdf/News/20040427_UCTE_IC_Final_report.pdf). But in other occasions the UCTE security rules were violated due to high flows on the system and a single important outage could have had severe consequences : it concerns the flows across the Belgian system in March, April, and July and the Austrian north to south 220kV lines in Winter. For the first time this UCTE report provides an overview of the congestion on the interconnection tie-lines. Italy, Poland, Czech Republic, Austria and Hungary face the most critical congestions but very frequent congestions are also observed on the international tie lines in France, Germany and Slovenia. The review of the methods used to allocate the capacities shows that auctions are more and more developed.

Market development

Exchanges amount to 568.8 TWh, representing 23.9% of the consumption. Considering the former UCTE perimeter a sensible increase can be observed over the 2001-2003 period. Compared to the previous years price differences between the Spanish and English markets on one hand, and the French and German market on the other hand have been considerably reduced.

The main changes concerning exports are the decrease in France and an increase in Germany and Czech Republic. As far as imports are concerned main changes are the increase in Austria and the decrease in Spain.

1. Introduction

1.1 Objectives

System adequacy retrospect is this year undertaken in a completely changed framework as compared to previous years. Whereas all the last years long attention to power systems was mainly focused on market opening, the year 2003 has dramatically put forward system reliability concerns. As far as generation adequacy is concerned, the rolling load shedding in Italy in June and the critical situations observed during this summer in many countries have shown that adequate investment in generating capacities and optimal management of available resources were prerequisites to let consumers fully benefit of the market opening process. In the same time, both exceptional black-outs which have occurred in the USA and in Italy have highlighted the stakes of system security control in large power systems.

This UCTE System Adequacy Retrospect aims at:

- presenting the main results concerning generation and demand in the UCTE system,
- describing the main incidents that have affected the system and their possible influence on system security; however, as far as the black-out which occurred in Italy on September the 28th is concerned, specific reports are available on UCTE web site;
- providing all European electricity market players with an overview of the main changes in the UCTE Transmission grids;
- giving from this year an overview of the criticality of congestions on international interconnections.

All these information, completed by comments and notes of national correspondents provide all players on the European power market with an overall overview of the operational conditions of the year 2003. Additional information concerning network and generation developments and significant events which occurred in the UCTE network in the year 2003 can also be found in the report of the UCTE sub-group "TSO-Forum" (see UCTE web site – living grid).

Note: the following CIGRE definitions are used:

Reliability: a general term encompassing all the measures of the ability of the system, generally given as numerical indices, to deliver electricity to all points of utilisation within acceptable standards and in the amounts desired. Power system reliability (comprising generation and transmission facilities) can be described by two basic and functional attributes: adequacy and security.

Adequacy: a measure of the ability of the power system to supply the aggregate electric power and energy requirements of the customers within component ratings and voltage limits, taking into account planned and unplanned outages of system components. Adequacy measures the capability of the power system to supply the load in all the steady states in which the power system may exist considering standards conditions.

Security: a measure of power system ability to withstand sudden disturbances such as electric short circuits or unanticipated losses of system components or load conditions together with operating constraints. Another aspect of security is system integrity, which is the ability to maintain interconnected operations. Integrity relates to the preservation of interconnected system operation, or the avoidance of uncontrolled separation, in the presence of specified severe disturbances.

The above definitions are described in detail in the following two CIGRE reports:

- Power System Reliability Analysis – Application Guide, Paris, 1987,
- Power System Reliability Analysis – Composite Power System Reliability Evaluation, Paris, 1992.

1.2 Content of the retrospect

The retrospect for 2003 includes power and energy balances for the following countries and electricity systems:

| | |
|---|----------------------|
| Belgium (B) | Luxembourg (L) |
| Germany (D) | The Netherlands (NL) |
| Spain (E) | Austria (A) |
| France (F) | Portugal (P) |
| Greece (GR) | Switzerland (CH) |
| Italy (I) | Czech Republic (CZ) |
| Slovenia (SLO) | Hungary (H) |
| Croatia (HR) | Poland (PL) |
| Bosnia-Herzegovina (BiH) | Slovak Republic (SK) |
| Former Yugoslav Republic of Macedonia (FYROM) | Romania (RO) |
| Serbia and Montenegro (SCG) | Bulgaria (BG) |

All these countries, and Western Ukraine (so called Burshtyn Island BI-UA) are taken into account in this year's retrospect. Since last year Bosnia-Herzegovina was not taken into account, and data from Romania, Bulgaria and Burshtyn Island were reported in Appendix, results will also be shown with last year's UCTE perimeter when necessary. In order to allow the simultaneous consideration of capacity being operated in parallel at the same frequency in the various member countries, the third Wednesday of each month at 11:00 a.m. (Central European Time) has been selected as the reference point for the balance. For statistical reasons, data on electricity supplies in a number of countries have not been completely recorded. Depending upon the country concerned, the sectors included in this analysis represent between 85% (the Netherlands) and 100% of total consumption. In order to ensure the coherence of the power and energy balances, the retrospect for the energy balance generally relates to the same statistical base as the power balance.

In this respect, changes in data collection have been introduced this year in Germany and in Poland. For this reason, the data provided in this report for the year 2002 are not comparable with last year data. All data indicated in the power and energy balances are net values.

Note: statistical data used for the year 2003 are in most countries still provisional, as "official" data are available only many months later. For the same reason data of the year 2002 can differ from the data published in last year report because they have been updated in the meantime.

2. Summary of Results

In the following tables, retrospect data for 2003 are compared to the results of the 2002 retrospect.

Energy balance

The main overall results are summarised in TABLE 1.

| Table 1 | UCTE Energy balance, retrospect 2003 | | | | Results in TWh | |
|--|--|---------------------------|------------------------------|----------------------------|----------------------------|--|
| | Situation ¹ 2002* TWh | Situation 2003* TWh | Changes 2002-2003* TWh | Changes 2002-2003* % | Situation 2003** TWh | |
| Generation | | | | | | |
| Hydro power stations | 282.4 | 292.1 | 9.7 | 3.4 | 312.5 | |
| Nuclear power stations | 759.0 | 767.6 | 8.6 | 1.1 | 788.2 | |
| Conventional thermal power stations | 1164.0 | 1204.6 | 40.6 | 3.5 | 1269.6 | |
| Renewable energy sources | 44.2 | 53.5 | 9.2 | 20.9 | 33.8 | |
| Not clearly identifiable energy sources | 11.5 | 8.8 | - 2.7 | - 23.5 | 8.8 | |
| Total generation | 2261.6 | 2326.5 | 64.9 | 2.9 | 2433.0 | |
| Physical exchanges balance (imports-exports) | - 3.2 | - 1.6 | 1.6 | - 50.8 | - 13.5 | |
| Consumption from pumped storage | 44.7 | 42.8 | - 1.9 | - 3.9 | 43.3 | |
| Consumption | 2213.7 | 2282.1 | 68.4 | 3.1 | 2376.1 | |

* excluding BiH, RO, BG and West UA

** included BiH, RO and West UA

Considering the same perimeter as previous year, total generation in UCTE showed in 2003 an increase of 64.9 TWh compared to 2002 (2.9%). The increase in the UCTE consumption accounts for 68.4 TWh (+3.1%).

Production from hydroelectric plants showed an increase by 9.7 TWh i.e. 3.4%, due to better hydro conditions.

Production from renewable sources has increased by 20.9 % when compared to the 2002 situation. When the hydro power is taken into account, the total renewable production reached 345.6 TWh which represents **14.8%** (15.0% when taking into account new perimeter) of the total consumption in 2003 for the UCTE, against 14.4% the previous year.

This point has to be kept in mind when looking at the new European environmental requirements (Directive 2001/77/EC, September the 27th 2001, on the promotion of electricity produced from renewable energy sources) which ask for an average 22% of the total consumption satisfied by renewable sources.

Note: although hydroelectric power is a renewable energy source (according also to the definition from the relevant EU Directive no 2001/77/EC dated September 27th, 2002), it is shown separately on the grounds that hydroelectric capacity is foreseeable and contributes substantially to the reserve capacity available to transmission system operators.

¹ Values of last year's Retrospect for 2002 have been updated so as to take into account definitive values, and 2003 statistical perimeters (e.g. for Germany, perimeter of generation and consumption has been enlarged)

According to the UCTE Power Balance methodology, "Renewable energy sources" and "not clearly identifiable energy sources" comprise capacities which, as a function of the primary energy used, do not correspond to the categories of hydro power stations, nuclear power stations and conventional thermal power stations, and which can be used for public/general supply and can thus be transported across the distribution and/or transmission networks.

"Renewable energy sources" comprise the following primary energies:

1. wind energy,
2. photovoltaics/solar energy,
3. geothermal energy,
4. energy from biomass and waste (e. g. biogas, damp gas, municipal waste, industrial waste, wood and waste of wood).

Power balance

The main overall results are shown in TABLE 2. Values are given in GW.

| Table 2 | UCTE Power balance, retrospect 2003 | | | Results in GW | |
|------------------------------------|-------------------------------------|----------------------|--------------------------|-------------------------|-----------------------|
| | December 2002* GW | December 2003* GW | Changes 2002-2003* GW | Changes 2002-2003* % | December 2003** GW |
| Generating capacity | 525.6 ² | 534.0 | 8.5 | 1.6 | 569.1 |
| Guaranteed capacity | 394.5 | 392.7 | - 1.8 | - 0.4 | 414.2 |
| Load at 11:00 a.m. | 335.4 | 333.3 | - 2.1 | - 0.6 | 348.2 |
| Balance of physical exchanges | 1.0 | 3.7 | 2.7 | 263.9 | 1.6 |
| Remaining capacity, with exchanges | 60.1 | 63.1 | 3.0 | 5.0 | 67.7 |

* excluding BiH, RO, BG and West UA

** included BiH, RO, BG and West UA

In the UCTE, according to last year's perimeter, the results of the "Power Balance – Retrospect for 2003" for the month of December show an increase in the generating capacity (+1.6%), but a decrease in the guaranteed capacity (-0.4%) in comparison to the previous year.

Concerning changes in the reference load, a decrease by -0.6% can be noticed as compared to 2002 at the same perimeter ; it results not only from the general trend but also from the differences of meteorological conditions compared to the previous year.

The remaining capacity, including the physical exchanges, has increased by 5.0%.

Considering the whole year, the remaining capacity has decreased to 8.8% of the installed capacity in July, the lowest level since December 2001. This reflects the effect of the high temperature both on the demand and on the generating capacities ; negative values (i.e. countries relying on imports) were observed in Serbia and Montenegro all the year long as well as in Hungary in June and July and in Italy in July.

² Values of last year's Retrospect for 2002 have been updated so as to take into account definitive values, and 2003 statistical perimeters (e.g. for Poland since this year, values are net values and no more gross values)

3. Power Balance: detailed Results

3.1 National generating capacity

The maximum national generating capacity represents the maximum potential net generating capacity of electric utility companies and auto-producers in the countries concerned.

Movements in national generating capacity between December 2002 and December 2003 are shown in TABLE 3:

| Country | National generating capacity, Situation December 2003 | | | | | | Results in GW | |
|-------------|---|------------------------|---------------------------------------|----------------------------------|--------------------------------|------------------------------|--------------------------------|-------------------|
| | Hydro power stations | Nuclear power stations | Convention all thermal power stations | Renewable sources power stations | Not clearly identified sources | National generating capacity | Changes 2002-2003 ³ | Changes 2002-2003 |
| | GW | GW | GW | GW | GW | GW | GW | % |
| B | 1.4 | 5.8 | 8.2 | 0.2 | 0.1 | 15.7 | 0.0 | 0.3 |
| D | 8.1 | 20.5 | 67.7 | 14.9 | 0.0 | 111.2 | 2.0 | 1.8 |
| E | 18.1 | 7.7 | 27.9 | 6.1 | 0.0 | 59.8 | 2.6 | 4.5 |
| F | 24.3 | 63.4 | 23.2 | 0.3 | 0.0 | 111.1 | - 0.2 | - 0.2 |
| GR | 3.1 | 0.0 | 7.1 | 0.3 | 0.0 | 10.4 | 0.4 | 3.9 |
| I | 20.5 | 0.0 | 55.3 | 1.5 | 0.0 | 77.3 | 0.7 | 1.0 |
| SLO | 0.8 | 0.7 | 1.3 | 0.0 | 0.0 | 2.8 | 0.0 | 1.6 |
| HR | 2.1 | 0.0 | 2.0 | 0.0 | 0.0 | 4.0 | 0.3 | 8.4 |
| BiH | 2.0 | 0.0 | 1.8 | 0.0 | 0.0 | 3.8 | 0.0 | 0.0 |
| FYROM | 0.4 | 0.0 | 0.9 | 0.0 | 0.0 | 1.3 | 0.0 | 0.0 |
| SCG | 3.5 | 0.0 | 6.4 | 0.0 | 0.0 | 9.9 | 0.0 | 0.0 |
| L | 1.1 | 0.0 | 0.5 | 0.0 | 0.0 | 1.6 | 0.0 | 1.8 |
| NL | 0.0 | 0.4 | 17.5 | 1.2 | 0.5 | 19.8 | 0.2 | 1.1 |
| A | 11.2 | 0.0 | 5.6 | 0.4 | 0.0 | 17.2 | 0.3 | 1.8 |
| P | 4.6 | 0.0 | 5.7 | 0.4 | 0.0 | 10.7 | 0.5 | 5.0 |
| CH | 13.2 | 3.2 | 0.6 | 0.3 | 0.0 | 17.3 | 0.0 | 0.0 |
| CZ | 2.1 | 3.5 | 10.5 | 0.0 | 0.0 | 16.2 | 1.0 | 6.6 |
| H | 0.0 | 1.8 | 5.5 | 0.0 | 0.6 | 8.0 | 0.2 | 2.7 |
| PL | 2.2 | 0.0 | 29.7 | 0.1 | 0.0 | 31.6 | 0.2 | 0.8 |
| SK | 2.4 | 2.6 | 2.3 | 0.0 | 0.7 | 8.1 | 0.0 | 0.0 |
| RO | 6.0 | 0.7 | 9.8 | 0.0 | 0.0 | 16.4 | - 0.9 | - 5.1 |
| BG | 2.7 | 2.9 | 6.7 | 0.0 | 0.0 | 12.3 | - 0.9 | - 6.7 |
| UCTE | 130.0 | 113.1 | 298.3 | 25.8 | 1.9 | 569.1 | 6.7 | 1.2 |
| BI-UA | 0.0 | 0.0 | 2.5 | 0.0 | 0.0 | 2.5 | 0.0 | 0.0 |

At the end of 2003, the national generating capacity in the UCTE countries was 569.1 GW. This value represents an increase of 6.7 GW compared to the previous year (1.2%), when taking into account 2003 perimeter.

The most noticeable changes occurred in Spain (national capacity in Spain has increased by 2.6 GW), Germany (+2 GW) and Czech Republic (+1 GW).

³changes for UCTE are calculated with this year's perimeter

The generating plant mix and the increase in capacity are shown in TABLE 4:

| Table 4 | Generating plant mix and changes in capacity | | | | | | Results in GW | | |
|-------------------------------------|--|--------------|----------------|--------------|------------|------------|-----------------|--------------|--|
| | Capacity | | Capacity | | Changes | | Capacity | | |
| | December 2002* | % | December 2003* | % | 2002-2003 | % | December 2003** | % | |
| | GW | | GW | | GW | | GW | | |
| Hydro power stations | 118.8 | 22.6 | 119.2 | 22.3 | 0.4 | 0.4 | 130.0 | 22.8 | |
| Nuclear power stations | 109.0 | 20.7 | 109.6 | 20.5 | 0.6 | 0.6 | 113.1 | 19.9 | |
| Conventional thermal power stations | 274.5 | 52.2 | 277.5 | 52.0 | 3.1 | 1.1 | 298.3 | 52.4 | |
| Renewable sources power stations | 22.4 | 4.3 | 25.8 | 4.8 | 3.4 | 15.0 | 25.8 | 4.5 | |
| Not clearly identified sources | 1.0 | 0.2 | 1.9 | 0.4 | 0.9 | 97.0 | 1.9 | 0.3 | |
| Generating capacity | 525.6 | 100.0 | 534.0 | 100.0 | 8.5 | 1.6 | 569.1 | 100.0 | |

* excluding BiH, RO, BG and BI-UA

** included BiH, RO, BG and BI-UA

The most remarkable change is the continuous increase of generation from renewable sources which increased by 15% in 2003. As in the previous years, the most significant increases of wind power generation have been observed in Germany and in Spain. Stability of nuclear power generation results mainly from the commissioning of a new unit in Czech Republic and decommissioning of one unit in Germany.

Concerning the conventional thermal power stations, decommissioning decisions have been taken in various countries (Spain, France, Italy, Romania) while main developments concern combined cycles in Spain and Italy and lignite or coal fired plants in Greece and Poland.

Comments

- E** In conventional sources, 2000 MW of combined cycles have been installed, and approx. 1000 MW of wind power plants commissioned. In the mean time, approx. 700 MW of heavy oil plants have been shutdown.
- D** In February 2003 the first 265MW machine in the new pump-storage power station Goldistahl was commissioned. The commission of the second machine was in July; two further machines will be available in the year 2004. The total capacity of wind energy plants increased to more than 14 000MW. Decommissioning of the nuclear power plant Stade (625 MW) in November 2003.
- F** The year 2003 was marked by
- the connection to the power transmission network of two co-generation units in Haute Normandie region, and of three household waste incineration plants in Picardie, Haute Normandie and Languedoc-Roussillon regions representing a total capacity of 285.5 MW.
 - increase in capacity of the two units of the Chooz B nuclear power plant in the Ardennes (total increase of 90 MW).
 - approx. 500 MW of conventional thermal capacity has been mothballed.
- GR** The new conventional thermal power plant in Meliti-Achlada is a lignite power plant of an installed capacity of 330 MW. The new power plant was put into commercial operation in June 2003.
- I** Approx. 670 MW of thermal plants, and 160 MW of renewable sources power plants, have been commissioned.
- HR** In combined thermal power station TE-TO Zagreb new fossil oil/gas production units (3x70 MW) were put into operation. From April 19th, 2003 half of the production of nuclear power plant Krško is delivered once again to Croatian system, according to ownership contract. Croatian system is once again receiving energy from Bosnia and Herzegovina on the basis of joint venture construction of thermal power plants (maximal power 180 MW).
- L** Solar and wind power plants have been commissioned and contribute for approx. 21MW generating capacity.

- NL** 110 MW of thermal co-generators have been commissioned.
- P** While a 130 MW conventional thermal power plant (Alto Mira) has been shut down, 390 MW of combined cycle and 120 MW of hydro generator have been commissioned in 2003.
- CZ** A nuclear unit (950 MW) has been commissioned.
- H** Three conventional thermal plants have been commissioned, accounting for 40 MW.
- PL** 60 MW of hydro plants have been commissioned, and 430 MW of conventional thermal plants as well. Thermal power units have been shutdown, for an approx. capacity of 150 MW.
- SK** A wind power plants has been commissioned in Cerovo in October, amounting 2.4 MW.
- RO** Three units of conventional thermal power plants, accounting for 743 MW, have been shutdown for refurbishment.
- BI-UA** A conventional thermal plant (representing 6 MW) has been shutdown.

3.2 Unavailable capacity and reserves management

The generating capacity is not completely available. In the power balance, unavailable capacity is divided into the following:

- non-usable capacity,
- capacity which is not available in thermal power plants as a result of overhauls or outages,
- reserve capacity for network services.

3.2.1 Non-usable capacity

Non-usable capacity is the part of generating capacity which cannot be scheduled, for different reasons: a temporary shortage of primary energy sources (hydroelectric plants, wind farms), power plants with multiple functions, in which the generating capacity is reduced in favour of other functions (co-generation, irrigation, etc.), reserve power plants which are only scheduled under exceptional circumstances, unavailability due to cooling-water restrictions, etc..

Non-usable capacity for all UCTE countries reached its lowest value in January (84.8 GW) and its highest value in August (111.9 GW). These values represent a rate of between 15.1% and 19.7% of the total national generating capacity in January and August, respectively (560.6 GW in January and 566.5 GW in August). As compared to 2002, when looking at former perimeter, non-usable capacity showed a massive increase in June and July (approx. +22GW), and in May, June and September (approx. +17 GW). The increase during the summer period results from climatic conditions' impact on power plant's availability. This phenomena was particularly sensitive in France.

Comments

- D** The share of renewable energy sources in the installed generating capacity has again considerably increased in 2003. This increase also explains the high level in non-usable capacity.
- E** Hydro conditions have been better in 2003, and the production increased by 72%.
- F** Non usable capacity has been lower in January and February, and higher in June and July. This is partly due to differences in hydro and weather conditions.
- GR** The energy capability factor ranged from 0.5 in December to 1.83 in January 2003. The water reserves were sufficient during the year and the hydro production was high due to the favourable hydro conditions. In 2003 the favourable hydro conditions and the new power plant in Meliti-Achlada, that was put in operation in summer, resulted in using the internal production to meet the demand while the imported energy covered not only the peaks of load but alsotook place in lower demand periods according to the business plan of incumbent supplier.

- I** Very high temperatures and humidity, in the summer period, were recorded on June, with consequent increase of the demand. In that period, emergency procedures concerning a scheduled load shedding plan on “rotating basis”, due to a conditions of insufficient power plants generation, was adopted. The year has been marked by a lower hydro conditions, especially during the last semester. Starting from July was reached until November the historical minimum since a long period in the reservoir capacity consequent the poor rainfall. This reason has reduced the hydro production.
- SLO** Hydro conditions were below average in the months March to October, and above average conditions in January, November and December 2003. Most overhauls were finished between January and the end of February. Limitations due to the transmission network occurred, owing to congestion on the borders with Austria and Italy. Limitations for environmental reasons were applied in February to the Sostanj power plant.
- HR** Hydro conditions during the year 2003: very dry conditions during summer and low water power (4700 GWh in 2003 versus 5803 GWh in 2002). At the end of the year one 136 MW reversible generating unit of reversible HPP Velebit came out of service because of damage. There are no significant differences between operating conditions in year 2003 and year 2002.
- L** The hydro power is greatly influenced by the implementation of the pump storage plant of Vianden. Due to an exceptional low precipitation level, other hydro production was very low.
- NL** In July and August several power plants were affected in their maximum production possibilities by cooling-water restrictions, and this resulted in a lack of reserve-power. So in the first two weeks of August the “Code red” meaning “alert” was announced, but fortunately the system stayed out of situations where would have to be taken emergency measures.
- CZ** Extremely high value 3,7 GW in August was caused by planned maintenance in the transmission system, which terminated the possibility of the production in NPP Temelin.
- BiH** Lower hydro conditions have been observed.
- RO** The June - September period was much warmer than the yearly average, and the rain volume taken for the whole country was deficient, which affected particularly the generation in the run-on-the -river hydro power plants. The impact of difficult weather conditions on the system operation security was reduced due to available generation capacities in classical thermal power plants.

3.2.2 Thermal power plant overhauls

In the UCTE countries, non-available capacity due to overhauls reached a peak of 47.5 GW in May which represents 11.6% of the generating capacity of thermal power plants for that month. This value is lower than in the two previous years where the highest level of overhauls reached around 15%.

TABLE 5 shows the characteristic values of overhaul in the UCTE.

Comments

- B** This information are commercially sensible and giving them for Belgium means giving them for the main producer.
- E** During the summer, there were unusual weather conditions with consequent higher than typical demand values. Some generating units were unavailable because of maintenance works.
- GR** There is no significant difference between the performed and the scheduled overhauls.
- I** No sensible difference has been observed.
- SLO** The overhaul program has been similar to the one of 2002.

Table 5 | Characteristic values of overhaul programmes in the UCTE

Results in GW

| Country | Max.capacity thermal power stations December 2003 GW | Overhaul capacity, 3 rd Wednesday at 11:00 a.m. | | | | month |
|-------------|---|--|--|-------------|--|----------|
| | | Average value | | Max.value | | |
| | | GW | Percent of thermal capacity % | GW | Percent of thermal capacity % | |
| B | 14.0 | 0.9 | 6.3 | 1.7 | 12.4 | VII |
| D | 88.2 | 5.8 | 6.6 | 11.3 | 12.8 | VII |
| E | 35.6 | 1.0 | 2.9 | 2.5 | 7.0 | III |
| F | 86.6 | 8.3 | 9.6 | 13.0 | 15.0 | IX |
| GR | 7.1 | 0.5 | 6.4 | 0.8 | 11.3 | IV |
| I | 55.3 | 4.6 | 8.3 | 5.1 | 9.2 | II |
| SLO | 1.9 | 0.1 | 6.6 | 0.7 | 34.7 | V |
| HR | 2.0 | 0.0 | 1.3 | 0.2 | 10.2 | V |
| BiH | 1.8 | 0.3 | 16.3 | 0.9 | 50.3 | V |
| FYROM | 0.9 | 0.1 | 12.4 | 0.4 | 44.5 | VI |
| SCG | 6.4 | 1.7 | 26.4 | 2.8 | 43.8 | VI |
| L | 0.5 | 0.1 | 13.5 | 0.4 | 81.2 | VII |
| NL | 18.0 | 1.2 | 6.7 | 2.2 | 12.4 | X |
| A | 5.6 | n.a. | n.a. | n.a. | n.a. | n.a. |
| P | 5.7 | 0.2 | 3.4 | 0.6 | 11.0 | IX |
| CH | 3.8 | 0.4 | 10.7 | 2.7 | 71.1 | VIII |
| CZ | 14.1 | 1.5 | 10.8 | 3.0 | 21.3 | V |
| H | 7.3 | 0.5 | 7.3 | 0.8 | 10.8 | VI |
| PL | 29.3 | 2.6 | 8.9 | 5.0 | 16.9 | VI |
| SK | 4.9 | 0.6 | 12.2 | 1.1 | 22.3 | VII |
| RO | 10.4 | 1.2 | 11.3 | 1.6 | 15.4 | VIII |
| BG | 9.6 | 2.4 | 24.9 | 4.0 | 41.8 | VI |
| UCTE | 411.5 | 34.3 | 8.3 | 48.8 | 11.9 | V |
| BI-UA | 2.5 | 0.4 | 16.1 | 0.6 | 24.8 | VII |

HR Overhauls were somewhat rescheduled in accordance with hydrology conditions, consumption and capabilities of production units during the year.

L The scheduled overhaul time for the thermal power plant was 4 weeks, but finally took 6 weeks.

NL The scheduled overhauls are here below given, as TenneT isn't informed about performed overhauls:

- Volume of the overhaul schedule 2002 39239 MW/weeks
- Volume of the overhaul schedule 2003 63296 MW/weeks

A The TSO has no complete and detailed information about overhaul programs.

FYROM There is no difference between the performed and scheduled overhauls in 2003. Planned overhauls of the TPP last about 6 weeks, and the difference between overhauls in 2002 and 2003 is only in the starting date.

H Overhauls caused temporary shortage in June and July. It was covered by import.

RO The generation capacity in overhauls was greater than forecasted in the first months of the year and lower than forecasted in the summer period. The generation capacity in overhaul was lower than in 2002.

BI-UA Differences between the performed and the scheduled overhauls are caused by displacement in overhauls of units.

3.2.3 Thermal power plant outages

TABLES A/1 in the appendix show the non-available thermal capacity due to outages for each month of the year 2003. In 2003, the maximum value of not available capacity in the UCTE as a result of outages was 30.2 GW in August. This figure represents 7.4% of the nuclear and conventional thermal generating capacity for the same month. This figure was of 5 to 6% in the previous years.

Comments:

- B** This information are commercially sensible and giving them for Belgium means giving them for the main producer.
- E** Higher than usual outages were observed, due to sustained abnormally high temperature period. These operating conditions forced contractual supply interruptions to be applied.
- F** A particularly high level of outages has been observed from April to September, when compared to last year's values.
- GR** Since the forced outage is a random event, sometimes there are differences from the forecast.
- I** No sensible difference has been observed.
- SLO** Outage of the nuclear power plant Krsko (600 MW) occurred on August, 27th, and in the same time thermal power plant Sostanj (300 MW) was in outage.
- NL** As TenneT isn't informed about outages, an average estimation for outages of thermal power plants is given based on historical known values. For November and December this value is set higher for the reason that at the end of October occurred a fatal accident during the overhaul of the boiler of a 600 MW plant and the unit was put out of use until the end of the year.
- CZ** High values in May (1,2 GW) and in October (1,5 GW) were caused by outages of the 950 MW nuclear units in Temelin power station. As far as forecast are concerned, an "average" outage about 500 MW is taken into account.
- RO** The number of unit tripping was lower than forecasted and much lower than the number of tripping registered in 2002.

3.2.4 Reserve for system services

The reserve for system services is the estimated reserve capacity which is required for system operation. It is therefore the reserve capacity which is available to TSOs from power plant operators, and includes the following specific elements:

- The "second reserve" and the "minute reserve", which are made available to TSOs under the contractual terms of the network frequency control service, using the requisite technical facilities;
- "Other reserves", such as reserves for voltage control or the management of bottlenecks, which are managed by TSOs under the terms of contracts.

However, the reserve for system services does not include reserves for long-term outages, which are to be covered by power plant operators.

During 2003, the reserve for system services ranged from 26.3 GW in July (approximately 8.6% of the synchronous load) to 32.4 GW in December (approximately 9.4% of the synchronous load). This values are stable over the years because they result of the application of the UCTE rules.

Comments:

- D** The TSO's system services reserve shows a relatively constant value over the year (around 7% of the installed generating capacity).
- E** The system service reserve established by the operation market rules has been affected in some hours due to the quick changes in wind production, with a maximum 500 MW/hour decrease.

- GR** System services reserve are estimated. All the available generating capacity is kept as a reserve, according to the financial offers submitted by the generators, in order to use it for voltage and flow congestion.
- I** No sensible difference has been observed.
- NL** The given system services reserve is only a part of the total capacity for system services reserve. About 300 MW is available as sheddable load.
- PL** In the UCTE Retrospect report 2002 one part of the system services reserves was included in non-usable capacity and now this part is shown within system services reserves. In operating conditions no special differences in comparison with year 2002.
- BiH** Reserves have been lower, owing to lower hydro conditions.
- RO** The generation reserve was always maintained close to the forecasted value and proved to be sufficient to cover control necessities.
- BI-UA** Load shedding 45 MW agreed with distribution companies in case of reserve deficiency may be added to reserve.

3.2.5 Guaranteed capacity

Guaranteed capacity is obtained by deducting non-usable capacity, overhauls, outages and system reserve to cover outages above average conditions or abnormal load situations, from the national generating capacity. Guaranteed capacity represents the capacity which is available to power plant operators and electricity traders for meeting their clients' demand. It is to be noted that in UCTE's methodology and definitions, "guaranteed capacity" will be replaced next year by "capacity reliably available".

The guaranteed capacity in the UCTE reached a peak value of 414.2 GW in December – this figure represents 73% of the total generating capacity (569.1 GW in December). The lowest value of 353.0 GW was reached in August – this represents 62.3% of the total generating capacity (566.5 in August). These figures are quite similar to the ones observed in the previous years.

Taking into account new countries of the UCTE brings out a ratio guaranteed capacity / total generating capacity 1% higher than with former perimeter.

3.3 Load

The load at the reference point for the UCTE countries reached a maximum of 355.5 GW in February. This figure is 6.9 GW higher than the maximum reference load recorded in 2002 (January), when taking into account the same perimeter. The load values at 11:00 a.m. on every Wednesday are shown in the TABLE 6.1.

Maximum loads recorded in the various countries in 2003 (not at the same time) are shown in TABLE 6.2.

Table 6.1

Load in 2003

Net values at the reference time 11:00 a.m. every month

Results in GW

| Country | Jan. | Feb. | March | April | May | June | July | Aug. | Sept. | Oct. | Noc. | Dec. |
|-------------|--------------|--------------|--------------|--------------|--------------|--------------|--------------|--------------|--------------|--------------|--------------|--------------|
| B | 12.3 | 12.3 | 11.2 | 10.7 | 10.9 | 10.7 | 10.1 | 10.5 | 10.7 | 11.3 | 11.5 | 12.3 |
| D | 70.9 | 71.3 | 68.6 | 66.9 | 68.2 | 66.2 | 66.4 | 64.2 | 67.5 | 68.1 | 70.1 | 70.2 |
| E | 34.5 | 35.0 | 26.3 | 27.1 | 28.7 | 31.6 | 30.5 | 27.6 | 29.4 | 28.9 | 30.6 | 32.4 |
| F | 76.1 | 76.7 | 61.5 | 56.6 | 55.9 | 55.9 | 56.3 | 48.4 | 54.1 | 58.9 | 66.7 | 74.1 |
| GR | 6.6 | 7.5 | 6.7 | 6.0 | 6.8 | 7.8 | 8.3 | 7.9 | 6.3 | 6.3 | 6.3 | 7.5 |
| I | 49.3 | 49.9 | 46.9 | 45.7 | 45.5 | 50.6 | 51.8 | 37.1 | 45.7 | 46.5 | 47.7 | 48.9 |
| SLO | 1.8 | 1.8 | 1.7 | 1.5 | 1.6 | 1.7 | 1.7 | 1.6 | 1.6 | 1.7 | 1.7 | 1.9 |
| HR | 2.3 | 2.5 | 2.1 | 1.9 | 1.8 | 1.9 | 1.9 | 2.0 | 1.8 | 1.9 | 2.1 | 2.4 |
| BiH | 1.6 | 1.55 | 1.4 | 1.2 | 1.2 | 1.1 | 1.1 | 1.2 | 1.2 | 1.3 | 1.4 | 1.5 |
| FYROM | 1.1 | 1.2 | 1.0 | 0.8 | 0.7 | 0.8 | 0.8 | 0.8 | 0.8 | 0.9 | 1.0 | 1.2 |
| SCG | 6.3 | 6.7 | 5.5 | 4.8 | 4.0 | 4.0 | 4.0 | 4.0 | 4.1 | 5.0 | 5.2 | 6.3 |
| L | 0.9 | 0.7 | 0.7 | 0.8 | 0.7 | 0.8 | 0.8 | 0.7 | 0.7 | 0.9 | 0.8 | 0.9 |
| NL | 13.8 | 13.2 | 12.7 | 12.8 | 12.3 | 12.7 | 12.5 | 12.8 | 13.0 | 12.4 | 13.6 | 13.9 |
| A | 8.3 | 8.4 | 7.6 | 7.3 | 7.2 | 7.4 | 7.1 | 7.1 | 6.9 | 7.4 | 8.0 | 8.5 |
| P | 7.1 | 6.8 | 5.8 | 5.7 | 5.8 | 6.1 | 5.8 | 5.0 | 6.0 | 5.8 | 6.0 | 6.7 |
| CH | 9.2 | 9.5 | 8.3 | 8.2 | 8.3 | 8.2 | 7.8 | 8.0 | 8.1 | 8.3 | 8.8 | 9.0 |
| CZ | 9.2 | 9.4 | 7.9 | 7.6 | 7.2 | 7.1 | 7.1 | 7.0 | 7.1 | 7.9 | 8.5 | 8.9 |
| H | 5.4 | 5.5 | 5.1 | 4.9 | 4.9 | 5.1 | 5.1 | 4.0 | 5.0 | 5.1 | 5.2 | 5.3 |
| PL | 18.7 | 18.8 | 16.9 | 16.1 | 15.5 | 14.7 | 14.9 | 15.2 | 15.5 | 17.2 | 18.1 | 18.6 |
| SK | 4.2 | 4.2 | 3.8 | 3.5 | 3.2 | 3.1 | 3.2 | 3.1 | 3.4 | 3.8 | 4.0 | 4.2 |
| RO | 7.0 | 7.1 | 6.8 | 5.9 | 5.8 | 6.0 | 5.8 | 5.7 | 5.5 | 6.3 | 6.7 | 7.0 |
| BG | 6.1 | 4.6 | 4.55 | 3.99 | 3.3 | 3.5 | 3.6 | 3.5 | 3.6 | 4.11 | 4.11 | 5.7 |
| UCTE | 353.7 | 355.5 | 313.5 | 300.7 | 300.0 | 307.4 | 307.0 | 277.7 | 298.5 | 310.5 | 328.8 | 348.2 |
| BI-UA | 0.8 | 0.8 | 0.7 | 0.6 | 0.4 | 0.5 | 0.5 | 0.5 | 0.5 | 0.6 | 0.7 | 0.7 |

Table 6.2

Time of maximum load in the various UCTE countries in 2003

| Country | Day | Date | Time maximum | Peak load | Difference from 2002 peak load | Observed T | Deviation from average T | Historical peak load |
|-----------------|-----------|----------|--------------|-----------|--------------------------------|------------|--------------------------|----------------------|
| | | | | MW | % | °C | °C | MW |
| B | Thursday | 09/01/03 | 18:00 | 13573 | - 0.9 | - 6.6 | - 10.5 | 13692 |
| D | Wednesday | 03/12/03 | 17:45 | 76300 | - 4.2 | 4.2 | 2.2 | 79700 |
| E | Thursday | 18/02/03 | 20:00 | 37212 | 8.5 | 2.8 | - 10.7 | 37212 |
| F | Wednesday | 08/01/03 | 19:00 | 80190 | 4.7 | - 2.6 | - 7.4 | 801190 |
| GR | Friday | 18/07/03 | 13:00 | 9042 | 1.3 | 32.0 | - 3.0 | 9042 |
| I | Wednesday | 10/12/03 | 17:00 | 53403 | 1.5 | 7.3 | - 1.0 | 53403 |
| SLO | Thursday | 11/12/03 | 18:00 | 1923 | 1.2 | - 3.0 | - 5.0 | 1923 |
| HR | Wednesday | 24/12/03 | 18:00 | 2673 | - 0.5 | - 0.7 | - 4.1 | 2796 |
| BiH | n.a. | n.a. | n.a. | 1854 | 5.3 | - 10.0 | 3.0 | n.a. |
| FYROM | Sunday | 28/12/03 | 18:00 | 1417 | 7.4 | - 5.5 | n.a. | 1417 |
| SCG | Monday | 13/01/03 | 18:00 | 7238 | 3.2 | - 10.4 | n.a. | 7799 |
| L | Wednesday | 12/03/03 | 12:00 | 959 | - 0.8 | 6.8 | - 0.7 | 966.5 |
| NL | Monday | 08/12/03 | 18:30 | 14469 | - 3.8 | - 2.0 | - 6.0 | 15046 |
| A | Monday | 13/01/03 | 17:45 | 8694 | 10.0 | - 8.0 | - 6.0 | 8694 |
| P | Wednesday | 15/01/03 | 20:45 | 8046 | 8.8 | 5.7 | - 4.1 | 8046 |
| CH | Wednesday | 19/02/03 | 11:45 | 9592 | n.a. | n.a. | n.a. | n.a. |
| CZ | Thursday | 09/01/03 | 17:00 | 10270 | - 0.4 | - 11.5 | - 11.7 | 10309 |
| H | Thursday | 11/12/03 | 17:00 | 5808 | 5.0 | 0.2 | - 0.6 | 6060 |
| PL | Wednesday | 08/01/03 | 17:00 | 21380 | 0.3 | - 14.5 | - 11.8 | 24685* |
| SK | Thursday | 09/01/03 | 19:00 | 4338 | - 1.9 | - 7.5 | - 6.1 | 4471 |
| RO | Wednesday | 17/12/03 | 17:00 | 7542 | - 1.3 | - 1.0 | - 2.0 | 10248 |
| BG ⁴ | n.a. | n.a. | n.a. | n.a. | n.a. | n.a. | n.a. | n.a. |
| BI-UA | Monday | 13/01/03 | 17:00 | 986 | 3.0 | - 7.2 | - 4.0 | 1018 |

* gross value

⁴for Bulgarian data not available, peak load has been considered as maximum of monthly reference load value

In 2003, the simultaneity factor (the common reference load of December divided by the sum of the individual peak loads) in the UCTE countries was 90.9%⁴ (as against 92.4% in 2002, 93.7% in 2001, 91.5% in 2000, 90.8% in 1999, 91.2% in 1998 and 93.6% in 1997) (with the 2002 perimeter, the simultaneity factor for 2003 is unchanged). This ratio gives an estimation by excess of the difference between reference load and synchronous peak load at UCTE level.

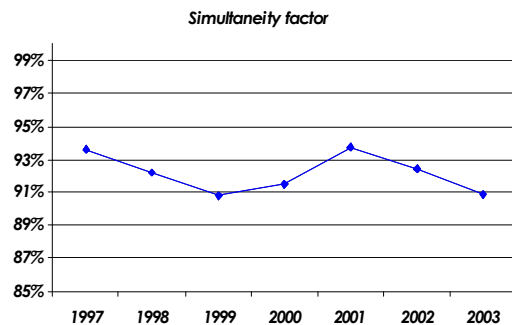

Yearly peak loads were observed in nine countries between the 8th and 15th of January. Six countries met their historical peak load in 2003, generally owing to the cold spells which occurred in January, February or December.

Comments:

- D** The temperatures observed during the day of the peak load and during the whole month have been considerably higher as compared with the previous year. This may be the reason for this decrease.
- E** In 2003, peak load has increased by 8.5% due to temperature factor (in 2002, the daily mean temperature the day of the peak load was 9°C, versus 2.8°C in 2003).
- F** The historical peak load was reached in 2003 during the cold spell at the beginning of the year.
- GR** The peak load presented a slight increase of 1.3% due to lower than expected ambient temperature in the peak month of July.
- I** 53.403 MW represents the maximum historical value for Italy.
- SLO** Peak load observed in 2003 (1923 MW) is the new historic peak load.
- NL** The given figures are the load as observed by TenneT. The total load of the Netherlands is supposed to be about 15% higher. The peak load of 2003 is nearby 4% lower than the peak load of 2002 due to better climatic conditions on that day. The average day temperature was 5 0C higher than last year and the sky was unclouded.
- P** The new historic peak load recorded in 2003 occurred due to a period of extremely low temperatures exceeding in 8% (580MW), the previous maximum which occurred in 2001.
- SK** The peak load was expected in December, when the week maximum was also expected. But at that time the weather was far warmer than expected (-0.5°C in average, as compared to -7°C in 2002).
- RO** The annual peak load was practically the same as last year.
- FY** The temperature has been very low, and a lot of households in Macedonia use electricity for heating.
- ROM**

3.4 Remaining capacity without exchanges

This value is obtained by deducting the reference load from the guaranteed capacity, and corresponds to the surplus of capacity, available to power plant operators. However, this should not be classified as an over-capacity. In practice, power plant operators need to have reserve capacity available in addition to the capacity for system service reserve. This capacity is required by power station operators to guarantee the reliability of supply to their clients, and compensate, for instance, longer power plant failures.

In fact, it is interesting to compare this capacity with both generating capacity and margin against monthly peak load (differences between synchronous peak load and sum of non synchronous peak loads). Remaining capacity can be interpreted as the capacity that the system needs to assure 5% of installed capacity availability - a margin of 5% is considered by many operators as the level necessary by suppliers to guarantee the reliability of supply to their clients, and compensate, for instance, longer power plant failures - and, at the same time, the capacity necessary to cover the "margin against monthly peak load⁵".

Monthly values for the remaining capacity without exchanges in proportion to total generating capacity in all countries are shown in TABLE 7.

| Month | Jan. | Feb. | March | April | May | June | July | Aug. | Sept. | Oct. | Nov. | Dec. |
|--------------------|------|------|-------|-------|------|------|------|------|-------|------|------|------|
| UCTE 2003** | 10.7 | 9.8 | 12.7 | 12.6 | 11.0 | 9.7 | 9.5 | 13.3 | 12.1 | 12.8 | 12.4 | 11.6 |
| UCTE 2003* | 10.4 | 9.0 | 12.1 | 12.1 | 10.5 | 9.1 | 8.8 | 12.8 | 11.5 | 12.3 | 11.9 | 11.1 |
| UCTE 2002* | 9.7 | 11.3 | 12.9 | 11.6 | 13.4 | 9.0 | 11.6 | 11.1 | 10.9 | 11.3 | 12.5 | 11.3 |
| UCTE 2001* | 11.9 | 12.4 | 12.4 | 11.6 | 11.7 | 12.0 | 13.0 | 17.5 | 11.9 | 13.5 | 10.9 | 8.4 |

* excluding BiH, RO, BG and BI-UA
** included BiH, RO, BG and BI-UA

The lowest values are observed in February, June and July (9.7%), more than 2 GW lower than in 2002 (for February and July). The ratio observed in July is lowest encountered in the UCTE since December 2001.

Values in January, August, September and October are higher than in 2002.

⁵ The margin against the peak load represents the difference between the reference load and the peak load.

The following Tables 7.1 and 7.2 give the detail of the remaining capacity values for the UCTE countries for every month in 2003: values are given in GW and as % of the Generating Capacity respectively.

| Country | Jan. | Feb. | March | April | May | June | July | Aug. | Sept. | Oct. | Nov. | Dec. |
|-------------|-------------|-------------|-------------|-------------|-------------|-------------|-------------|-------------|-------------|-------------|-------------|-------------|
| B | 0.4 | 0.4 | 0.4 | 1.4 | 1.2 | 1.3 | 1.2 | 1.9 | 1.3 | 0.8 | 0.7 | 0.4 |
| D | 9.7 | 9.0 | 10.6 | 8.7 | 5.5 | 5.7 | 3.2 | 9.4 | 9.2 | 11.0 | 11.7 | 10.5 |
| E | 6.6 | 6.0 | 12.0 | 11.1 | 9.0 | 7.4 | 9.6 | 10.4 | 9.9 | 11.9 | 11.8 | 11.3 |
| F | 7.3 | 4.5 | 9.8 | 11.6 | 7.1 | 7.0 | 3.8 | 11.0 | 8.5 | 8.6 | 10.1 | 8.2 |
| GR | 1.5 | 0.4 | 0.9 | 1.2 | 0.7 | 0.7 | 0.8 | 0.8 | 1.7 | 1.7 | 1.5 | 0.5 |
| I | 2.3 | 1.7 | 1.9 | 3.2 | 4.4 | 0.1 | - 1.7 | 8.9 | 2.9 | 4.1 | 0.4 | 1.6 |
| SLO | 0.2 | 0.3 | 0.3 | 0.5 | 0.0 | 0.5 | 0.4 | 0.3 | 0.5 | 0.5 | 0.6 | 0.4 |
| HR | 1.2 | 1.0 | 1.3 | 1.7 | 1.6 | 1.7 | 1.7 | 1.6 | 1.7 | 1.6 | 1.4 | 1.1 |
| BIH | 1.8 | 1.9 | 1.8 | 1.4 | 0.9 | 1.4 | 1.7 | 1.5 | 1.4 | 1.9 | 1.8 | 1.6 |
| FYROM | 0.0 | 0.0 | 0.1 | 0.2 | 0.1 | 0.0 | 0.2 | 0.2 | 0.3 | 0.2 | 0.2 | 0.0 |
| SCG | - 1.1 | - 0.7 | - 0.3 | - 0.1 | 0.1 | - 0.1 | - 0.3 | - 0.5 | - 0.5 | - 0.3 | - 0.8 | - 1.0 |
| L | 0.8 | 0.9 | 0.5 | 0.8 | 0.9 | 0.8 | 0.4 | 0.6 | 0.9 | 0.8 | 0.9 | 0.8 |
| NL | 3.2 | 3.6 | 3.7 | 2.7 | 3.4 | 2.8 | 3.9 | 3.2 | 2.8 | 2.8 | 2.5 | 2.5 |
| A | 5.1 | 5.1 | 5.4 | 3.8 | 3.8 | 4.4 | 5.4 | 4.9 | 5.1 | 5.8 | 4.2 | 4.4 |
| P | 0.7 | 1.6 | 2.3 | 2.2 | 2.1 | 1.6 | 1.8 | 1.7 | 1.1 | 2.0 | 2.4 | 1.8 |
| CH | 4.7 | 4.0 | 3.9 | 4.2 | 4.9 | 3.6 | 5.1 | 3.7 | 5.4 | 4.7 | 4.8 | 5.4 |
| CZ | 2.4 | 1.3 | 2.2 | 2.4 | 2.5 | 3.2 | 3.6 | 1.6 | 3.2 | 2.0 | 3.1 | 3.4 |
| H | 0.4 | 0.3 | 0.7 | 0.3 | 0.2 | - 0.1 | - 0.2 | 0.8 | 0.2 | 0.2 | 0.3 | 0.3 |
| PL | 7.7 | 6.9 | 7.2 | 6.8 | 6.5 | 6.4 | 7.3 | 6.9 | 6.7 | 6.6 | 6.8 | 7.0 |
| SK | 1.4 | 1.4 | 0.8 | 0.9 | 1.5 | 1.1 | 0.6 | 0.7 | 0.4 | 0.7 | 1.1 | 0.9 |
| RO | 1.3 | 2.1 | 2.8 | 2.9 | 2.6 | 2.6 | 2.5 | 1.9 | 2.3 | 2.0 | 1.9 | 2.2 |
| BG | 2.1 | 3.0 | 2.6 | 2.3 | 2.6 | 2.2 | 2.5 | 3.2 | 3.1 | 2.6 | 2.9 | 2.3 |
| UCTE | 60.2 | 55.1 | 71.5 | 70.7 | 62.0 | 54.9 | 53.8 | 75.3 | 68.7 | 72.7 | 70.5 | 66.0 |
| BI-UA | 0.4 | 0.5 | 0.4 | 0.4 | 0.5 | 0.4 | 0.4 | 0.5 | 0.5 | 0.5 | 0.4 | 0.5 |

Table 7.2

**Remaining capacity without exchanges 2003
as a % of the generating capacity at the reference point**

Results in %

| Country | Jan. | Feb. | March | April | May | June | July | Aug. | Sept. | Oct. | Nov. | Dec. |
|-------------|-------------|------------|-------------|-------------|-------------|------------|------------|-------------|-------------|-------------|-------------|-------------|
| B | 2.6 | 2.6 | 2.4 | 9.2 | 7.9 | 8.6 | 7.5 | 12.2 | 8.6 | 5.4 | 4.7 | 2.6 |
| D | 8.9 | 8.2 | 9.7 | 7.9 | 5.0 | 5.2 | 2.9 | 8.5 | 8.3 | 9.9 | 10.6 | 9.4 |
| E | 11.6 | 10.4 | 20.9 | 19.2 | 15.5 | 12.6 | 16.3 | 17.6 | 16.6 | 20.0 | 19.8 | 18.9 |
| F | 6.6 | 4.1 | 8.9 | 10.4 | 6.4 | 6.3 | 3.4 | 9.9 | 7.7 | 7.7 | 9.1 | 7.4 |
| GR | 15.4 | 3.9 | 9.1 | 12.0 | 7.5 | 6.8 | 8.1 | 7.8 | 16.0 | 16.2 | 14.7 | 4.8 |
| I | 3.0 | 2.2 | 2.5 | 4.2 | 5.7 | 0.1 | - 2.2 | 11.5 | 3.8 | 5.3 | 0.5 | 2.1 |
| SLO | 6.0 | 9.6 | 12.4 | 18.1 | - 1.0 | 19.2 | 12.9 | 11.7 | 17.9 | 18.8 | 23.0 | 15.9 |
| HR | 29.3 | 24.4 | 31.7 | 41.5 | 39.0 | 41.5 | 41.5 | 39.0 | 41.5 | 39.0 | 34.1 | 26.8 |
| BiH | 47.4 | 50.0 | 47.4 | 36.8 | 23.7 | 36.8 | 44.7 | 39.5 | 36.8 | 50.0 | 47.4 | 42.1 |
| FYROM | 0.5 | - 2.7 | 7.7 | 15.6 | 6.6 | - 3.0 | 12.0 | 13.4 | 20.2 | 18.0 | 11.8 | - 3.4 |
| SCG | - 11.1 | - 7.1 | - 3.0 | - 1.0 | 1.0 | - 1.0 | - 3.0 | - 5.1 | - 5.1 | - 3.0 | - 8.1 | - 10.1 |
| L | 46.5 | 53.9 | 33.0 | 50.5 | 54.3 | 52.3 | 26.0 | 35.7 | 55.4 | 47.7 | 51.9 | 48.2 |
| NL | 16.1 | 18.2 | 18.5 | 13.5 | 17.0 | 14.3 | 19.4 | 16.3 | 14.3 | 14.2 | 12.3 | 12.4 |
| A | 30.2 | 30.0 | 31.6 | 22.6 | 22.4 | 25.8 | 31.6 | 28.5 | 30.2 | 33.8 | 24.5 | 25.5 |
| P | 7.2 | 16.0 | 23.1 | 21.7 | 20.8 | 15.8 | 17.8 | 16.8 | 10.4 | 19.3 | 22.4 | 16.8 |
| CH | 27.0 | 23.0 | 22.8 | 24.0 | 28.2 | 20.9 | 29.5 | 21.5 | 31.3 | 26.9 | 27.6 | 31.3 |
| CZ | 15.8 | 8.6 | 14.5 | 15.8 | 15.5 | 19.9 | 22.4 | 9.9 | 19.9 | 12.4 | 19.3 | 21.1 |
| H* | 4.7 | 3.9 | 9.3 | 4.1 | 2.4 | - 1.8 | - 3.0 | 10.2 | 2.5 | 2.2 | 3.2 | 3.4 |
| PL | 24.7 | 22.0 | 22.9 | 21.8 | 20.7 | 20.5 | 23.4 | 22.2 | 21.3 | 21.0 | 21.5 | 22.0 |
| SK | 17.5 | 17.5 | 10.0 | 11.3 | 18.8 | 13.8 | 7.5 | 8.8 | 5.0 | 8.8 | 13.8 | 11.3 |
| RO | 8.1 | 12.7 | 17.1 | 17.4 | 15.6 | 16.1 | 15.0 | 11.8 | 14.2 | 12.4 | 11.6 | 13.7 |
| BG | 17.1 | 24.0 | 21.0 | 18.8 | 21.0 | 17.6 | 20.7 | 26.3 | 25.4 | 21.1 | 23.3 | 18.7 |
| UCTE | 10.7 | 9.8 | 12.7 | 12.6 | 11.0 | 9.7 | 9.5 | 13.3 | 12.1 | 12.8 | 12.4 | 11.6 |
| BI-UA | 17.6 | 19.9 | 16.7 | 15.0 | 18.0 | 14.6 | 16.1 | 18.2 | 18.0 | 18.9 | 17.6 | 18.2 |

These values, together with the margin against peak load, expressed as a proportion of the monthly peak load, are shown in Figure 3. This margin provides an estimate of the potential fluctuations in demand which the remaining capacity would be required to cover.

Figure 3

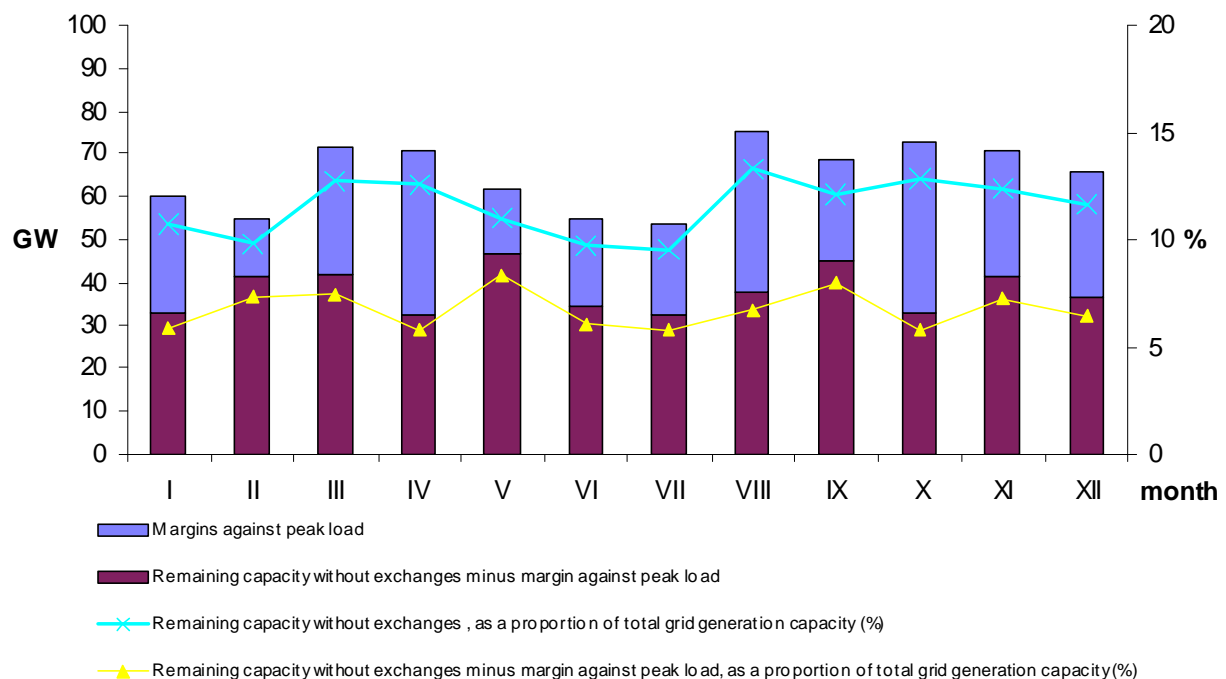
Remaining capacity

The remaining capacity observed at the monthly reference points was sufficient to meet the reference adequacy margin for the whole UCTE level (i.e. provide a 5% generation reserve while at the same time covering the peak load).

The remaining capacity minus margin against peak load, as a proportion of total generation capacity, has reached its lowest level in October (with 5.5%). When looking at the situation of individual countries, it can be noticed that remaining capacity without exchanges has met negative values all year for Serbia and Montenegro, Hungary in June and July, and Italy in July. At these periods the supply of these countries partly relied on imports. When considered as a proportion of national generation capacity, values lower than 5% have been met for Belgium in winter, Germany in July, France in February and July, Greece in February, June and August, Italy most of the year, Hungary all year except in March and August, Slovenia in May, Macedonia in January, February, June and December.

The following information from individual UCTE countries are relevant to the interpretation of the remaining capacity:

Comments

- D** During most of the months, the remaining capacity without exchanges totalled more than 5% of the generating capacity. Only in July was it slightly below this value. The remaining capacity without exchanges for the Retrospect 2003 is higher than expected in the forecasts of January 2003, due to the fact that the real load has been lower than expected. The remaining capacity without exchanges in July 2003 is equal to the forecasted figure.
- E** The remaining capacity has increased, due to the newly commissioned capacities (2000 MW in combined cycles, and 1000 MW of wind units), and to the fact that the year has been very wet.
- GR** If the margin against the peak load is taken into account, the remaining capacity without exchanges consisted mostly of hydro capacity which is available on short term.
- NL** The given remaining capacity is of limited significance, due to the fact that values of exact outages are not available, and as the load of the monthly statistics represents about 85% of the total load of the Netherlands.
- RO** The remaining capacity was over 1300 MW , that is over 15.6% of the guaranteed capacity .

FIGURE 4 shows correlation between spot market prices at Pownernext and EEX, and remaining capacity without exchanges, for reference monthly hours. It clearly shows that the periods of lowest level of remaining capacity effectively corresponds to relatively high markets prices.

Figure 4 | **Market prices - Remaining capacity without exchanges**

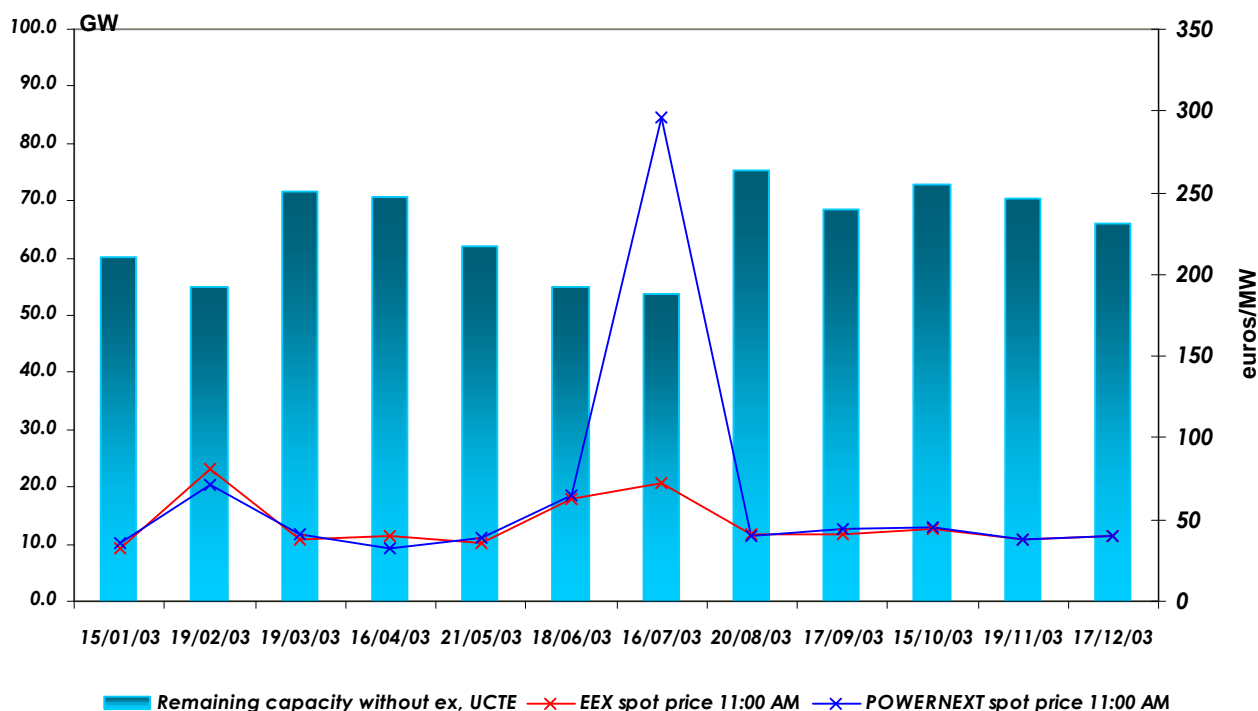

3.5 Balance of physical exchanges

The balance of physical exchanges represents the net exchange in the UCTE as a whole. It is generally an import-orientated balance, except in March and April. The maximum value recorded is 6.9 GW import in June, which represents 2.2% of the load (307.4 GW in June).

The following Table 7.3 gives the detail of the balance of the exchanges values for the UCTE countries for every month in 2003:

| Table 7.3 | Balance of physical exchanges 2003 (negative values corresponds to export) Net values at the reference time - 11:00 a.m. every month | | | | | | | | | | | |
|-------------|--|------------|--------------|--------------|------------|------------|------------|------------|------------|------------|------------|------------|
| | Results in GW | | | | | | | | | | | |
| Country | Jan. | Feb. | March | April | May | June | July | Aug. | Sept. | Oct. | Nov. | Dec. |
| B | 1.6 | 1.8 | 1.6 | 1.0 | 1.6 | 0.8 | 0.3 | 0.2 | 0.9 | 1.0 | 1.8 | 0.6 |
| D | 1.6 | 1.6 | 2.9 | 3.4 | 5.8 | 5.8 | 1.9 | 4.4 | 2.7 | 1.6 | 3.6 | 2.8 |
| E | 1.1 | 0.7 | 0.1 | - 0.9 | - 0.8 | - 0.1 | - 0.3 | 0.1 | 0.0 | 0.6 | - 0.2 | - 0.8 |
| F | - 6.4 | - 4.4 | - 8.9 | - 8.6 | - 5.9 | - 4.6 | - 2.4 | - 5.0 | - 5.1 | - 4.7 | - 8.8 | - 7.3 |
| GR | 0.3 | 0.4 | 0.5 | 0.4 | 0.2 | 0.5 | 0.5 | 0.6 | 0.1 | 0.3 | 0.2 | 0.5 |
| I | 6.1 | 6.0 | 6.0 | 6.8 | 5.8 | 5.5 | 5.7 | 3.3 | 5.9 | 6.4 | 6.3 | 5.9 |
| SLO | 0.0 | 0.0 | - 0.2 | - 0.1 | 0.5 | 0.0 | 0.0 | 0.4 | 0.0 | 0.0 | 0.1 | 0.0 |
| HR | 0.3 | - 0.1 | 0.5 | 0.4 | 0.4 | 0.6 | 0.4 | 0.7 | 0.5 | 0.6 | 0.5 | 0.5 |
| BIH | - 0.3 | 0.1 | - 0.3 | - 0.3 | - 0.1 | 0.0 | - 0.1 | 0.1 | - 0.2 | 0.1 | - 0.4 | - 0.3 |
| FYROM | 0.2 | 0.2 | 0.1 | 0.0 | 0.1 | 0.2 | 0.1 | 0.1 | 0.1 | 0.1 | 0.1 | 0.3 |
| SCG | 1.1 | 0.7 | 0.3 | 0.1 | - 0.1 | 0.1 | 0.3 | 0.5 | 0.5 | 0.3 | 0.8 | 1.0 |
| L | 0.2 | 0.3 | 0.7 | 0.1 | 0.1 | 0.2 | 0.4 | 0.2 | 0.2 | - 0.1 | 0.2 | 0.4 |
| NL | 2.4 | 1.3 | 2.3 | 2.9 | 2.5 | 2.6 | 1.5 | 3.0 | 2.3 | 3.0 | 2.6 | 3.1 |
| A | 0.5 | 0.3 | 0.1 | - 0.4 | 0.2 | 1.5 | 0.7 | 0.4 | 0.8 | 0.9 | - 1.2 | - 0.9 |
| P | 0.0 | 0.1 | - 0.4 | - 0.3 | 0.2 | 0.2 | 0.1 | 0.2 | 0.2 | 0.9 | - 1.2 | - 0.9 |
| CH | - 1.7 | - 2.3 | - 1.1 | - 1.7 | - 1.7 | - 2.7 | - 3.8 | - 1.3 | - 1.9 | - 2.0 | 0.8 | - 0.1 |
| CZ | - 1.3 | - 0.8 | - 1.3 | - 1.4 | - 1.9 | - 1.8 | - 2.0 | - 1.1 | - 1.7 | - 1.2 | - 1.9 | - 1.7 |
| H | 0.4 | 0.8 | 0.7 | 0.8 | 1.0 | 1.0 | 1.0 | 0.8 | 1.2 | 1.2 | 1.2 | 1.1 |
| PL | - 2.2 | - 2.2 | - 2.2 | - 2.1 | - 1.5 | - 1.4 | - 1.7 | - 1.9 | - 2.2 | - 1.9 | - 2.1 | - 1.9 |
| SK | - 0.4 | - 0.5 | - 0.1 | - 0.1 | - 0.5 | - 0.3 | 0.1 | - 0.3 | - 0.1 | 0.0 | - 0.2 | - 0.1 |
| RO | - 0.5 | - 0.4 | - 0.4 | - 0.4 | - 0.5 | - 0.4 | - 0.3 | - 0.4 | 0.0 | - 0.1 | - 0.4 | - 0.4 |
| BG | - 0.8 | - 0.6 | - 0.7 | - 0.5 | - 0.2 | - 0.4 | - 0.8 | - 0.9 | - 1.1 | - 0.7 | - 0.9 | - 0.9 |
| UCTE | 2.1 | 2.8 | - 0.2 | - 1.3 | 4.6 | 6.9 | 1.4 | 3.7 | 2.6 | 5.2 | 2.1 | 1.6 |
| BI-UA | - 0.4 | - 0.4 | - 0.4 | - 0.4 | - 0.5 | - 0.4 | - 0.4 | - 0.4 | - 0.5 | - 0.5 | - 0.5 | - 0.4 |

Comments

- D** The trend of the past years towards increased import at peak load has continued.
- F** As far as France is concerned, it should be noticed that the instantaneous balance of exchanges remained largely export-orientated throughout the whole of 2003, including during maximum consumption periods. Nevertheless, when compared to last year, the export-oriented balance is lower in 2003 for every month. In particular in May, June, July and December, the difference to 2002 reaches 4 GW.
- GR** There was a decrease in imported electrical energy in comparison to 2002 due to the favourable hydro conditions and to the new power plant of Meliti-Achlada.
- I** During the 2003 was recorded a very small increase in the exchanges balance as regards to 2002. The import in the Italian western border has signed a sensible reduction since October, caused by a revision in the exporting scheduled energy after the black-out that occurred on September the 28th.
- SLO** Changes have been observed in the physical exchanges, with values varying from – 450 MW to +290 MW. The delivery to Croatia of nuclear power plant Krsko' energy, that had been interrupted the former years is one reason of this evolution.
- HR** Import of energy was higher because of consumption increase and lower production of HPPs. Imports also include deliveries of energy from NPP Krško and from joint venture TPPs in Bosnia and Herzegovina (on the basis of long term contract with EP-BIH Sarajevo). Transits of energy were about 5 times larger than in 2002. This was mainly caused by dry conditions across Europe resulting in increased needs of customers in Bosnia and Herzegovina and Slovenia. Energy is transited mostly from Hungary to Bosnia and Herzegovina and from Hungary to Slovenia.

- P** The liberalisation of electricity market brought new agents to the market and has incremented exchanges.
- PL** Last year we noticed an increase in exchanges in export.
- RO** Physical exchanges were lower than in the last year and with a more uniform monthly distribution.
- BI-UA** In Line "Exchange" of energy balance for whole year and every month energy transmitted through transmission line 35 kV Uzgorod-Sobranci is not included. Total energy for 2003 transmitted from Ukraine to Slovakia through this line is 52 GWh.

3.6 Remaining capacity with exchanges

For the UCTE, the remaining capacity including exchanges ranges from 55.2 GW in July to 79.0 GW in August. The following Tables 7.4 gives the detail of the remaining capacity with exchanges for the UCTE countries for every month in 2003 : values are given in GW.

| Table 7.4 | Remaining capacity with exchanges 2003 | | | | | | | | | | | Results in GW |
|-------------|---|-------------|-------------|-------------|-------------|-------------|-------------|-------------|-------------|-------------|-------------|---------------|
| | Net values at the reference time 11:00 a.m. every month | | | | | | | | | | | |
| Country | Jan. | Feb. | March | April | May | June | July | Aug. | Sept. | Oct. | Nov. | Dec. |
| B | 2.0 | 2.2 | 2.2 | 2.4 | 2.8 | 2.1 | 1.5 | 2.1 | 2.2 | 1.8 | 2.5 | 1.0 |
| D | 11.3 | 10.6 | 13.5 | 12.1 | 11.3 | 11.5 | 5.1 | 13.8 | 11.9 | 12.6 | 15.3 | 13.3 |
| E | 7.7 | 6.6 | 12.1 | 10.3 | 8.2 | 7.4 | 9.3 | 10.6 | 9.9 | 12.5 | 11.6 | 10.5 |
| F | 0.9 | 0.1 | 0.9 | 3.0 | 1.2 | 2.4 | 1.4 | 6.0 | 3.4 | 3.9 | 1.3 | 0.9 |
| GR | 1.9 | 0.8 | 1.4 | 1.6 | 1.0 | 1.2 | 1.4 | 1.4 | 1.7 | 2.0 | 1.7 | 1.0 |
| I | 8.4 | 7.7 | 7.9 | 10.0 | 10.2 | 5.6 | 4.0 | 12.2 | 8.8 | 10.5 | 6.7 | 7.5 |
| SLO | 0.2 | 0.3 | 0.1 | 0.4 | 0.5 | 0.5 | 0.4 | 0.7 | 0.5 | 0.5 | 0.8 | 0.5 |
| HR | 1.5 | 0.9 | 1.8 | 2.1 | 2.0 | 2.3 | 2.1 | 2.3 | 2.2 | 2.2 | 1.9 | 1.6 |
| BiH | 1.5 | 2.0 | 1.5 | 1.1 | 0.8 | 1.4 | 1.6 | 1.6 | 1.2 | 2.0 | 1.4 | 1.3 |
| FYROM | 0.2 | 0.1 | 0.2 | 0.2 | 0.2 | 0.2 | 0.3 | 0.3 | 0.4 | 0.3 | 0.3 | 0.2 |
| SCG | 0.0 | 0.0 | 0.0 | 0.0 | 0.0 | 0.0 | 0.0 | 0.0 | 0.0 | 0.0 | 0.0 | 0.0 |
| L | 0.9 | 1.2 | 1.2 | 0.9 | 0.9 | 1.0 | 0.8 | 0.8 | 1.1 | 0.7 | 1.1 | 1.2 |
| NL | 5.6 | 4.9 | 6.0 | 5.5 | 5.9 | 5.4 | 5.4 | 6.2 | 5.1 | 5.9 | 5.0 | 5.6 |
| A | 5.6 | 5.4 | 5.5 | 3.4 | 4.0 | 5.9 | 6.1 | 5.2 | 5.9 | 6.7 | 3.0 | 3.5 |
| P | 0.7 | 1.7 | 2.0 | 1.9 | 2.3 | 1.8 | 1.9 | 1.9 | 1.3 | 2.3 | 2.8 | 2.0 |
| CH | 3.0 | 1.7 | 2.8 | 2.5 | 3.2 | 0.9 | 1.4 | 2.4 | 3.5 | 2.6 | 5.5 | 5.3 |
| CZ | 1.1 | 0.5 | 0.9 | 1.0 | 0.6 | 1.4 | 1.6 | 0.5 | 1.5 | 0.8 | 1.2 | 1.7 |
| H* | 0.8 | 1.1 | 1.5 | 1.1 | 1.2 | 0.9 | 0.7 | 1.6 | 1.4 | 1.3 | 1.5 | 1.4 |
| PL | 5.5 | 4.7 | 5.0 | 4.8 | 5.0 | 5.1 | 5.7 | 5.0 | 4.5 | 4.7 | 4.7 | 5.1 |
| SK | 1.0 | 0.9 | 0.7 | 0.8 | 1.0 | 0.8 | 0.7 | 0.4 | 0.3 | 0.7 | 0.9 | 0.8 |
| RO | 0.8 | 1.7 | 2.4 | 2.4 | 2.1 | 2.2 | 2.1 | 1.6 | 2.3 | 2.0 | 1.5 | 1.8 |
| BG | 1.3 | 2.5 | 1.9 | 1.8 | 2.4 | 1.7 | 1.8 | 2.3 | 2.1 | 1.9 | 2.0 | 1.4 |
| UCTE | 62.3 | 57.9 | 71.3 | 69.4 | 66.6 | 61.7 | 55.2 | 79.0 | 71.3 | 77.9 | 72.6 | 67.7 |
| BI-UA | 0.1 | 0.1 | 0.0 | 0.0 | 0.0 | 0.0 | 0.0 | 0.1 | 0.0 | 0.0 | 0.0 | 0.0 |

Remaining capacity with exchanges has been particularly low in February (57.9 GW for UCTE), when remaining capacity was at the lowest for countries like France, Spain and Croatia. Spain and Italy met a low remaining capacity in summer (respectively June and July).

Comments:

- D** On average, the remaining capacity has been higher in 2003 than in 2002, because during most of the months the load at the reference time was lower than in the previous year.
- F** Tensed situations have been met in August during the summer heat spell causing low flows in rivers. The imbalance between offer and demand was solved with import from other countries and special dispensation for temperature limits of water rejected to river in order to allow higher power plants production.
- GR** The remaining capacity with exchanges is higher than the forecasted one, mainly due to the fact that the hydro production is higher in the retrospect and the forced outages and the overhauls are lower.

- I** Exceptional heat wave with very high temperatures and poor rainfall has limited the power generation in the summer period. In June and July, especially, due to weather constraints, the remaining capacity has reduced the value as compared to 2002.
- NL** The remaining capacity in some summer months of 2003 was lower than in 2002 because of the higher non-usable capacity for cooling water restrictions. For several reasons it isn't possible to compose an exact image of the power balance for the Netherlands, and therefore the results in terms of remaining capacity should be considered as of limited significance. TenneT isn't informed properly about the availability of plants and their maximum output, and only receives information about day-ahead programs and power available for system balancing within a bidding system. Furthermore there are hundreds of relative small co-generation producers in industry and agriculture who bring their surplus power on the network, but exact amounts of this decentralised power are not known as it appears as load diminution and as the volume can vary according to industrial activity, climatic conditions, etc. After all should be remarked also that the load as observed by TenneT concerns only the load of the high voltage grid. Embedded and dispersed generation and the connected load in lower voltage networks isn't detected. This generation and load is estimated to be about 15% of the national load.
- P** In January, the margin is lower than the foreseen value due to overhauls and outages in thermal power stations, higher than estimated. In July, the margin is higher than the foreseen value, mainly due to the low charge occurred on the 3rd Wednesday (the margin against the monthly peak value is significantly higher than predicted), and reductions in overhauls and outages. The remaining capacity maintains comfortable levels. However, as it depends strongly on hydro power stations, the remaining capacity is only totally available in short periods.
- PL** Remaining capacity is available continuously.
- RO** The remaining capacity with exchanges was lower than in the previous year because units with more than 750 MW net power were switched off for refurbishment. The remaining capacity with exchanges was permanently higher than the maximum peak load by at least 11%.

4. Energy Balance: detailed results

The constituent elements of the energy balance for individual UCTE countries in 2003 and 2002 are presented in the appendix (Table B/1).

4.1 Electricity production

In 2003, net electricity production in the UCTE countries was 2433 TWh, which represents an increase of 2.8% compared to the generation for the previous year (with 2003's perimeter). The respective contributions of hydroelectric, nuclear and conventional thermal plants, together with other sources, to total electricity production in each country are shown in TABLE 8.

4.1.1 Hydroelectric power plants

FIGURE G1 shows annual electricity production in the various countries. Table 9 shows the capacity utilisation factor of hydroelectric plants in 2003, compared to the results of the 2002 retrospect, for the UCTE countries. The capacity utilisation factor (in %) is calculated as the ratio of electricity produced over the period considered to the theoretical electricity production under conditions of maximum potential capacity.

4.1.1 Hydroelectric power plants

FIGURE G1 shows annual electricity production in the various countries. Table 9 shows the capacity utilisation factor of hydroelectric plants in 2003, compared to the results of the 2002 retrospect, for the UCTE countries. The capacity utilisation factor (in %) is calculated as the ratio of electricity produced over the period considered to the theoretical electricity production under conditions of maximum potential capacity.

Table 8

Structure of generation 2003

Results in TWh

| Country | National generation 2002 | Hydro power stations | Nuclear power stations | Conv. power stations | Renewable energy power stations | Not clearly identified sources | National generation 2003 | Variation 2003-2002 |
|------------------------------|--------------------------|----------------------|------------------------|----------------------|---------------------------------|--------------------------------|--------------------------|---------------------|
| | TWh | % | % | % | % | % | TWh | % |
| B | 78.0 | 1.6 | 56.0 | 41.1 | 1.2 | 0.0 | 80.3 | 2.9 |
| D | 545.0 | 4.5 | 27.9 | 63.2 | 4.5 | 0.0 | 560.4 | 2.8 |
| E | 211.9 | 18.9 | 26.1 | 48.7 | 6.3 | 0.0 | 227.2 | 7.2 |
| F | 516.6 | 11.5 | 80.0 | 8.3 | 0.2 | 0.0 | 524.77 | 1.6 |
| GR | 45.0 | 10.7 | 0.0 | 87.8 | 1.4 | 0.0 | 48.5 | 7.7 |
| I | 270.8 | 15.6 | 0.0 | 82.1 | 2.3 | 0.0 | 279.0 | 3.2 |
| SLO | 13.0 | 21.8 | 40.6 | 37.5 | 0.0 | 0.0 | 12.2 | 3.2 |
| HR | 2.1 | 0.0 | 2.0 | 0.0 | 0.0 | 4.0 | 0.3 | 8.4 |
| BiH | 10.6 | 41.1 | 0.0 | 58.9 | 0.0 | 0.0 | 11.2 | 5.7 |
| FYROM | 5.6 | 21.8 | 0.0 | 78.2 | 0.0 | 0.0 | 6.3 | 11.6 |
| SCG | 35.6 | 29.3 | 0.0 | 70.7 | 0.0 | 0.0 | 36.5 | 2.6 |
| L | 3.5 | 27.1 | 0.0 | 72.9 | 0.0 | 0.0 | 3.5 | - 0.9 |
| NL | 92.4 | 0.1 | 4.1 | 92.0 | 3.9 | 0.0 | 93.2 | 0.9 |
| A | 62.5 | 53.7 | 0.0 | 39.8 | 0.0 | 0.0 | 59.9 | - 4.1 |
| P | 39.4 | 38.3 | 0.0 | 59.0 | 2.7 | 0.0 | 40.7 | 3.3 |
| CH | 65.0 | 55.0 | 40.6 | 4.4 | 0.0 | 0.0 | 66.3 | 1.9 |
| CZ | 70.4 | 2.3 | 31.8 | 65.8 | 0.0 | 0.0 | 76.7 | 8.9 |
| H | 32.9 | 0.6 | 33.0 | 59.0 | 0.3 | 7.0 | 31.5 | - 4.3 |
| PL | 132.0 | 2.2 | 0.0 | 97.6 | 0.2 | 0.0 | 139.1 | 5.3 |
| SK | 30.6 | 12.1 | 57.1 | 21.5 | 0.0 | 9.3 | 28.9 | - 5.6 |
| RO | 50.4 | 25.2 | 8.9 | 65.9 | 0.0 | 0.0 | 51.5 | 2.2 |
| BG | 36.9 | 7.6 | 44.2 | 47.4 | 0.9 | 0.0 | 36.3 | - 1.5 |
| UCTE (2003 perimeter) | 2366.9 | 12.8 | 32.4 | 52.2 | 2.2 | 0.4 | 2432.9 | 2.8 |
| UCTE (2002 perimeter) | 2261.6 | 12.6 | 33.00 | 51.8 | 2.3 | 0.4 | 2326.5 | 2.9 |
| BI-UA | 7.4 | 1.3 | 0.0 | 98.7 | 0.0 | 0.0 | 7.4 | 0.0 |

Figure G1

Electricity production in hydroelectric power plants Retrospect 2003

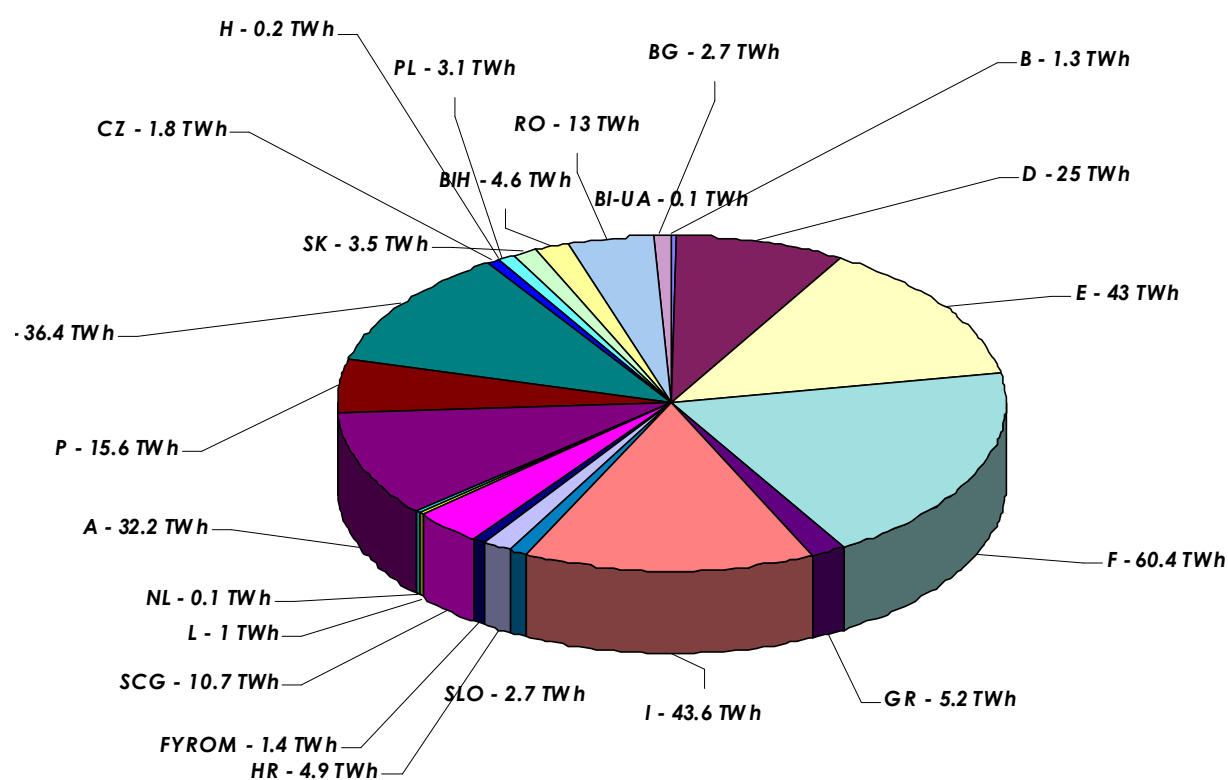

Table 9 | Hydro power plants

| Country | Maximum capacity January | | Production | | Capacity utilisation | |
|---------------|-----------------------------|--------------|--------------|--------------|----------------------|-------------|
| | 2002 | 2003 | 2002 | 2003 | 2002 | 2003 |
| | GW | GW | TWh | TWh | % | % |
| B | 1.4 | 1.4 | 1.5 | 1.3 | 12.2 | 10.6 |
| D | 9.3 | 7.8 | 27.9 | 25.0 | 34.2 | 36.6 |
| E | 18.0 | 18.1 | 26.0 | 43.0 | 16.5 | 27.2 |
| F | 23.9 | 24.3 | 59.7 | 60.4 | 28.5 | 28.4 |
| GR | 3.1 | 3.1 | 3.4 | 5.2 | 12.5 | 19.4 |
| I | 20.4 | 20.5 | 46.6 | 43.6 | 26.1 | 24.3 |
| SLO | 0.8 | 0.8 | 3.0 | 2.7 | 42.3 | 36.3 |
| HR | 2.1 | 2.1 | 5.4 | 4.9 | 29.4 | 26.6 |
| BiH | 2.0 | 2.0 | 4.6 | 4.6 | 25.7 | 25.7 |
| FYROM | 0.4 | 0.4 | 0.8 | 1.4 | 20.6 | 37.4 |
| SCG | 3.5 | 3.5 | 11.7 | 10.7 | 38.3 | 34.9 |
| L | 1.1 | 1.1 | 1.0 | 1.0 | 10.3 | 9.6 |
| NL | 0.0 | 0.0 | 0.1 | 0.1 | - | - |
| A | 11.2 | 11.2 | 38.1 | 32.2 | 38.8 | 32.8 |
| P | 4.4 | 4.4 | 8.0 | 15.6 | 20.8 | 40.2 |
| CH | 13.2 | 13.2 | 36.5 | 36.4 | 31.6 | 31.5 |
| CZ | 2.2 | 2.1 | 2.8 | 1.8 | 14.5 | 9.8 |
| H | 0.0 | 0.0 | 0.2 | 0.2 | - | 49.6 |
| PL | 2.2 | 2.1 | 3.7 | 3.1 | 19.1 | 16.6 |
| SK | 2.4 | 2.4 | 5.3 | 3.5 | 25.2 | 16.6 |
| RO | 5.9 | 5.9 | 15.8 | 13.0 | 30.4 | 25.0 |
| BG | 2.7 | 2.7 | 2.4 | 2.7 | 10.0 | 11.5 |
| UCTE** | 130.4 | 129.4 | 304.6 | 312.5 | 26.7 | 27.6 |
| BI-UA | 0.0 | 0.0 | 0.1 | 0.1 | 42.3 | 42.3 |

** as from 2003 perimeter

In 2003, the production has been characterised by higher hydro conditions in Spain, Portugal and Greece. For other countries, production in 2003 was equal or lower than in 2002.

Comments:

- D** Hydraulicity decreasing to 0.93 was considerably below the multi-annual average. Consequently, there was a decrease in hydro generation of about 10% as compared with the previous year.
- E** Hydro production in 2003 (43 TWh) has been much higher than in 2002 (26 TWh) due to better hydro conditions.
- F** The hydro-electric generation dropped from 2% as compared to 2002, in relation with a strong deficit in hydro-electric generation since June due to the drought.
- GR** In 2003 the hydro generation presented an increase with respect to 2002 because the hydro conditions were more favourable than those of 2002.
- SLO** The hydro generation was smaller in 2003 as compared to 2002, mainly because of the dry conditions observed in the period from April to October 2003.
- HR** Due to dry conditions and low values of water power HPPs produced 478 GWh less energy than in the year 2002. Reversible HPP Velebit played significant role working as pump, although it produced 8 GWh less energy than in the year 2002 (at the end of 2003 one unit came out of service because of damage).
- A** Generally the rainfall was under the long time average. Nearly all-over Austria the rainfall averaged about 70 to 90% of the expectancy, regional even below 70%.
- NL** Hydro is only a small share, the given value is an estimation, no specific information available.

- P** The very positive hydro conditions, with a hydroelectric capacity factor of 1.33, have incremented the hydro production to the highest production ever.
- CZ** Hydro power stations production was still limited by destruction of the parts of the equipment (mostly Orlik power station) caused by the flood on the Vltava river in August 2002.
- SK** The very dry weather, especially in the second half of the year, had a strong impact on the production of hydro power stations (2003 generation is approx. 67% of 2002).
- RO** The production in hydro units was 17% lower than in the previous year, due to the extended draught period registered during 2003.
- FY ROM** Hydro production in 2003 has been higher than in 2002, due to better hydro condition.

4.1.2 Nuclear power plants

Table 10 shows the capacity utilisation factor of nuclear power plants in 2003, compared to the results of the 2002 retrospect, for the UCTE countries.

| Country | Maximum capacity January | | Production | | Capacity utilisation | |
|---------------|-----------------------------|--------------|--------------|--------------|----------------------|-------------|
| | 2002 GW | 2003 GW | 2002 TWh | 2003 TWh | 2002 % | 2003 % |
| | B | 5.8 | 5.8 | 45.0 | 45.0 | 88.6 |
| D | 20.7 | 21.1 | 156.3 | 156.4 | 86.2 | 84.6 |
| E | 7.6 | 7.7 | 60.3 | 59.2 | 90.6 | 87.6 |
| F | 63.2 | 63.4 | 415.5 | 420.0 | 75.0 | 75.6 |
| GR | - | - | - | - | - | - |
| I | - | - | - | - | - | - |
| SLO | 0.7 | 0.7 | 5.3 | 5.0 | 86.5 | 84.6 |
| HR | - | - | - | - | - | - |
| BiH | - | - | - | - | - | - |
| FYROM | - | - | - | - | - | - |
| SCG | - | - | - | - | - | - |
| L | - | - | - | - | - | - |
| NL | 0.4 | 0.4 | 3.7 | 3.8 | 100.0 | 96.6 |
| A | - | - | - | - | - | - |
| P | - | - | - | - | - | - |
| CH | 3.2 | 3.2 | 25.7 | 26.9 | 91.7 | 96.1 |
| CZ | 1.6 | 2.6 | 17.6 | 24.4 | 93.1 | 85.9 |
| H | 1.8 | 1.8 | 13.1 | 10.4 | 83.1 | 67.0 |
| PL | - | - | - | - | - | -16.6 |
| SK | 2.6 | 2.6 | 16.5 | 16.5 | 72.4 | 72.4 |
| RO | 0.7 | 0.7 | 5.1 | 4.6 | 88.9 | 79.5 |
| BG | 2.9 | 2.9 | 18.8 | 16.0 | 74.5 | 63.6 |
| UCTE** | 111.1 | 112.8 | 782.9 | 788.2 | 80.4 | 79.7 |
| BI-UA | - | - | - | - | - | - |

** as from 2003 perimeter

Generation from nuclear power stations has been approx. 5.3 TWh higher in 2003 as compared to 2002, due to the increase in the maximum capacity (the utilisation capacity remained stable). It mainly results from the commissioning of a new unit in Czech Republic and the long unavailability of one unit in Hungary.

Comments:

- D** The total energy generated by nuclear power stations has been stable at a high level.

- E** Generation has remained stable in 2003 as compared to 2002.
- F** The nuclear power stations generation increased by 1% in 2003, despite drops in production due to high rivers' temperatures during the summer heat wave.
- SLO** Nuclear generation in 2003 has been 7% lower than in 2002, owing to a low production in summer (dry conditions leading to a low level for Sava river).
- HR** There is no nuclear power plant situated within Croatia. However, Croatia is entitled to half of the production of nuclear power plant Krško. During the year 2003 energy delivered from NPP Krško was taken into account as imported energy.
- CZ** Significant increasing of nuclear power stations production (from 17,6 to 24,4 TWh) was caused by the successful completion of the operational tests on Temelin unit 2 and beginning of its regular operation in April 2003.
- H** One of the four units of Paks Nuclear Power Plant has been out of service since April 2003 when some fuel assemblies mechanically damaged the cleaning tank.
- RO** The nuclear unit production was 11% lower than in 2002 because in the period 08.24-09.19 the nuclear unit was switched off due to lack of cooling water, caused by the draught in that period.

4.1.3 Conventional thermal power plants

Table 11 shows the capacity utilisation factor of conventional thermal power plants in 2003, compared to the results of the 2002 retrospect, for the UCTE countries.

| Country | Maximum capacity January | | Production | | Capacity utilisation | |
|---------------|-----------------------------|--------------|---------------|---------------|----------------------|-------------|
| | 2002 GW | 2003 GW | 2002 TWh | 2003 TWh | 2002 % | 2003 % |
| | B | 8.2 | 8.2 | 31.5 | 33.0 | 43.9 |
| D | 66.9 | 67.8 | 339.7 | 354.0 | 58.0 | 59.6 |
| E | 24.3 | 26.4 | 114.5 | 110.6 | 53.8 | 47.9 |
| F | 23.5 | 23.0 | 40.2 | 43.3 | 19.5 | 21.5 |
| GR | 6.3 | 6.8 | 41.3 | 42.6 | 74.9 | 71.8 |
| I | 54.7 | 54.6 | 218.4 | 229.0 | 45.6 | 47.9 |
| SLO | 1.2 | 1.3 | 4.7 | 4.6 | 45.0 | 41.5 |
| HR | 1.6 | 2.0 | 5.9 | 6.7 | 42.1 | 38.5 |
| BiH | 1.8 | 1.8 | 6.6 | 6.6 | 42.1 | 42.1 |
| FYROM | 0.9 | 0.9 | 4.9 | 4.9 | 61.2 | 61.7 |
| SCG | 6.4 | 6.4 | 23.8 | 25.8 | 42.5 | 46.0 |
| L | 0.4 | 0.5 | 2.5 | 2.6 | 72.7 | 62.7 |
| NL | 17.5 | 17.5 | 85.4 | 85.7 | 55.7 | 56.0 |
| A | 5.6 | 5.6 | 19.7 | 23.8 | 40.2 | 48.6 |
| P | 5.1 | 5.5 | 30.5 | 24.0 | 68.3 | 50.2 |
| CH | 0.6 | 0.6 | 0.0 | 2.9 | 0.3 | 55.0 |
| CZ | 10.5 | 10.5 | 50.0 | 50.5 | 54.4 | 54.9 |
| H | 5.4 | 5.6 | 17.5 | 18.6 | 37.0 | 38.0 |
| PL | 31.3 | 29.0 | 128.2 | 135.7 | 46.8 | 53.4 |
| SK | 2.3 | 2.3 | 5.9 | 6.2 | 29.3 | 30.8 |
| RO | 9.5 | 9.5 | 29.5 | 34.0 | 35.5 | 40.9 |
| BG | 6.7 | 6.7 | 15.5 | 17.2 | 26.4 | 29.3 |
| UCTE** | 293.0 | 294.8 | 1221.5 | 1269.6 | 47.6 | 49.2 |
| BI-UA | 2.3 | 2.5 | 5.9 | 7.3 | 29.3 | 33.2 |

** as from 2003 perimeter

In 2003, electricity production from conventional thermal power plants in the UCTE was 1269.6 TWh, which represents an increase of 48.1 TWh (+3.9%) with regards to the previous year.

Comments:

- D** The generation of conventional thermal power stations has increased by about 4%.
- E** The thermal contribution has been slightly lower than in 2002 due to the higher hydro production and higher production dealing with renewable.
- F** Conventional thermal power stations generation has increased by 6%, due to its role in providing power during peak load periods so as to achieve balance between power generation and consumption.
- GR** In 2003 the generation of the thermal power plants was slightly higher than that in 2002. The contribution of the different fuels was: lignite 65%, natural gas 16% and oil 7%.
- I** Thermal power generation has been critical during the summer. A thermal generating unavailability due to failures and environmental constraints increased appreciably.
- SLO** The thermal power plants generation has been in 2003 5% lower than in 2002, mostly because of maintenance of the biggest block of thermal power plant Sostanj in July and August.
- HR** Thermal power plants produced 806 GWh more energy than in the year 2002, in spite of lower production of combined TPP TE-TO Zagreb (due to gas supply limitation and prolonged warranty testing of new production units) and TPP Plomin 1 (due to prolonged overhaul).
- NL** The given share is derived from data of our National Statistics Organisation. TenneT isn't informed with specific information such as fueling, performance and constraints.
- RO** The production in thermal units was 15% higher than in 2002. These units compensated both for the reduced production in run-on-the-river hydro units and for the unplanned switch off of nuclear unit due to the draught.

4.1.4 Renewable energy sources generation

| Table 11.2 | National generation, renewable energy sources | | | | | | | | | | | | | | | | Results in TWh | | | | | | | |
|-------------|---|------|------|-----|-----|-----|-----|-----|-----|-----|-----|-----|-----|-----|-----|-----|----------------|-----|-----|-----|-----|-----|-------------|----------|
| | B | D | E | F | GR | I | SLO | HR | BiH | FYR | SCG | L | NL | A | P | CH | CZ | H | PL | SK | RO | BG | UCTE* | BI UA |
| 2002 | 0.0 | 21.1 | 11.1 | 1.2 | 0.3 | 5.8 | 0.0 | 0.0 | 0.0 | 0.0 | 0.0 | 0.0 | 3.2 | 0.0 | 0.9 | 0.9 | 0.0 | 0.0 | 0.1 | 0.0 | 0.0 | 0.0 | 44.6 | 0.0 |
| 2003 | 1.0 | 25.0 | 14.3 | 1.0 | 0.7 | 6.4 | 0.0 | 0.0 | 0.0 | 0.0 | 0.0 | 0.0 | 3.6 | 0.0 | 1.1 | 0.0 | 0.0 | 0.1 | 0.3 | 0.0 | 0.0 | 0.0 | 53.8 | 0.0 |

* as from 2003 perimeter

Electricity production from renewable sources accounts for 53.8 TWh in 2003 ; it represents an early 21% increase compared to 2002.

Comments:

- D** The generation of wind power stations has increased by about 20%.
- E** There has been a 33% increase in renewable, mainly due to wind power plants.
- F** Renewable energy sources generation has increased by 5%.
- GR** There was no significant contribution of the renewable generation to the total generation.

- I** The production has signed an increase of 10% with respect to 2002.
- A** "Renewable" (except hydro power plants > 10MW) is included in "Not clearly identified power stations".
- NL** The given value is an estimation, no specific information is available.
- P** The growth of wind production has continued this year with an increment of 40%, and has reached 1% of total consumption. The renewable thermal production maintains the previous year's level. However, the value indicated in this report is higher because we changed the classification criteria for small independent producers, i.e. in the past we considered as renewable only the wind power and the municipal waste power, but since this year we added the biomass producers and other waste producers considered renewable according to the Portuguese law (and according to UCTE definition).
- CZ** The rate of the renewable energy sources is quite negligible.
- PL** A slight increase of renewable energy sources generation has been noticed.
- SK** The wind power station (2.4 MW) in the western part of Slovakia, in Cerovo, has been in trial operation since October 2003.

4.2 Electricity exchanges

The volume of electricity exchanges (imports - exports) in the UCTE countries in 2003 represented 13.5 TWh export, higher than the corresponding figure for the previous year by 0.5 TWh.

TABLE 12 shows the balance of electricity exchanges and the proportion of the electricity consumption in 2003 for the UCTE countries. Results are compared with the balance for 2002.

| Country | Balance of physical exchanges (import - export) | | | | Results in TWh | |
|---------------|---|---------------|------------------------|--------------|----------------|---------------|
| | Balance | | Balance of consumption | | Consumption | |
| | 2002 TWh | 2003 TWh | 2002 % | 2003 % | 2002 TWh | 2003 TWh |
| B | 7.5 | 6.3 | 8.9 | 7.4 | 84.0 | 85.2 |
| D | 0.7 | - 8.1 | 0.1 | - 1.5 | 539.4 | 545.3 |
| E | 5.3 | 1.3 | 2.5 | 0.6 | 210.3 | 223.7 |
| F | - 76.9 | - 66.6 | - 17.8 | - 14.8 | 432.3 | 450.8 |
| GR | 2.9 | 2.2 | 6.2 | 4.3 | 47.0 | 49.8 |
| I | 50.7 | 50.9 | 16.3 | 15.9 | 310.7 | 319.5 |
| SLO | - 1.3 | 0.2 | - 11.1 | - 1.3 | 11.7 | 12.4 |
| HR | 3.5 | 3.9 | 23.5 | 25.2 | 14.9 | 15.4 |
| BiH | - 1.1 | - 1.1 | - 11.6 | - 10.9 | 9.5 | 10.1 |
| FYROM | 1.2 | 1.0 | 18.7 | 13.2 | 6.4 | 7.2 |
| SCG | 3.3 | 3.1 | 8.6 | 7.9 | 38.3 | 39.1 |
| L | 3.7 | 3.8 | 61.6 | 61.4 | 6.0 | 6.1 |
| NL | 16.4 | 17.0 | 15.1 | 15.4 | 108.8 | 110.2 |
| A | 0.7 | 5.6 | 2.8 | 8.9 | 60.7 | 62.6 |
| P | 1.9 | 2.8 | 4.7 | 6.5 | 40.8 | 43.0 |
| CH | - 3.2 | - 3.1 | - 5.5 | - 5.2 | 58.1 | 60.3 |
| CZ | - 11.4 | - 16.2 | - 19.5 | - 27.0 | 58.5 | 59.9 |
| H | 4.3 | 6.9 | 11.6 | 18.0 | 37.2 | 38.4 |
| PL | - 7.1 | - 10.2 | - 5.8 | - 8.0 | 122.7 | 126.7 |
| SK | - 4.2 | - 2.2 | - 16.1 | - 8.3 | 26.1 | 26.4 |
| RO | - 2.9 | - 2.1 | - 6.0 | - 4.2 | 48.3 | 49.4 |
| BG | - 6.3 | - 5.5 | - 20.8 | - 18.1 | 30.4 | 30.4 |
| UCTE** | - 12.0 | - 13.5 | - 0.5 | - 0.6 | 2303.4 | 2376.1 |
| BI-UA | - 0.7 | - 3.3 | - 43.8 | - 79.0 | 1.6 | 4.1 |

** as from 2003 perimeter

Table B/1 shows the detail of the export and import in 2003 for the UCTE.

The figure here below shows the evolution in physical exchanges for the UCTE (import + export) between 2002 and 2003.

| Physical exchanges TWh | 2001* | 2002* | 2003* | 2003** |
|------------------------|--------------|--------------|--------------|--------------|
| Import | 263.9 | 261.7 | 272.1 | 277.6 |
| Export | 269.2 | 262.8 | 273.7 | 291.2 |
| Import+Export | 533.1 | 524.6 | 545.8 | 568.8 |

* as from 2002 perimeter

** as from 2003 perimeter

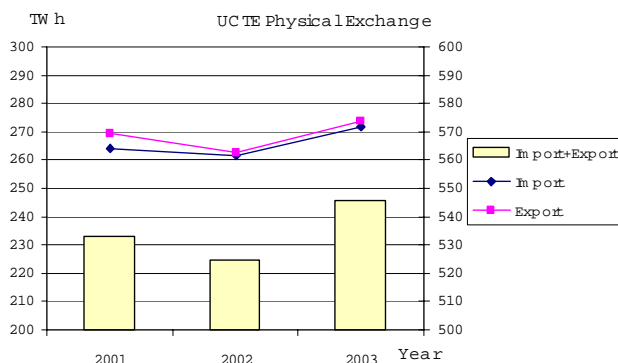

Considering the 2002 perimeter, physical exchanges within UCTE increased by 4% compared to 2002 and were the highest ever recorded. But some structural changes occurred during the year : Germany became a net exporting country whereas France export balance decreased by 10 TWh. Exports from Czech Republic, Poland and Burshtyn Island have significantly increased.

Comments:

D In 2003, electrical energy imports from other countries, amounting 45.8 TWh, had a share of 7 % in the electricity output of overall electricity supply in Germany. They have slightly decreased by 0.5 TWh or -1% as against the previous year. Distinct increases were recorded for imports from the Czech Republic (+21%) and from France (+8 %) (physical flows). Considerable decreases were registered for imports from the Netherlands (-57%), Poland(- 53%), Austria (-22%) and Switzerland (-19%). Measured against physical energy flows across national frontiers, France continues to be by far the country with the highest exports to Germany. It has again increased its share in total German imports to approx. 44%, followed by the Czech Republic (28%), Denmark (9%) Austria (7%) and Switzerland (7%). As compared to the previous year, physical exports of Germany to neighbouring countries substantially rose by +18% to 53.8 TWh. The highest increase in percent was recorded for exports to Denmark (87%) and Sweden (+62%). The Netherlands attained the highest share with 28%, followed by Switzerland (25%) and Austria (18%). Physical exports of Germany are likely to include transits from other countries through Germany. In particular large parts of physical imports flew across Germany to Switzerland and Austria and from there to Italy, or across Germany to the Netherlands. The 2003 export surplus of 8 TWh accounts for more than 1% of German electricity generation. The exchange volume (i.e. the sum of imports and exports) corresponds to about 17% of total generation in Germany.

F The net export balance for international physical exchanges reached 66.6 TWh in 2003, which represents a drop of 14% as compared to the value achieved in 2002. This change is primarily the result of a drop in exports of around 10% (-7.7 TWh) and, to a lesser extent, an increase in electricity imports which almost doubled in volume over 2002 (+3.3TWh). This phenomenon is largely due to changes in electricity prices within the different European markets. For example, 2003 saw changes in the France/Great-Britain and France/Spain price differentials, with the effect of making the Spanish and British markets more attractive. On top of that, demand growth has been higher from 2002 to 2003 (+3.9%) than from 2001 to 2002, with unusual climatic conditions and tensed situations in summer, resulting in a relative drop in exports.

I For the first time since a long period, a reduction in the import has been noted. A strong reduction in export was also observed.

- A** One reason of the increase of the physical import was the reduced hydro production because of the dry weather conditions. The rainfall was under the long time average (values of 70 to 90% of the expectancy).
- P** The liberalisation of the electricity market has strongly incremented the imports.
- CZ** The export of electricity from CZ has been always growing since 1997 (especially to Germany).
- PL** Export to Sweden has slightly increased.
- SK** The import increased by +28.5%, while exports remained at values near those of 2002.
- RO** The export to countries outside UCTE decreased to zero since Bulgaria became also a UCTE member. The monthly sold exchange of Romania was export except for September and October, when exports were reduced to protect the water reserve in reservoirs.

4.3 Electricity consumption

Electricity consumption in the UCTE countries in 2003 reached 2376.1 TWh and exceeded last year's consumption by +72.7 TWh (+3.1%). This demand growth rate is much higher than in the previous years. Fig5 and Table 13 show that in many countries this growth rate exceeded 4%, reaching 6% or more in Austria, Spain, Greece. At the UCTE level the growth rate is of the same order of magnitude in winter and in summer; it results on one hand of the cold periods observed in January and December and on the other hand of the exceptional heat spell in summer.

Figure 5 shows the variation between 2002 and 2003 of the national electricity consumption, during the summer and the winter semester.

Figure 5 | Variation of national electricity consumption during the summer and winter semesters in 2003 with regards 2002

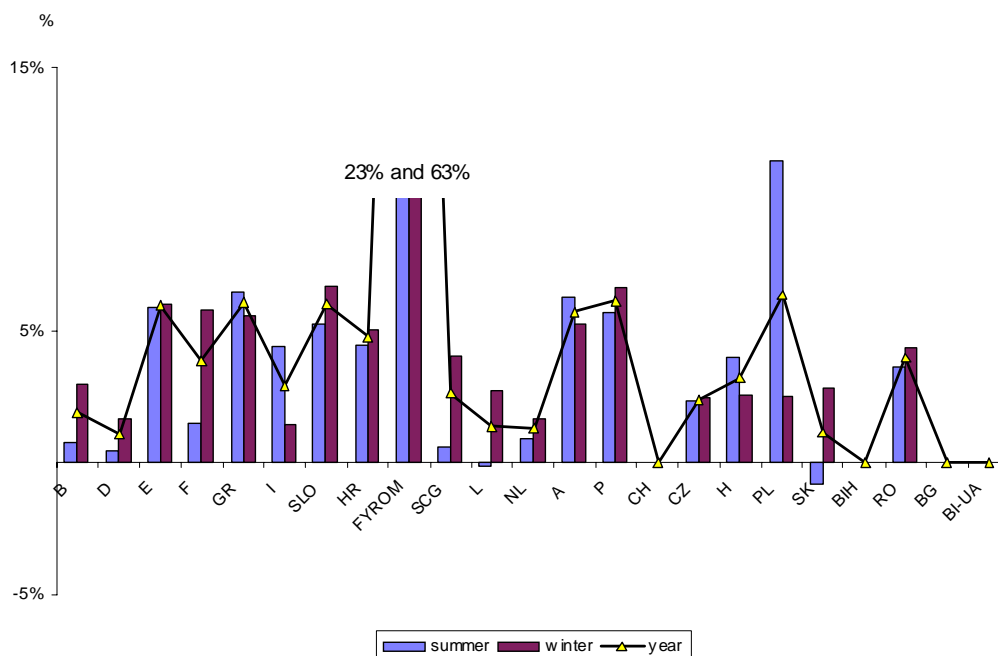

Table 13 | Electricity consumption

| Country | Consumption 2001 | Consumption 2002 | Consumption 2003 | Variation 2003 - 2002 |
|--------------|------------------|------------------|------------------|--------------------------|
| | TWh | TWh | TWh | % |
| B | 83.4 | 84.0 | 85.2 | 1.4 |
| D | 494.8* | 539.4 | 545.3 | 1.1 |
| E | 205.7 | 210.3 | 223.7 | 6.4 |
| F | 437.1 | 432.3 | 450.8 | 4.3 |
| GR | 46.1 | 47.0 | 49.8 | 6.0 |
| I | 304.8 | 310.7 | 319.5 | 2.9 |
| SLO | 11.2 | 11.7 | 12.4 | 5.5 |
| HR | 14.5 | 14.9 | 15.4 | 3.6 |
| BiH | - | 9.5 | 10.1 | 6.3 |
| FYROM | ** | 6.4 | 7.2 | 12.6 |
| SCG | ** | 38.3 | 39.1 | 2.1 |
| L | 5.9 | 6.0 | 6.1 | 2.1 |
| NL | 107.1 | 108.8 | 110.2 | 1.3 |
| A | 52.9 | 60.7 | 62.6 | 3.1 |
| P | 39.9 | 40.7 | 43.0 | 5.4 |
| CH | 57.2 | 58.1 | 60.3 | 3.7 |
| CZ | 58.7 | 58.5 | 59.9 | 2.4 |
| H | 36.8 | 37.2 | 38.4 | 3.2 |
| PL | 125.8 | 122.7 | 126.7 | 3.2 |
| SK | - | 26.1 | 26.4 | 1.1 |
| RO | - | 47.5 | 49.4 | 4.0 |
| BG | - | 30.4 | 30.4 | |
| UCTE* | - | 2303.4 | 2376.1 | 3.2 |
| BI-UA | - | 1.6 | 4.1 | |

2002 data uncomplete

* different perimeter

** 44.9 TWh for FYROM and SCG

*** as from 2003 perimeter

Comments:

- E** During summer, there have been unusual weather conditions, with consequent higher than typical demand values.
- F** 2003 was marked by a particularly contrasted climate, which led to an increase in electricity consumption of 5.5 TWh as compared to a year with normal temperature conditions. This phenomenon is primarily due to the cold spells at the start of the year and in October (approximately + 4.5 TWh). To a less extent, the heat wave in the summer of 2003 had an impact of around + 1 TWh, linked to a greater use of cooling equipment. The 2003 final consumption's increase of 17.4 TWh is due to different climatic conditions met in 2003 compared with 2002 (+8.1 TWh), to an increase of some specific big customers (+2 TWh) and to a still noticeable increase of domestic demand (+7.3 TWh) despite a low growth of the economic activity.
- GR** The consumption was 6% higher than in the previous year but if the growth of the consumption over the last two years is considered, it was 4% per year.
- I** An increase of 4,4% in the summer semester confirmed the demand growth in relation to the big heat wave from June to August.
- SLO** In winter, consumption has been much higher than during the previous years (+6.6%); in summer, consumption evolved according to the trend observed (+5.2%).
- HR** Increase of consumption was 4.76%. Growth was somewhat larger in winter semester (5.04 %) than in summer semester (4.44%). About 40% of increase was caused by larger consumption at distribution level. Consumption increase due to growing number of airconditioning units is continuing, which is specially noticed from June to

- NL** The growth of the consumption is lower than previous years and in winter semester 2003 higher than normal, but no exceptional trends towards climatic conditions can be concluded.
- P** After the smaller increase in energy consumption that occurred in 2002, this year there was a noticeable acceleration. The total consumption has increased by 5.9% relative to last year, or 4.3% considering the effect of temperature correction and number of working days. However, part of this increase is due to the effect of a legal change which allows cogenerators to sell the totality of their generated energy, to profit from the special status regime tariff, therefore enlarging the measured energy consumption supplied by the public grid, which is the scope we consider. The effect of co-generators already bound to this decree is estimated to have incremented energy consumption by about 0.8%.
- PL** There is clearly an increase of consumption in summer semester even if temperature was lower than in 2002.
- SK** The highest increase of consumption was in February and March, due to colder weather than in 2002.
- RO** The consumption in 2003 was 4% higher than in the previous year.

5. Transmission System Adequacy

Transmission system adequacy is analysed regarding three aspects:

- the main developments of the network during the year with information about the newly commissioned lines or transmission devices having a direct or indirect impact on the interconnections and on congestion (by increasing the NTC, by reducing or increasing constraints, by decreasing congestion costs, ...). Appendix 1 shows in detail these main developments in the different UCTE countries;
- the main disturbances which have affected the transmission lines: this information is partly issued from the UCTE "TSO-Forum" sub-group's Report,
- the situation of the transmission system during the year, considering the main congestion observed, especially on the internal interconnections. Since this year's report, information is given about the criticality of congestion seen by each country on interconnection, according to a common index (see here below : "representation of congestion").

5.1 Representation of congestion on interconnection tie lines

For the first time this year, the Retrospect report includes an overview of the congestion on interconnections, gives information on how these congestion are managed, and presents the main congestion on national networks. In the following comments, details are given about the state of congestion for each country with its interconnected neighbours; for each border, and each direction through it, the nature of congestion seen by countries involved is appreciated according to the following index:

| Severity Index | Arrow's color | Annual frequency of occurrence |
|----------------|---------------|--------------------------------|
| n.a. | white | n.a. |
| 0 | green | 0% |
| 1 | blue | 1 - 25% |
| 2 | orange | 26 - 50% |
| 3 | orange | 51 - 75% |
| 4 | red | 76 - 99% |
| 5 | black | 100% |

In order to qualify more precisely the congestion, the table here below has been used to classify more precisely when possible the occurrence according to the season, and hour of the day :

| Season | Hours |
|---------------|------------------|
| Never (N) | Never (N) |
| Spring (Sp) | Varying (V) |
| Autumn (A) | Peak hours (P) |
| Summer (Su) | Night hours (Ni) |
| Winter (W) | Day hours (D) |
| All year (AY) | all day (A) |

Appendix 2 shows a map at the UCTE level summarising the global appreciation of congestion.

5.2 Main results

Of course the Italian blackout which occurred the 28th of September is the main event of the year. UCTE has already published two reports on this event (the final report is available on UCTE web site at http://www.ucte.org/pdf/News/20040427_UCTE_IC_Final_report.pdf).

But in other occasions the UCTE security rules were violated due to high flows on the system and a single important outage could have had severe consequences : it concerns the flows across the Belgian system in March, April, and July and the Austrian north to south 220kV lines in Winter. In addition local blackouts were observed in Portugal and in Croatia. As far as congestion are concerned Italy, Poland, Czech Republic, Austria and Hungary face the more critical situations on the international tie lines but very frequent congestion are also observed in France, Germany and Slovenia.

5.3 Detailed comments

In order to provide a more comprehensive view of the situation in the European power system, the following comments are organised on a geographical logic taking into account the different areas issued from the congestion observed in the UCTE system. Methods for congestion management in each country are specified.

NL Main developments:

A second phase shifter with a nominal capacity of 1000 MVA has been taken inot operation in January in Meeden 380 kV substation. The main purpose of the phase shifters is to manage better the import/export flows of the cross-border line Meeden-Diele between TenneT and Eon-Netz. A first one was already commissioned in September 2002. But the expectation that the import/export capacity of the Netherlands would rise with about 1000 MW couldn't be fulfilled due to changed operational conditions over the last years. The capacitor-banks and shunt-reactors are part of a reactive re-adjustment scheme to better manage the voltage profile over the network in low and heavy load flow situations and to become more independent of reactive power from production units. This will have also some impact on the NTC-values.

Main congestion:

There are no notorious bottlenecks on the Dutch/Belgium cross-border lines themselves, but sometimes imports from Belgium/France or transports from France towards Germany must be restricted because of high loads on the France/Belgium cross-border lines. So it can be said that bottlenecks on other borders lower import/export capacity from the Netherlands. What should be mentioned also is that at the end of October appeared very high transports over the German-Dutch border-lines which reached maximum values on the 27th of October at some evening-hours. These transports, opposite to the normal observed flows, weren't anticipated in operational planning. For at least one hour the operational limits were almost met on the German-Dutch cross frontier-inter-connections and an eventual contingency might have caused an emergency situation for the Netherlands.

Interconnection - Congestion management:

The trade on the borders is liberalised, but existing import/export contracts are respected. When this contracts expire, the whole capacity will be free. That means that today a great part of the capacity can be sold to the market. Together with Elia, Eon Netz and RWE-Net explicit auction for the cross-border lines of the Netherlands are used.

Main congestion:

The main congestion are seen on the French Belgian interconnection, in the Alps and on the Riviera.

| | | | |
|----|----|-----------|---------------------------------|
| GB | F | 2/AY/P | Auction process |
| F | GB | 2/AY/Ni | Auction process |
| F | B | 4/AY/A | Daily prorata (monthly by Elia) |
| B | F | 0 | |
| F | D | 4/AY/A | Priority list, daily |
| D | F | 0 | Prorata, daily |
| F | CH | 4/AY/A | Priority list, daily |
| CH | F | 2/SP,SU | Prorata, daily |
| F | I | 5/AY | Prorata |
| I | F | 0 | Prorata |
| F | E | 4/AY/A | Priority list, daily |
| E | F | 3/SP,A,SU | Prorata, daily |

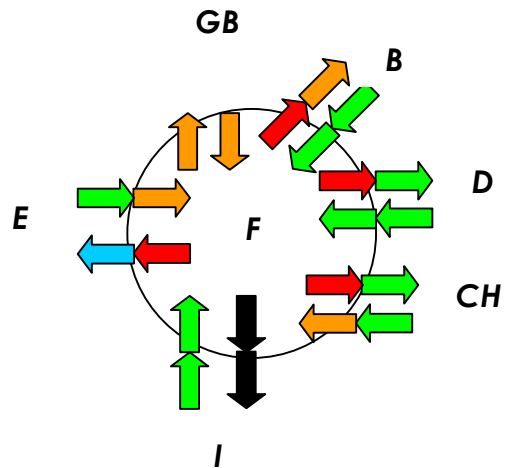

E Main developments:

At the beginning of 2003, Red Eléctrica acquired most of the transmission grid previously belonging to the distribution companies. There is no impact on NTC with Portugal as Cartelle-Lindoso is a new circuit in an existing line, but there is a contribution to the system reliability.

Main disturbances:

The LFC system in Spain was working in pure frequency mode for about 20 minutes as a response to the frequency deviation caused by the disconnection of Italian system from the UCTE.

Interconnection:

As the cross-border capacity allocation is not based on auctions in general (there are only some special situations when explicit auctions are carried out and only for a slice of capacity, this is, when there is a congestion in day-ahead and physical bilateral contracts are affected), it is not possible to define a realistic "capacity price" for all the available commercial capacity in any way. Concerning congestion on the French border, index seen on the map is not representative of the real congestion level existing in this interconnection, since the non-co-ordination of the methods applied for cross-border allocation at both sides of the border masks the congestion.

| | | | |
|---|---|-----------|------|
| F | E | 1/W,A,SP | 0/Su |
| E | F | 0 | |
| P | E | 0 | |
| E | P | 1/A,SP,Su | 0/W |

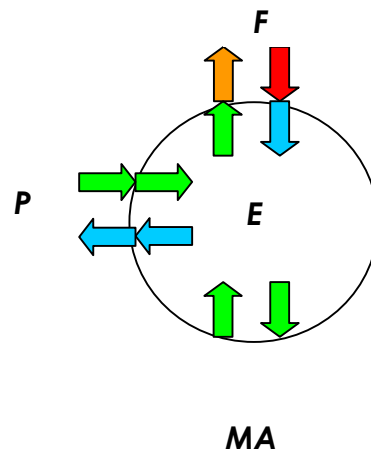

P Main disturbances:

On 2nd August at 14:17h, a large incident occurred, causing a southern region blackout affecting 550 MW of load. The origin of the incident, was the consecutive trip of the two 400 kV lines between Palmela and Sines, within one minute interval, caused by two large forest fires under these lines. After these trips, the two 150 kV lines Palmela-Évora/Pegões and Palmela-Monte da Pedra were the only path linking the southern grid to the rest of the Portuguese network. As the total power flow through these lines exceeded 700 MW they tripped inevitably by overload. An island network was then created in the South. As in this network the 1250 MW generation (four 300 MW coal thermal units and one diesel gas turbine of 70 MW) was excessive for the nearly 560 MW of load, the thermal units reduced quickly, stabilising the frequency near 51.5 Hz. Two minutes after the island creation, the trip of two thermal units occurred, caused by thermal problems (steam-boilers trips) and then problems with low frequency. The remaining thermal units increased their generation, there was load shedding (100 MW), but fre

approximately 15 minutes afterwards there was a new trip on one 400 kV line followed by another trip on the other 400 kV line. At this point the generation in the southern region was 170 MW (four diesel gas turbines in Tunes) and the regional load was near 500 MW. At that point, to avoid a new trip of 150 kV lines, REN requested the load shedding of some 100 MW. This generation deficit situation would only be solved at 18:51h, with the synchronisation of the first Sines thermal power unit and with the synchronisation of the second unit at about 19:45h, the 400 kV lines were reconnected and the total load restored. The total amount of energy not supplied, until the normal supply situation was reached, is estimated at 1000 MWh.

Main congestion:

Interconnection and management of the congestion:

The trade on the Portugal/Spain interconnection is liberalised. A pro-rata method is used to solve the congestion. With the implementation of the Iberian market this rule could change soon.

P E 0
E P 1/AY/-A

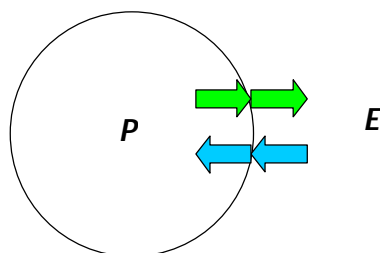

National network:

There occurred a few bottlenecks-congestion in the transmission grid, which consisted in the limitation of transport from North to South, in the drainage of energy produced by the hydro power plants on the Cavado river basin, and in the supply of electricity to the Algarve. This last situation led to a re-dispatch with more significant costs due to the compulsory use of the Tunes diesel power plant. Towards the end of the year it was noted that the heavy use of the interconnection for imports associated with the hydro generation in the North of the country caused a deficit of reactive energy in the south, forcing the use of more expensive thermal power plants in the south.

D Main congestion:

| | | | |
|----|----|------------|--|
| D | NL | 4-5, AY, A | liberalised (explicit auction) |
| NL | D | 4-5, AY, A | liberalised (explicit auction) |
| D | DK | 4, AY/A | D-DK (West) liberalised (explicit auction), D-DK (East)(partly explicit auction) |
| DK | D | 4, AY/A DK | (West) -D liberalised (explicit auction), DK-(East)-D (partly explicit auction) |
| CZ | D | 4, AY/A | liberalised (explicit auction) |
| D | L | 0 | |
| L | D | 0 | |
| D | S | 0 | |
| S | D | 0 | |

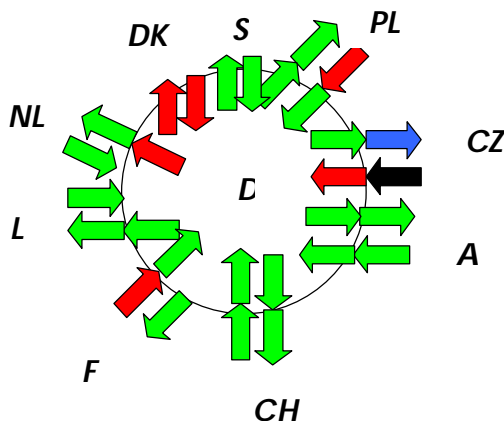

No congestion are reported by the German TSO's at the borders with France, Switzerland, Austria, Poland, Luxembourg and Sweden.

National network:

In case of large energy transits from North to South in Europe (especially to Switzerland), the 380 kV transmission line Engstlatt-Oberjettingen of EnBW is operated in the base case with a high current, up to 100% of its maximum capacity. In this case, an outage of this line (n-1) would lead to overloads on other facilities. Consequently, different topological changes need to be carried out as preventive measures. Because of a general high load flow from North to South during the whole winter, these special topological conditions apply from the end of October until April. To date, problems could be solved and had no influence on transmission capacities with other countries; but generally, the large energy transports from North to South in Europe cause more and more trouble in the grid.

A Main congestion:
Interconnection and management of congestion:

| Interconn. | Capacity | Allocation method | Comment |
|------------|--|------------------------|---|
| A>CZ | 400MW Base | Auction | www.auction-office.at ; www.ceps.cz |
| CZ>A | 200MW Base 100MW Base | Auction | www.auction-office.at ; www.ceps.cz |
| A>I | 110 MW Jan-Apr, Oct-Dec; 100 MW May, Jun, Sep; 50 MW Aug; Base | Splitting of capacity | Only share of A |
| I>A | 110MW Jan-Apr, Oct-Dec; 100MW May, Jun, Sep; 50MW Aug; Base | Splitting of capacity | Only share of A |
| APG>SLO | 300MW Base; 100MW Peak | Splitting of capacity | Only share of A |
| SLO>APG | 300MW Base; 100MW Peak | Splitting of capacity | Only share of A |
| APG>H | 150MW Base April; 150MW Peak, 90MW Off Peak May-Dec | Splitting of direction | Allocation by H |
| H>APG | 100MW Base, 100MW Peak | Splitting of direction | Allocation by A |

Auction: The allocation of the capacity is organised by an auction office
 Splitting of capacity: Each country (TSO) is responsible for 50% of the available capacity. The allocation of each share takes place according to the national laws.
 Splitting of direction: Each country is responsible for a single direction.

Base: 01.01.2003 00:00h – 31.12.2003 24:00h
 Peak: 07.01.2003 – 31.12.2003 Monday to Friday daily 08:00h – 20:00, excepting Austrian holidays

A CZ 0
 CZ A 5 – AY
 A I 5 - AY
 I A 0
 A SLO 5 – AY
 SLO A 0
 A H 0
 H A 5 – AY
 A CH 0
 CH A
 A D 0
 D A 0

NTC 220MW

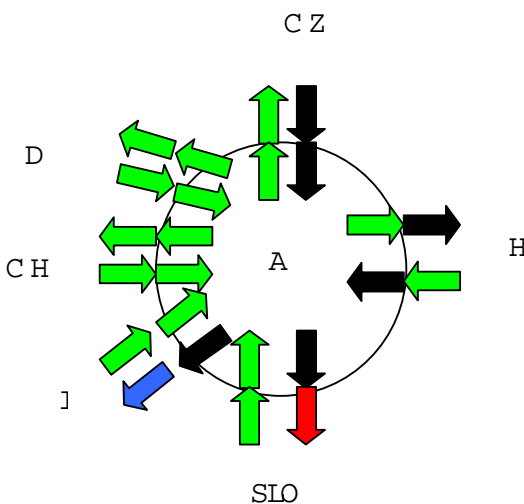

National network:

The main bottlenecks congestion on the Austrian national network occur s on the three 220kV lines from north to the south of Austria. The N-1 criterion was violated specially in the winter season during the night up to 63% of time (February).

CH Main developments:

A second 380 kV circuit between the substation Gösgen in the north of Switzerland and the substation Mettlen in the canton of Lucerne (center of Switzerland) has been put into operation in July 2003. Thanks to this reinforcement the load flow on the existing single 380 kV connection between Gösgen and Mettlen, which was continuously heavily loaded in the past, has been reduced accordingly.

Main disturbances:

On the 30th June 23:48 a circuit breaker in the 380 kV substation of Laufenburg in the north of Switzerland failed to disconnect a line affected by a flashover, leading thus to the loss of one of the three 380 kV bus bars with 7 feeder lines. The first feeders could be re-energized after 15 minutes and the remaining feeders followed within 2 hours, excepted for the affected line. The Swiss transmission grid was again heavily loaded in the winter and in the summer periods. Especially the North-South 380 kV lines crossing the Alps are regularly operated near their thermal limits. In order to manage critical situations, it was necessary to implement congestion management measures several time and to reduce the import and export schedules. The situation was particularly critical on the 24th June because of Italy's high imports and as a consequence of the high temperature on the production pattern in Europe. As a result, very high transit flows were flowing through Switzerland leading to a critical network situation in Switzerland. In the night of the 28th September, a similar situation was registered which led to the tripping of the 380 kV line Mettlen-Lavorgo across the Alps. In the following, ETRANS and the Swiss TSOs took several measures to try to re-close this line and to reduce the overload of the 380 kV line Sils-Soazza (in the South-East of Switzerland) that had resulted. 25 minutes later, the tripping of this line led to a cascading tripping of all lines interconnecting the Italian system with the UCTE system. Before the event, Italy was importing a total of 6651 MW. In Switzerland, the canton Tessin was disconnected from the Swiss system for 20 minutes and the supply of this region was interrupted. Switzerland helped to reconnect the Italian system to the UCTE in the following hours and re-energize the first tie-line to Italy 20 minutes later. Substantial export exchanges of about 2100 MW were already on line at 06:00 between Switzerland and Italy.

Main congestion:

The 380 kV transmission lines and the 220 kV transmission lines between the South of Switzerland and Italy are often heavy loaded especially in the night and on the week end or holidays. Main reason for this situation was the continuous increase of the imports of Italy in the last years. Reductions of the exports to Italy were in many occasions necessary during the year 2003 in order to maintain the n-1 security of the Swiss transmission grid.

Interconnection - Congestion management:

The trade on the interconnection for the Swiss share (half of the ATC value) is shared between the Swiss utilities (multilateral agreement). Congestion management is based on Swiss internal redispatch, topology measures in Switzerland and reduction with neighbouring countries is agreed between Swiss utilities.

| | | | |
|----|----|--------|---------------|
| CH | I | 4/AY/A | especially Ni |
| I | CH | 0 | |
| CH | F | 0 | |
| F | CH | 0 | |
| CH | D | 0 | |
| D | CH | 0 | |
| CH | A | 0 | |
| A | CH | 0 | |

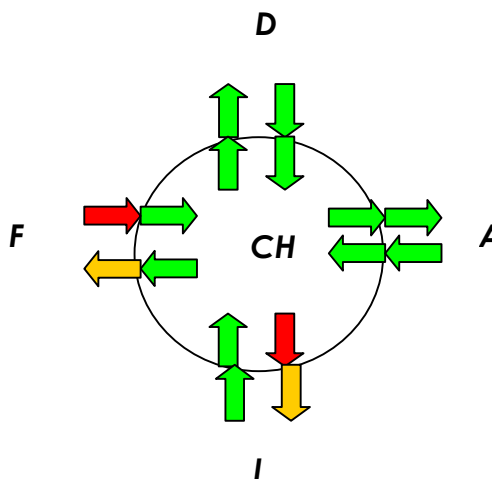

CZ Main disturbances:

On the 14th of August an incident occurred in the northern part of Czech transmission grid causing outage of two power plants with total installed capacity 1 450 MW. The origin of the incident was a strong storm (squall) with very sharp and local effect which led to destruction of two towers of a double line 400 kV from substation Hradec to power station Prunerov. The consumers had not been affected. The line was given to the operation after reconstruction on the 28th of October.

Main congestion:

Interconnection-Management of congestion:

The trade is liberalised on the interconnection. Explicit auctions are used on the cross-border with Germany (E-ON and VE-T), Austria and Slovakia. The cross-border with Poland, is ruled through a one side auction.

Maximal monthly auction prices were as follows:

| | |
|----------------|------------------------------|
| CZ -> D(VE-T) | 3750,00 EUR/MW in December |
| D (VE-T)-> CZ | 11,11 EUR/MW in May |
| D (E.ON) -> CZ | 10,00 EUR/MW in January |
| CZ -> D (E.ON) | 2610,10 EUR /MW in December |
| CZ -> A | 1483,00 EUR /MW in September |
| PL -> CZ | 972,71 EUR /MW in November |
| CZ -> SK | 217,00 EUR/MW in July |
| SK -> CZ | 268,00 EUR/MW inDecember |

| | | |
|-------|--------|--------------------------------------|
| CZ D | 5/AY/A | 100% real using - All days |
| D CZ | 1/AY/V | Some hours |
| CZ A | 5/AY/A | 100% real using - All days |
| A CZ | 0 | |
| CZ PL | 0 | |
| PL CZ | 5/AY/D | 100% real using - day hours only |
| CZ SK | 4/AY/V | 40% real using of allocated capacity |
| SK CZ | 3/AY/V | 20% real using of allocated capacity |

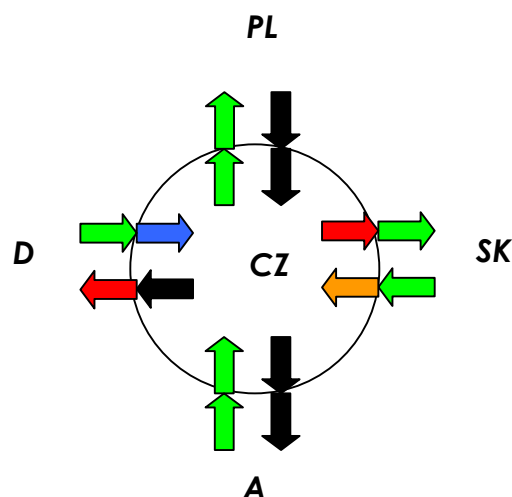

National network:

| Bottleneck congestion | Severity of congestion (0 to 5 – Season - Hours) | Remarks |
|-----------------------|---|---|
| V243,4 | 1 / Sp/P, Su / D, A/P | Tie lines 220kV CZ-A – unexpected flows |
| T Sokolnice | 1 / Su / D | Transformer 400/220 kV– unexpected flows |
| V245,6 1 | W / P | Tie lines 220kV CZ-PL– unexpected flows |
| V445,6 1 | W / P | Tie lines 400kV CZ-VE-T– unexpected flows |

PL Main developments:

The new lines, Dobrzen – Wielopole 400 kV and Dobrzen – Albrechtice 400 kV will strengthen the security of the Polish power grid operation and improve the transmission of energy between Poland and the Czech Republic.

Main disturbances:

On 20th February 2003 due to the extreme atmospheric conditions (heavy icing) several towers of 400 kV inter-connection Krosno-Lemesany were destroyed. The connection was rebuilt on 15th March. On 8th September 2003 due to failure of protection device in substation Rogowiec 3x 370 MW units in power station Belchatow were disconnected for about one hour from the power grid.

Main congestion:

Although many network constraints occur in Polish transmission system it is difficult to determine any structural bottlenecks (i.e. those related to the particular sets of lines over longer periods of time). The actual network constraints heavily depend on given system load, network configuration and generation pattern and vary according to their changes. Most of network constraints result from limitations related to voltage stability in a given area, not

from permissible loading of transmission lines themselves (apart from some cases of the subtransmission 110 kV lines). To manage congestion coming from these network constraints Polish TSO has to re-dispatch the generation.

Interconnection - Management of congestion

In the year 2003 cross border power exchange was monopolised. Starting from May, 1st 2004 cross border power exchange is liberalised and PSE allocates capacities via explicit auction process. PSE as TSO determines ATC values on the whole D/CZ/SK profile which are a subject of the allocation process

| | | | |
|---------|---------|---------|------------------------------|
| PL | D/CZ/SK | 5/AY/V* | |
| D/CZ/SK | PL | 0 | lack of commercial contracts |
| PL | S | 5/AY/A | commercial DC link |
| S | PL | 0 | commercial DC link |
| PL | UA | 0 | NTC = 0 |
| UA | PL | 4/AY/A | radial operation |
| PL | BY | 0 | NTC = 0 |
| BY | PL | 4/AY/A | island operation |

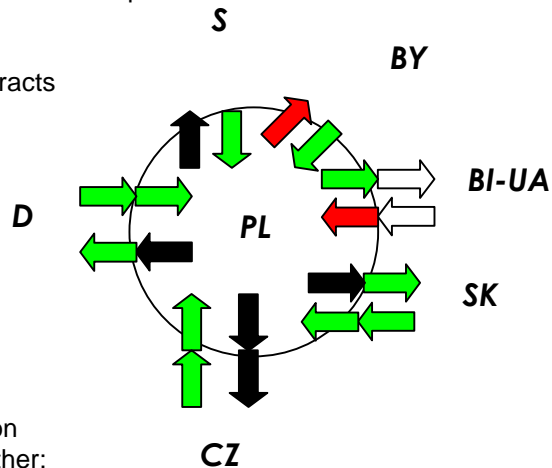

*in 2003 as in the previous years, PSE managed congestion on all synchronous international tie-lines (to D, CZ and SK) together; thus the description of the congestion situation is given for this whole profile.

SK Main developments:

A new transformer T402 (350 MVA ; 400 kV/110 kV) has been commissioned in June 2003 in the substation Horna Zdana.

Main congestion:

In May 2003 SEPS started common monthly auction process with CEPS (border SK-CZ). Despite the fact in monthly auctions all available capacities were allocated to traders, daily schedules did not use all available capacities and new traders were able to obtain a capacity for a next day. Internal network : in case of particular operation conditions (mainly during the controlled line disconnection between CEPS - APG) some bottlenecks on SEPS - MAVIR profile can occur. Due to its geographic location Slovakia is significantly involved in electricity transits, especially in the north-south direction (from Poland to Hungary), as well as in the east-west direction. Existing 400 and 220 kV connections with the Czech Republic, Hungary, Poland, and Ukraine are fully loaded with electricity exchanges among the above states, and have a significant share in electricity marketing in the Central and South-European region. Strengthening of cross-border lines and the solution of possible bottlenecks was a subject of a number of negotiations held in 2003 among transmission system operators of the surrounding countries. Particular attention was paid to the methodology of non-discriminatory allocation of transmission capacities at international profiles by application of an auction mechanism.

Interconnection and management of the congestion

The trade of the interconnection is liberalised on all borders. SEPS performs explicit auctions to allocate capacities of cross border tie-lines

| | | |
|----|----|--------|
| SK | CZ | 0/AY/A |
| CZ | SK | 0/AY/A |
| SK | H | 3/AY/P |
| H | SK | 0 |
| SK | UA | 0 |
| UA | SK | 0 |
| SK | PL | 0 |
| PL | SK | 0 |

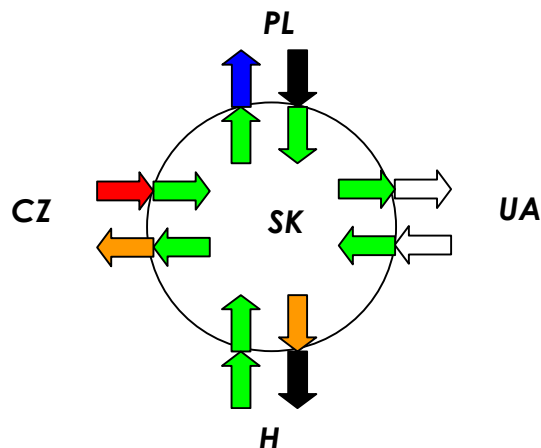

Due to new legal framework it was possible to start in the half of 2003 with yearly and monthly auctioning mechanism at the Slovak - Czech profile. At the end of 2003 also auctioning mechanism has started also at Slovak - Hungarian border profile. Auctioning offices were established in Slovakia and Czech Republic.

I Main disturbances

• The most significant event occurred in the year 2003 is the national black-out on September 28th. A brief description of main events follows:

- 03:01 Tripping of the 400 kV Mettlen-Lavorgo line in Switzerland.
- 03:25 Tripping of the 380 kV Sils-Soazza line in Switzerland.

The power flow redistribution from Switzerland to the other interconnections caused severe overloads on the French border, namely on the 380 kV double-line Rondissone-Albertville, which had been within the security limits until that time. In a few seconds, the power flow redistribution caused overloads and trippings inducing the separation of Italy from the European power system. This fact gave rise to an internal imbalance between electricity demand and supply of 6,700 MW, due to the sum of the total capacity imported until that time from the northern border and of an export towards the portion of the Swiss grid that remained disconnected from the European system.

- 03:28 The frequency on the Italian network dropped to 47.5 Hz, preceded by automatic load shedding and the loss of some power plants. The latter loss made automatic load shedding (of pumping-storage units and loads) ineffective. With the exception of the network in Sardinia and some limited load islands in the peninsula, the whole Italian power system reached a state of black-out.

More details and a press release are available on UCTE web site at www.ucte.org.

- Very high temperatures were recorded on summer in Italy, with consequent increase of the demand and then of the real and reactive power flows on the network. In this context, emergency procedures, intended first of all to control voltages, were performed.
- On December 10th, the maximum peak load met the value of 53400 MW at 5 p.m.. This value represents the historical maximum.
- On July 23rd, the electric energy consumption reached the value of about 1068 GWh, this is the historical maximum

Main congestion

| | | |
|-----|-----|----------|
| I | F | 0 |
| F | I | 5 |
| I | CH | 0 Su/A |
| CH | I | 2 Ay/Ni |
| I | A | 0 |
| A | I | 1 A/Sp D |
| I | GR | 0 |
| GR | I | 0 |
| I | SLO | 0 |
| SLO | I | 0 |

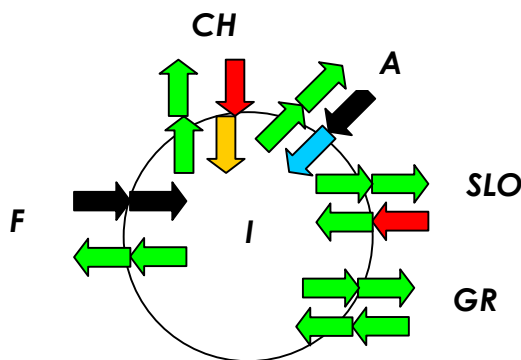

SLO Main disturbances:

Two events were noticeable :

- the Outage of the Nuclear Power Plant Krsko on August 27.
- the outage of substation Tumbri (Croatia), that brought up the outage of 4 400 kV line: Tumbri – Krsko 1,2, Tumbri – Hevitz (Hungary), Tumbri – Melina. The interconnection lines between Austria and Czech Republic were disconnected because of the large amounts of the power flows from Czech Republic to Austria on these interconnection lines. The congestion were observed also on the internal Hungarian and Austrian lines and on the interconnection lines between Hungary and Austria.

On September 28th , the Italian black out did not have a significant influence on the Slovenian network.

Main congestion:

No internal congestion are observed on the Slovenian internal network. Bottlenecks are mostly on the interconnection lines from Austria, and to Italy. It is to be noticed that so far, pro-rata (50/50%) is used for the capacity allocation. Starting on July, 1st 2004, explicit and implicit auctions will be used on the borders with Austria and Italy.

| | | |
|-----|-----|----------|
| A | SLO | 4/A,W,Su |
| SLO | A | 0/N |
| I | SLO | 0/N |
| SLO | I | 4/A,W,Su |
| HR | SLO | 0 |
| SLO | HR | 0 |

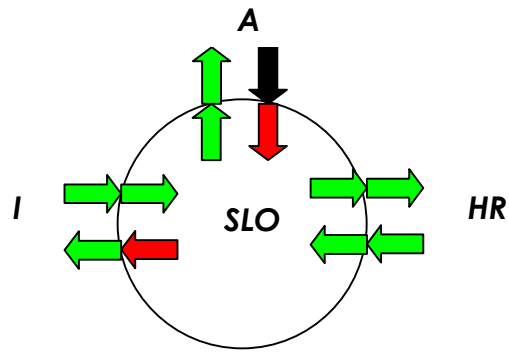

HR Main developments:
 Substation 400/110 kV Ernestinovo, damaged during the war, as well as a part of 110 kV lines and 110 kV facilities in Slavonian region (eastern part of Croatia) were reconstructed. There are no new international tie-lines. Existing tie-line Meuri - Prijedor (220 kV), damaged during the war, was reconstructed and put into operation on May 6th, 2003. This tie-line has a direct effect upon increase of NTC value between Croatia and Bosnia and Herzegovina. There are no new national lines. Existing line Graac - Liki Osik (110 kV), damaged during the war, was reconstructed and put into operation in summer of 2003.

Main disturbances:
 A few significant events occurred in Croatian network during the year 2003. First one took place on January 12th at 16:44 (CET). Because of storm and cold weather with lot of ice on overhead lines, several outages occurred. This caused loss of supply for all consumers in Dalmatia. Dalmatian region was completely cut from Bosnia and Herzegovina and from northern part of Croatia. The blackout lasted till 20:20. About 1600 MWh was not delivered to the consumers. The second event occurred on January 22nd in 400/110 kV substation Tumbri, where the 110 kV Zdenina line breaker tripped because of failure. It caused partially breakdown of transmission system in Zagreb region. The blackout lasted from 8:20 till 11:30 (CET). About 1600 MWh was not delivered to consumers. The third event happened on May 15th when Dalmatian region was once again out of supply. It was caused by disturbance in Bosnian transmission network, which spread into Croatian system. The blackout lasted from 11:07 till 12:06 (CET). About 300 MWh was not delivered to consumers. One serious event took place in 400/110 kV substation Tumbri. Because of outage of generating unit in NPP Krško, the failure spread to substation Tumbri. All lines and transformers on 400kV bus bars tripped out of operation. Fortunately, there was no disconnection of supply. The main reason for breakers tripping was a hidden protection from breakers' failure in substation Tumbri.

Main congestion

| | | |
|-----|-----|---|
| H | HR | 0 |
| HR | H | 0 |
| SLO | HR | 0 |
| HR | SLO | 0 |
| BiH | HR | 0 |
| HR | BiH | 0 |

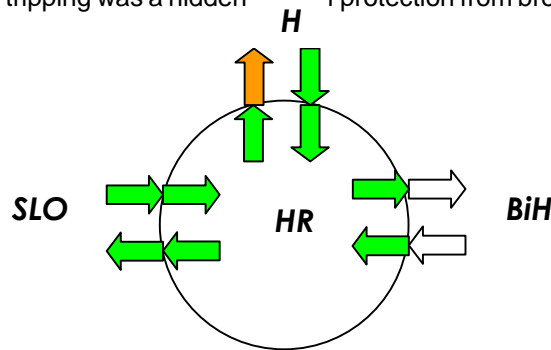

National network:

Transmission lines Mraclin - Tumbri (110 kV) appear as bottleneck on national network in periods of lower production of TPPs, especially of TPP Sisak. The situation is usually resolved by raising and redispatching of generation (especially of TPPs), particularly within region of Zagreb (north-west part of Croatian system).

H Main disturbances:
 On the 13th of January 2003, power accounting for more than 1300 MW (about 25 % of national generation) was lost. The generation outages were mainly caused by fuel problems owing to the extremely low outside temperature that fell below -25°C at some sites. Load shedding was ordered in order to restore the power balance of the Hungarian power system. In sum, energy of 342.9 MWh affecting 6 % of the consumption was not supplied for 2 hours at the longest.

Main congestion:

| | | |
|-------|-------|--------|
| SK | H | 5/AY/A |
| H | SK | 0 |
| A | H | 5/AY/A |
| H | A | 0 |
| HR | H | 3/AY/A |
| H | HR | 0 |
| BI-UA | H | 0 |
| H | BI-UA | - |
| RO | H | - |
| H | RO | 0 |
| SCG | H | - |
| H | SCG | 0 |

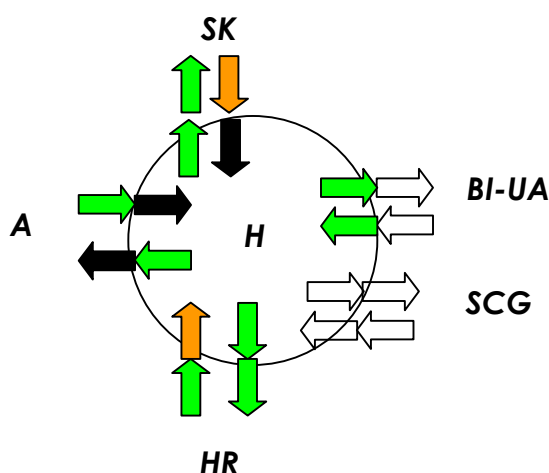

SCG Main congestion:

Congestion occur at the SCG borders towards MK, AL and with BiH in both directions, but there are still no allocation mechanisms at these borders. Congestion Management is performed operationally, in joint efforts of neighbouring TSOs, not on market-based principles. The establishment of capacity allocation and market-based CM mechanisms are in elaboration.

| From: | To: | Description | Season | Corrective measures |
|-------|-------|--|-------------------------------|---|
| SCG | BiH | Overloading of 110 kV network in Zvornik area, when TPP Ugljevik is out of operation | Periodically, during all year | Redispatching of the generation, topology changes |
| BiH | SCG | Failure of OHL 220 kV Visegrad-Pozega cause an overloading of OHL 110 kV Visegrad-Potpec | Periodically, during all year | Decrease of production in HPP Visegrad (BiH) |
| SCG | AL | In case of separation of Albanian system in two radial areas (north and south), n-1 in EPCG and in south EPS is not fulfilled. | Periodically, during all year | Redispatching of the generation, topology changes |
| SCG | FYROM | The tripping of 400 kV Kosovo B-Skopje, Nis-Kosovo B during the large imports of (GR+AL+FYROM+IT) can cause serious disturbances | Periodically, during all year | Redispatching of the generation, topology changes |

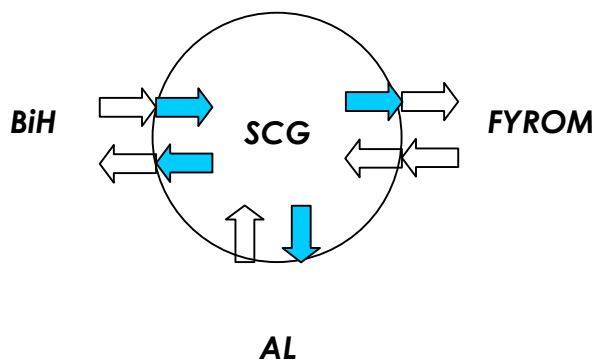

RO Main developments:

The new investments will lead to an increase of power evacuation capacity for the hydro power plant Portile de Fier with a 1150MW net generation capacity, and an increased supply security for consumers in Constanta area.

Main disturbances:

There were no disturbances to threaten the security of the system as a whole or of large system areas. There were only local disturbances affecting a small number of consumers.

Main congestion:

Occasionally congestion may appear in the northern area of the system, at peak load hours in the months December to February, and are solved by generation dispatch and extra meshing of 110kV network.

| | | |
|-----|-----|---|
| RO | BG | 0 |
| BG | RO | 0 |
| RO | SCG | 0 |
| SCG | RO | 0 |

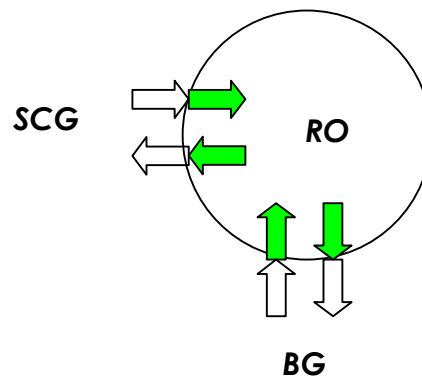

BI-UA Interconnection and management of the congestion:

The trade on the interconnection is monopolised. Pro-rata is used for capacity allocation and congestion management.

GR Main disturbances:

A series of disturbances marked the operation of the Hellenic system:

1. 0408/12.1.03 CET A series of successive trips in 150kV lines till 0652/12.1.03 caused by storm in Thrace area, resulted in the interruption of the supply for some minutes each time in the s/s Xanthi, Komotini, Alexandroupoli and Provatonas.
2. 0855/3.6.03 CET During an isolation in EHT Thessalonica a fire at a bus bar and the necessary operations to protect the stuff of s/s provoked the isolation of Thrace area from the second synchronous zone and the trip of Komotini thermal power plant (420MW) because of over speed. After the plant trip a fall on the frequency caused a load shedding of about 30MW.
3. 1300/18.6.03 CET A malfunction of the protection in a Distribution s/s in the Athens area after a damage at an underground cable during an excavation resulted in the disconnection of a total load of about 200MW for about 23min and the trip of a gas power unit (150MW).
4. 0356/6.10.03 CET An isolator jumping of a circuit breaker and the operation of differential protection at the EHT Pallini in the Athens area because of the high humidity caused the interruption of supply at s/s Spata, Markopoulo, at two transformers of the EHT Pallini and at two distribution s/s (total load about 350MW). The interruption of the supply lasted from 23min till 1 hour and 3min.
5. 1637/13.10.03 CET Isolation of the systems of HTSO, ESM (FYROM) and south part of KESH (Albania) from the second synchronous zone after a trip of the interconnection line Thessaloniki (HTSO) - Blagoevgrad (NEK) because of the damage of the overhead ground wire. At this time the above systems were connected with the rest second synchronous zone only with the tripped line because of maintenance works at the line Kosovo B – Skopje (FYROM) and the separation of Albanian system into two parts. The fault resulted in the drop of frequency at about 49.40Hz.

Main congestion:

Interconnection and management of the congestion

Interconnection is liberalised. There is an explicit auction for capacity allocation which takes place once a year in import direction. The price for the capacity auction (auction once a year) is 1000 euros/MW-year for 2004. Concerning the interconnection between Greece and Italy, no congestion has been experienced so far.

| | | |
|-------------|-------------|-----------------|
| AL+FYROM+BG | GR | 2/Ay/P, 0/Ay/Ni |
| GR | AL+FYROM+BG | 0 |
| I | GR | 0 |
| GR | I | 0 |

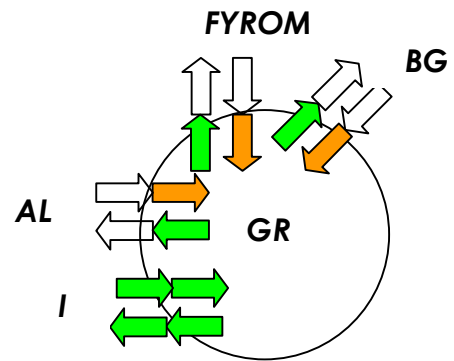

It is to be noticed that the exportable capacity to Italy is lower than the calculated NTC, due to a congestion in Italy.

6. Comments on Market deregulation and Electricity Market Developments

This chapter gives some general information on the opening up of the internal market in terms of implementation of the EU Electricity Directive and market developments occurred in the UCTE countries. The status of electricity market deregulation is not homogeneous over the UCTE countries. The new Electricity Directive draft will probably help to create a real internal European electricity market by the necessary harmonisation.

A Opening process of the market

To realise the 100% opening of the electricity market in Austria a balance group system was implemented on 1 October 2001. The legal base is the Austrian Electricity Act (EiWOG). A balance group is a virtual alliance of market participants within a control area. Market participants are producers, traders and customers which must belong to balance group of their choice. The balance group co-ordinator (settlement agency) calculates the needed balancing energy (deviation of program and physical values) for each balance group and charges it to the balance group. The control area manager is responsible for the load frequency control that means the balance of fed in and consumed power at every moment. In case of deviations the primary and the secondary control try to balance the system automatically. If the deviation can not be balanced by this mechanism, the control area manager calls up additional balance energy according to a merit order which is prepared by the balance group co-ordinator, based on offers for balance energy from producers.

The first important step for the liberalisation was the unbundling which took place on 19 February 1999, i.e. the separation of transmission, distribution and generation. The delivered energy is charged by the supplier based on contracts with a negotiated price for delivered energy. The use of the net is charged by the grid company at a fixed tariff. This ensures a nondiscriminatory charging for the usage of the grid which is a natural monopoly. The Energy Control Ltd. is the regulatory authority and responsible for monitoring, supporting and regulating the Austrian electricity market.

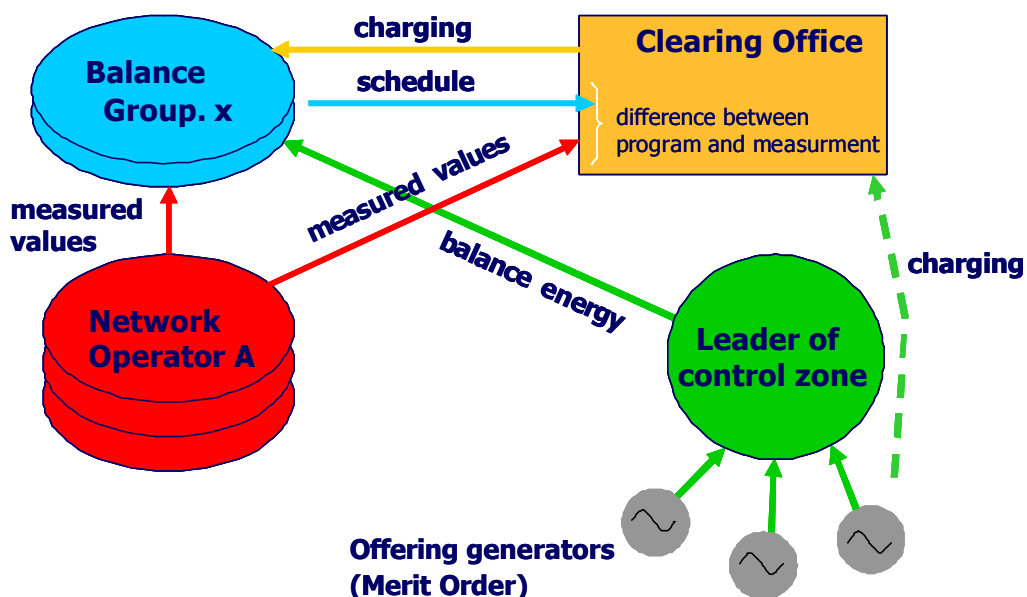

- B** Electricity Market Developments : Elia aims at starting a Belgian spot, day-ahead, power exchange in 2004. Awaited main impact is a greater transparency.
- D** Opening process of the market : International electricity exchanges have further increased, but they compete for limited line capacities (e.g. on the eastern border of Germany) with wind energy which, according to the Kirchhoff laws, is not exclusively transported across German lines. Market-conforming congestion management as it has handled at the relevant German borders, is thus even gaining in importance for Europe as a whole. In 2003, the German Power Exchange EEX in Leipzig traded about 49 TWh in the spot market. As compared to the preceding year, this is an increase of about +50%, and corresponds to approx. 10% of German electricity consumption. The EEX Power Exchange sold 391 TWh in the spot and futures market; hence, it almost doubled the trade volume as compared to the year 2002.
A regulatory body will be institutionalised in July 2004 to replace the system of the Associations' Agreement on network access. To date, the missions of this regulatory authority have not been determined yet in detail. So we assume that the electricity market in Germany will continue to function on the basis of the Associations' Agreement, all the more since the German scheme of negotiated network access has been explicitly provided for in the amended EU Internal Electricity Market Directive. Besides, the instrument of the electricity industry's self-regulation represented by the Associations' Agreement has proven to be successful as it enabled the swift and complete opening-up of the German electricity market. Therefore, the refinement of the current Associations' Agreement II+ is being pursued.
Energy policy: The law concerning the primacy of renewable energies and the Cogeneration Act, decided three years ago, entail an increased development of wind power and secure the operation of existing cogeneration plants.
- F** **Electricity Market Developments:** on April the 1st, the balancing mechanism has started in France. Thus market actors (producers, consumers or traders) who subscribe to the mechanism furnish balancing offers which allow RTE to balance production and consumption and to deal with congestion on the grid. The mechanism due to the opening of the electricity market provides a reference price which is used to settle of the imbalances of the balance scheduling service in France. In 2003 POWERNEXT, the French power-exchange has traded 7.5 TWh; this represents an increase of about 190% compared to the previous year.
Opening process of the market: the new law voted in January opens the market on the 1st of July to every customers except households. This represents 3.7 millions customers and 70% of the electricity market.
- GR** **Electricity Market Developments:** the new participants of the market are supplier authorised to sell electricity to final consumers in Greece. They import electrical energy through the interconnections in order to supply eligible customers. There are also eligible customers who import electrical energy for their own use.
In the context of the new Law 3175/2003 which imposes changes at the structure of the electricity market, the Grid Code and the Power Exchange Code will give the details concerning the operation of the new market. The main characteristics of the new market are the following:
A day ahead market has been introduced. The market is cleared at the day ahead SMP. The TSO is actually responsible for the balance between production and demand. The definition of the imbalances has changed. The imbalances are settled at the imbalance SMP. The method for the calculation of the market prices is under reconsideration.
The System Adequacy in the future is ensured through a new mechanism called "Contracts for Capacity Availability"- an obligation for the suppliers to be able to meet demand of their customers and incentive for the stakeholders to start the construction of their power plants.
Opening process of the market:
- On 1.7.2004, all of the consumers connected to the mainland interconnected system other than householders become eligible customers
 - On 1.7.2007 all of the consumers connected to the mainland interconnected system will become eligible customers.
- SLO** **Access to the grid:** explicit and implicit auctions are expected from July 1st, 2004 on the borders between Slovenia and Austria and Slovenia and Italy.
Energy Policy
Environmental requirements: in the national energy plan, the wind energy is foreseen to amount a total capacity around 200 MW in the next 10 years.

HR **Opening process of the market:** Electricity market in Croatia was opened at the end of the year in amount of 10% of total Croatian consumption. Threshold for consumers to become eligible is annual consumption larger than 40 GWh. At the moment only 15 big customers fulfil this condition. The Market rules are in force since December of year 2003.

L **Opening process of the market:** the opening of the market is foreseen by the actual law of 25th July 2000. To be in coherence with the new EU directive, a new law is in preparation.

Opening process was given in several thresholds.

- 1st threshold by February 19th 1999; consumer >100 GWh; distributors > 800 GWh
- 2nd threshold by 1st January 2001; consumer >20 GWh; distributors > 800 GWh
- 3rd threshold by 1st January 2003; consumer > 9 GWh; distributors > 90 GWh

The new law will specify that by 1st July 2004 all non domestic clients will be eligible 100% opening will be at least by 1st January 2007 but the new law may even specify an earlier date for this opening.

NL **Electricity Market Developments** in the first week of August, in the period of code red with cooling water restrictions, very high prices, up to 1800/MWh, occurred at the APX spot market. It was observed that some industries sold back their nominations to the market and thus lowered the load, proving that the market is able to react in an adequate way.

Opening process of the market

The last stage of the opening of the market for the group of small consumers, which was foreseen for the 1st of January of 2004 has been deferred for political and organisational reasons. It has been decided to start with it at the first of July, 2004.

P **Opening process of the market**

The clients of the independent system represented in 2003 about 10% of the total consumption.

CH **Electricity Market Developments**

The Swiss Utilities are very active on the international markets. The SWEP (Swiss Electricity Power) index shows a trend to higher prices and more frequent peaks of very high prices.

Energy policy

Parliament approved the new Nuclear Energy Act on 21 March 2003, and the referendum deadline expired unused on 4 September 2003. The Federal Council will not be able to bring the new Act into effect before the beginning of 2005 since a variety of legislative tools still need to be prepared:

The new Nuclear Energy Ordinance, incorporating amendments to existing ordinances (e.g. concerning protection against radiation) Amendment to the Energy Ordinance in line with the simultaneous amendment to the Energy Act (electricity labelling, remuneration of additional costs associated with feeding of electricity from renewable energy sources into the network)

New ordinances in the area of nuclear energy. Various provisions of the Nuclear Energy Act need to be fine-tuned in the Nuclear Energy Ordinance, and new regulations need to be incorporated (e.g. governing nuclear goods, the operation and decommissioning of nuclear facilities, and the disposal of radioactive waste). The consultation procedures concerning the amendments to the Energy Ordinance and the new Nuclear Energy Ordinance are scheduled for the first and second quarters of 2004 respectively. The Federal Council expects to be able to bring the Nuclear Energy Act and Nuclear Energy Ordinance into effect on 1 January 2005, and hopes to bring the amendments to the Energy Ordinance into effect on 1 October 2004.

Opening process of the market

Following rejection of the EML (Electricity Market Law) on 22 September 2002, the question arises as to how the Swiss electricity industry should be organised. Subsequent to the referendum on the EML in autumn 2002, several (Parliamentary initiatives) were submitted on the subject of the electricity market.

The DETEC (Federal Department of Energy, Transport, Environment and Communication) appointed an expert commission in March 2003. Its purpose is to lay down the basic form the new electricity industry structure should take with the help of the support groups (ELWO expert commission and support groups) by early 2004. The draft legislation is intended to be submitted early for formal consultation, that is in 2004.

CZ Opening process of the market

Since January 2002 the electricity market has been opened for all consumers with consumption > 9 MWh/year/site.

H Opening process of the market

In the first stage of market opening, from 1 January 2003, the customers of yearly consumption higher than 6.5 GWh can – depending on their own decision – become eligible ones. By the end of December 2003, 222 customers (about 33% of the power market) made registration at the Hungarian Energy Office, of which actually 88 customers (about 18% of the power market) entered into the open market.

Pursuant to the Directive 2003/54/EC, from 1 July 2004 all customers except household customers will be eligible, from 1 July 2007 also the household customers will be eligible, i.e. 100% of the market will be open.

PL Energy Policy

With the aim of the full implementation of the new IEM Directive, the legislation process of adopting the Polish Energy Law Act and its secondary legislation to the requirements of the Directive 2003/54/EC is under way.

Opening process of the market

In May 2003 a secondary legislation to the Energy Law concerning the obligation to purchase electricity and heat from renewable energy sources and electricity generated in combined heat and power units, was amended. The modification combines details of calculation of RES shares and technical specifications of the energy sources. In 2004 this purchase obligation amounts to 2.85% in total annual sale of electricity of the specific energy company. More amendments in the law in relation to RES are expected in 2004. Draft law on the long-term contracts is now under the legislation process. This draft law provides for dissolution of all contracts in return for compensation to eligible generation companies. Consolidation of distribution companies and some of generation companies is now a characteristic trend in the restructuring of the Polish power market.

According to the Polish Energy Law, at the day of Poland's accession to the EU, the opening of the electricity market will be extended to electricity generated in the EU Member States. The regulated TPA has been introduced consequently. The Ordinance of the Minister of Economy (amended on 20 January 2003) on the schedule for acquisition of rights to use transmission services by customers provides for gradual opening of the Polish power market. On 1st January 2002 all customers with total annual purchase of electricity of more than 10 GWh in the previous year acquired that right. Customers with total annual purchase of electricity of more than 1 GWh in 2003 acquired that right from 1 January 2004. The other customers will be eligible from 1 January 2006.

SK Opening process of the market

At the end of 2003 a completely new energy legal framework was drafted under leadership of Ministry of Economy. The framework implements all rules resulting from EC Directives and Decisions adopted by EU in June 2003 concerning energy market and access to the network.

Opening scheme for electricity market is following:

- Since 1st January 2002 – customers with consumption no less than 100 GWh per year
- Since 1st January 2003 – customers with consumption no less than 40 GWh per year
- Since 1st January 2004 – customers with consumption no less than 20 GWh per year
- Since 1st January 2005 – customers with consumption higher than 0 GWh per year

The influence of opening the electricity market on the electricity price in particular periods will be evaluated later, since a new rate structure has been valid since 1st of January 2003.

The Slovenská elektrizačná prenosová sústava - SEPS mission is to ensure electricity transmission from the main producer, as well as electricity imports, exports, and transits via the Slovak territory. The process of liberalisation of electricity was in progress in 2003. The Regulatory Authority issued a number of decisions related to the regulation of electricity supplies prices for protected customers, and electricity distribution for eligible customers, as well as rates for transmission and system services.

The basic legislative standard in the power generation industry is the Act No. 70/1998 (on power engineering), and the Act No. 276/2002 (on regulation in network industries). The acts are followed by the Decree of the Ministry of Economy (No. 548/2002 and 549/2002 Coll.), which set out rules of the electricity market opening, as well as conditions and rules for electricity transmission and distribution in the liberalised environment.

Linked to the legislation adopted, SEPS issued and updated following documents which were approved by

Regulatory Authority:

- Grid Code
- Dispatch Order for Control of the Power System of the Slovak Republic
- Trading Code
- Commercial conditions of SEPS

All the above documents are available on the web-site www.sepsas.sk.

BiH Opening process of the market

Laws are currently under preparation.

RO Opening process of the market

The Romanian Electricity Market developed taking into account the significant changes in industry structure (unbundling and development of competition) and related commercial relationships. Within the liberalized electricity market Transelectrica assures the safety and reliable operation of the Power System and the quality of the delivered electric energy. The developing of competitive market mechanisms is fully consistent with the necessity to comply with the energy sector requirements for Romania's accession to the European Union and with the related efforts of the power industry to become competitive in the wake of the liberalization of the European Energy Market.

| Country | Date of beginning of deregulation process | 1st threshold | 2nd threshold | Other threshold |
|---------|---|---|--|--|
| RO | Government Emergency Ordinance no.68/1998; in July 2003 the Romanian Parliament adopted a comprehensive Energy Law no.318/2003 including all former changes | Government decision (GD) no.122/2000:- the competitive market is up to 10%; | GD no.982/2000 -15%; GD no.1272/2001-25% GD no. 48/31.01.02-33% GD no.1563/18.12.03-40% | The market will be open at 80% by 2005 and 100% by 2007. |

Energy policy

In July 2003 was adopted the "Energy Law", no. 318, that includes a relevant part of the European Union legislation and of the former Romanian Government Decisions regarding the restructuring process of power industry.

The secondary legislation consists of regulations issued by the Romanian Electricity and Heat Regulatory Authority (ANRE) and includes:

1. Licenses and authorisations;
2. Technical Transmission Grid Code;
3. Technical Distribution Grid Code;
4. Wholesale Electricity Market Commercial Code;
5. Tariffs and tariff methodology;
6. Framework contracts for trading arrangements.

All regulations were drafted on the basis of laws with a view to setting out correct, transparent and market-driven relationships among market participants. Another document that includes important decisions related to energy policy is the "Road Map for Energy Field in Romania", issued by the Ministry of Industry and Resources and approved with the Government Decision no. 890/29 July 2003.

FY ROM Opening process of the market

Regarding provisions of the Athens memorandum, Macedonia is doing very serious efforts to create independent institutions for policy, regulation and system operation. The Energy Regulatory Commission was established in July 2003, and the New Electricity law was adopted by the Government.

The new law for unbundling of the Electric Power Company of Macedonia is prepared. ESM will be divided in three parts: Generation, Transmission and Distribution.

So, the energy sector of Macedonia is doing very serious efforts for accession to the Regional Electricity Market in South East Europe and its integration into the European Union's Internal Electricity Market.

7. Additional remarks

- D** Apart from the discussion about the future regulation to implement the EU Electricity Directive of June 2003, the electricity industry's priority subject was the fast development of renewable energies as a result of the promotion pursuant to the Renewable Energy Sources Act (German abbreviation: EEG), particularly of wind energy. The Energy Industry Act (German abbreviation: EnWG) had to be amended in 2003 with a view to completely implementing the EU Gas Directive. In this context, intensive political discussions were held about the electricity market liberalisation, particularly with regard to the legal embodiment of the Associations' Agreement II+ (German abbreviation: VV II+) and of its calculation guide about the detailed assumptions for the calculation of network charges. On the one hand, this discussion led to a political decision in March 2003 to introduce in 2004 state regulation of the methodology for the calculation of network charges and, on the other hand, to the embodiment of the Associations' Agreement II+ in the German Energy Industry Act in May 2003, based on the assumption of good professional practice. The latter principle led to a temporarily enhanced legal security with regard to the amount of network charges. The Monitoring Report of the German Federal Ministry of Economics and Labour issued at the end of August 2003 assessed the experience gained with the negotiated system access regime of the Associations' Agreements, and made a proposal on the introduction of state regulation. As a result of the Renewable Energy Sources Act, about 2,600 MW of wind power capacity were newly installed in 2003, so that more than 14,000 MW were installed at the end of the year. Thus, Germany ranks first world-wide in this respect. The transport of wind energy from Northern Germany (wind power is strongest on the shore or at sea) requires already network extensions at the high and extra-high voltage levels, with new circuits covering presumably a distance of much more than 1.000 km. Much more important in financial terms is the additional control and balancing energy which is required due to fluctuations in wind conditions. While feed-in fluctuations which were caused until about three years ago by some thousand MW of wind power, reached the same order of magnitude as load fluctuations or control demand through power station failures, the wind power capacity existing today has led to a new order of magnitude of fluctuations that need to be balanced. There are intensive discussions going on (also in the context of the debates on the amendment of the Renewable Energy Sources Act) about the volume of additional costs, and on the way of covering these costs in the best possible way.
- GR** The use of the natural gas is the main fuel in the new power plants.
- SLO** High prices in Italy are the main external market influence, as the exports from East part to Italy are high.
- NL** The values of this retrospect 2002 are national values or were appropriate professional based best estimates.
- CH** The latest energy scenarios indicate that if current energy policies are continued, energy consumption will increase heavily, particularly in the sectors of motor fuels, industrial processes and electrical energy. This would mean that the CO₂ objectives specified under SwissEnergy, and also those laid down in the CO₂ Law and in international climate conventions, cannot be achieved. To fulfil these goals, efforts must be redoubled in all areas of consumption.
- PL** The existing surplus of generating capacity as well as adequate transmission capacities within Poland allowed to cover the internal electricity demand without periods of extraordinary high prices on Polish Power Exchange or balancing market last year. The increase of exchanges was noticed, especially the export to Sweden in 2003.
- SK** A lot of other changes and challenges occurred for SEPS in 2003. With regard to new legislation SEPS signed new contracts with its partners especially regional energy companies and direct eligible consumers under new liberalised energy market conditions. Contracts include transmission services, system services and accounting deviations. For the first time in history SEPS was purchasing most of ancillary services from the dominant producer Slovenské elektrárne, a.s. All these contracts were closed under conditions comprised in Trading code and Grid Code of SEPS.
- BiH** Resynchronisation with the I and II UCTE zones is expected by mid 2004.

RO CN Transelectrica SA is the administrator of the electric market, through its legal subsidiary – the market operator OPCOM. OPCOM plays the role of electric market administrator, as stated in the primary and secondary legislation in force, providing an organising, viable and efficient framework for the commercial transactions traded within the wholesale power market, under the conditions of consistency, fairness, objectivity, independence, equidistance, transparency and nondiscrimination. As an early recognition of its efforts, OPCOM has been accepted as full member of the International Power Exchanges Association – APEX starting the October 1st, 2001. The Romanian wholesale electric market, which started on August 1st, 2000, is aimed for electricity and ancillary services trade among market participants and is made up by two components:

- the regulated market;
- the competitive market.

1. The regulated market is meant for electricity and ancillary services trade on regulated contract basis (with regulated prices and regulated and usually firm quantities). The contracts concluded on the regulated market are:
 - portfolio contracts (firm quantities and regulated prices);
 - contracts for electricity in co-generation (quantities and regulated prices)
 - PPA contracts (long term contracts with regulated prices) - the “must run-must take” contract for SN Nuclearelectrica SA concluded for the whole output of the power plant;
 - ancillary services contracts (firm quantities, established by the System Operator, and regulated prices);
 - transmission contracts (regulated tariffs).
2. The competitive market is meant for electricity trade through bilateral contracts (firm quantities and negotiated prices) and by auction on the spot market (bulk transactions based on bids from producers). The following contracts are concluded on the competitive market:
 - bilateral contracts between internal producers/suppliers with eligible consumers or with other suppliers for the eligible consumers’ consumption;
 - import contracts of the producers (for the unbalances that arise in portfolio contracts) and the suppliers import contracts;
 - export contracts;
 - negotiated contracts concluded by independent producers and self-producers, others than the owners of portfolio contracts;
 - transactions on spot market at the System Marginal Price.

At present OPCOM administrates about 200 contracts per month. OPCOM aims at becoming an attractive and efficient trading environment for all the agents interested to be actively involved in the domestic and regional energy market as well, by developing the market instruments required by every stage of the Romanian wholesale power market progress and at permanently contributing to the improvement of the legislative framework governing the electricity trade. Transelectrica is in charge of substantiating the portfolio selling/purchasing contracts established between some generation companies and supply companies. This is carried out by means of a computer simulation model, approved by the ANRE, and consists in determining the hourly electricity generation of each company according to the merit order of its units and in shaping the regulated prices for each base settlement period of electricity load curve. The tariffs for the regulated market, corresponding to the captive consumers, are established by the regulator. Eligible consumers, power suppliers and even Electrica have the opportunity to trade electricity on the competitive market, where prices are directly negotiated according to bilateral contracts or settled on the spot market. Both the existing and the new participants on the electric market are equally treated on a transparent and non-discriminatory basis, which also includes the regulated access to the transmission and distribution networks. In this respect, connection to the grids is a compulsory public service.

Participants to the market

Producers: Main producers (7): Termoelectrica, Hidroelectrica, Nuclearelectrica, TPP’s Deva, TPP’s Rovinari, TPP’s Turceni, TPP’s Bucuresti, as well as other independent producers (28) and self producers (8).

Buyers:

Suppliers and/or generators(51): Main Suppliers: Electrica and its 8 subsidiary companies, Termoelectrica, Hidroelectrica, Nuclearelectrica, Romenergo, Romelectro, UNICOM, ALRO, GRIVCO. Eligible Consumers (49) Transmission System Operator (for transmission and ancillary services at regulated tariffs).

BI-UA All data in power balance are given in gross values. In energy balance data of Burshtyn TPP are given in net values, data of hydro PS and industrial TPS are given in gross values (generation of industrial TPS is nearly 7% of total generation).

UCTE System Adequacy Retrospect 2003, Power Data
net values at the reference time 11:00 a.m. on the 3rd Wednesday every month

Table A/1

Values in GW

| | Jan. | Feb. | March | April | May | June | July | Aug. | Sept. | Oct. | Nov. | Dec. |
|--|--------------|--------------|--------------|--------------|--------------|--------------|--------------|--------------|--------------|--------------|--------------|--------------|
| National generating capacity | | | | | | | | | | | | |
| 1. Hydro power stations | 129.4 | 129.4 | 129.4 | 129.4 | 129.5 | 129.5 | 129.8 | 129.8 | 129.8 | 129.8 | 129.8 | 129.9 |
| 2. Nuclear power stations | 112.8 | 112.8 | 112.8 | 112.8 | 113.7 | 113.7 | 113.7 | 113.7 | 113.7 | 113.7 | 113.1 | 113.1 |
| 3. Conventional thermal power stations | 294.8 | 295.2 | 295.2 | 295.8 | 295.9 | 296.8 | 297.1 | 297.2 | 298.0 | 297.8 | 298.1 | 298.4 |
| 4. Renewable energy sources | 21.8 | 22.1 | 22.4 | 22.7 | 22.9 | 23.3 | 23.6 | 23.9 | 24.2 | 24.6 | 25.0 | 25.7 |
| 5. Not clearly identifiable energy sources | 1.9 | 1.9 | 1.9 | 1.9 | 1.9 | 1.9 | 1.9 | 1.9 | 1.9 | 1.9 | 1.9 | 1.9 |
| 6. National generating capacity (6 = 1+2+3+4+5) | 560.6 | 561.4 | 561.7 | 562.6 | 563.9 | 565.1 | 566.1 | 566.5 | 567.5 | 567.7 | 567.9 | 569.1 |
| 7. Non-usable capacity | 84.8 | 87.6 | 98.6 | 103.5 | 102.0 | 106.9 | 111.4 | 111.9 | 108.1 | 97.5 | 95.3 | 92.5 |
| 8. Overhauls (thermal power stations) | 15.7 | 20.1 | 29.6 | 38.1 | 48.8 | 47.6 | 46.1 | 44.8 | 47.6 | 37.9 | 23.8 | 11.8 |
| 9. Outages (thermal power stations) | 14.3 | 14.1 | 19.3 | 20.7 | 24.1 | 21.5 | 22.2 | 30.2 | 18.5 | 20.0 | 18.6 | 18.8 |
| 10. System services reserve | 32.0 | 29.0 | 30.1 | 29.6 | 27.6 | 27.9 | 26.3 | 27.5 | 27.0 | 29.8 | 31.5 | 32.4 |
| 11. Guaranteed capacity (11 = 6-(7+8+9+10)) | 413.8 | 410.6 | 385.0 | 371.4 | 362.0 | 362.2 | 360.8 | 353.0 | 367.2 | 383.2 | 399.3 | 414.2 |
| 12. Load | 353.7 | 355.5 | 313.5 | 300.7 | 300.0 | 307.4 | 307.0 | 277.7 | 298.5 | 310.5 | 328.8 | 348.2 |
| 13. Margin against monthly peak load | 27.1 | 13.9 | 29.8 | 38.0 | 15.0 | 20.5 | 21.2 | 37.5 | 23.6 | 39.7 | 29.4 | 29.6 |
| 14. Remaining capacity without exchanges (14 = 11-12) | 60.2 | 55.1 | 71.5 | 70.7 | 62.0 | 54.9 | 53.8 | 75.3 | 68.7 | 72.7 | 70.5 | 66.0 |
| Physical exchanges | | | | | | | | | | | | |
| 15. Import | 35.0 | 33.2 | 34.7 | 35.4 | 35.4 | 38.3 | 31.3 | 32.0 | 33.5 | 36.2 | 41.2 | 37.7 |
| 16. Export | 32.9 | 30.4 | 34.9 | 36.7 | 30.8 | 31.5 | 30.0 | 28.3 | 30.6 | 31.4 | 39.1 | 36.1 |
| 17. Physical exchange balance (17=15-16) | 2.1 | 2.8 | - 0.2 | - 1.3 | 4.6 | 6.9 | 1.4 | 3.7 | 2.6 | 5.2 | 2.1 | 1.6 |
| 18. Remaining capacity with exchange (18=14+17) | 62.3 | 57.9 | 71.3 | 69.4 | 66.6 | 61.7 | 55.2 | 79.0 | 71.3 | 77.9 | 72.6 | 67.7 |

Table B / 1

UCTE System Adequacy Retrospect 2003, Energy Data

Values in TWh

| | B | D | E | F | GR | I | SLO | HR | BiH | FY | SCG | L | NL* | A** | P | CH*** | CZ | H | PL | SK | RO | BG | BI-UA | UCTE | UCTE | |
|--|------|-------|-------|-------|------|-------|------|------|------|-----|------|-----|-------|------|------|-------|-------|------|-------|------|------|------|-------|-----------|---------|------|
| | | | | | | | | | | | | | | | | | | | | | | | | 2002 | | |
| | | | | | | | | | | | | | | | | | | | | | | | | perimeter | | |
| Generation | | | | | | | | | | | | | | | | | | | | | | | | | | |
| 1. Hydro power stations | 1.3 | 25.0 | 43.0 | 60.4 | 5.2 | 43.6 | 2.7 | 4.9 | 4.6 | 1.4 | 10.7 | 1.0 | 0.1 | 32.2 | 15.6 | 36.4 | 1.8 | 0.2 | 3.1 | 3.5 | 13.0 | 2.7 | 0.1 | 312.5 | 292.1 | |
| 2. Nuclear power stations | 45.0 | 156.4 | 59.2 | 420.0 | 0.0 | 0.0 | 5.0 | 0.0 | 0.0 | 0.0 | 0.0 | 0.0 | 3.8 | 0.0 | 0.0 | 26.9 | 24.4 | 10.4 | 0.0 | 16.5 | 4.6 | 16.0 | 0.0 | 788.2 | 767.6 | |
| 3. Conventional thermal power stations | 33.0 | 354.0 | 110.6 | 43.3 | 42.6 | 229.0 | 4.6 | 6.7 | 6.6 | 4.9 | 25.8 | 2.6 | 85.7 | 23.8 | 24.0 | 2.9 | 50.5 | 18.6 | 135.7 | 6.2 | 34.0 | 17.2 | 7.3 | 1269.6 | 12014.6 | |
| 4. Renewable energy sources (of which, wind) | 1.0 | 25.0 | 14.3 | 1.0 | 0.7 | 6.4 | 0.0 | 0.0 | 0.0 | 0.0 | 0.0 | 0.0 | 3.6 | 0.0 | 0.0 | n.a. | 0.0 | 0.1 | 0.3 | 0.0 | 0.0 | 0.3 | 0.0 | 53.8 | 53.8 | |
| | 0.1 | 19.0 | 12.0 | 0.0 | 0.0 | 1.4 | 0.0 | 0.0 | 0.0 | 0.0 | 0.0 | 0.0 | 1.3 | 0.0 | 0.5 | 0.0 | 0.0 | 0.0 | 0.1 | 0.0 | 0.0 | 0.0 | 0.0 | 0.0 | 34.4 | 34.4 |
| 5. Not clearly identifiable energy sources | 0.0 | 0.0 | 0.0 | 0.0 | 0.0 | 0.0 | 0.0 | 0.0 | 0.0 | 0.0 | 0.0 | 0.0 | 0.0 | 3.9 | 3.9 | 0.0 | 0.0 | 2.2 | 0.0 | 2.7 | 0.0 | 0.0 | 0.0 | 8.8 | 8.8 | |
| 6.Total (6 = 1+2+3+4+5) | 80.3 | 560.4 | 227.2 | 524.7 | 48.5 | 279.0 | 12.2 | 11.6 | 11.2 | 6.3 | 36.5 | 3.5 | 93.2 | 59.9 | 40.7 | 66.3 | 76.7 | 31.5 | 139.1 | 28.9 | 51.5 | 36.3 | 7.4 | 2433.0 | 2326.5 | |
| 7. Exchanges (7 = 7a - 7b) | 6.3 | -8.1 | 1.3 | -6.6 | 2.2 | 50.8 | 0.2 | 3.9 | -1.1 | 1.0 | 3.1 | 3.8 | 17.0 | 5.6 | 2.8 | -1.1 | -16.2 | 6.9 | -10.2 | -2.2 | -2.1 | -5.5 | -3.3 | -13.5 | -1.6 | |
| 7a.Import | 14.6 | 45.8 | 9.5 | 6.5 | 4.2 | 51.4 | 4.0 | 8.9 | 2.0 | 1.1 | 6.2 | 6.6 | 20.8 | 19.0 | 5.9 | 30.1 | 10.1 | 14.0 | 5.0 | 8.6 | 1.0 | 1.3 | 1.3 | 277.6 | 272.1 | |
| 7b.Export | 8.3 | 53.8 | 8.3 | 73.1 | 2.1 | 0.5 | 3.8 | 5.0 | 3.1 | 0.1 | 3.1 | 2.8 | 3.8 | 13.4 | 3.1 | 33.2 | 26.3 | 7.1 | 15.1 | 10.8 | 3.0 | 6.8 | 4.6 | 291.2 | 273.7 | |
| 8. Pumped storage | 1.4 | 7.0 | 4.7 | 7.3 | 0.8 | 10.4 | 0.0 | 0.1 | 0.0 | 0.0 | 0.5 | 1.1 | 0.0 | 2.9 | 0.5 | 2.9 | 0.6 | 0.0 | 2.3 | 0.3 | 0.0 | 0.5 | 0.0 | 43.3 | 42.8 | |
| 9. Consumption (9 = 6+7-8)) | 85.2 | 545.3 | 223.7 | 450.8 | 49.8 | 319.5 | 12.4 | 15.4 | 10.1 | 7.2 | 39.1 | 6.1 | 110.2 | 62.6 | 43.0 | 60.3 | 59.9 | 38.4 | 126.7 | 26.4 | 49.4 | 30.4 | 4.1 | 2376.1 | 2282.1 | |

* in monthly statistics, renewable energy sources generation is taken into account as conventional thermal generation

** data for generation and consumption are approx.7TWh higher than monthly data (representativity factor near 100%)

*** import and export of exchanges are not consistent with monthly statistics

Appendix 1 : Transmission system Adequacy, main grid developments

The following tables shows the main grid developments in the different UCTE countries.

Belgium

| Line or Equipment name | Voltage Level | Commissioning Date | Main Characteristics (single or double circuit line, length, AC lines or DC lines,...) |
|------------------------|---------------|--------------------|---|
| Tihange - Avesnes | 380 / 150 kV | 07/11/2003 | Line and cable and Trf 380 / 150 kV 587.2 MVA |

Germany

| Line or Equipment name | Voltage Level | Commissioning Date | Main Characteristics (single or double circuit line, length, AC lines or DC lines,...) |
|--------------------------|---------------|--------------------|---|
| Beerfelden - Großgartach | 220 kV | December 2003 | single circuit, 60 km |
| Wehrendorf - Hanekenfähr | 380 kV | October 2003 | single circuit, 74 km |

Spain

| Line or Equipment name | Voltage Level | Commissioning Date | Main Characteristics (single or double circuit line, length, AC lines or DC lines,...) |
|----------------------------|---------------|--------------------|---|
| Cartelle - Lindoso | 400 kV | October 2003 | AC line 48,47 km; 2 circuits (one is new) |
| Virtus- Herrera | 400 kV | May 2003 | AC line 64,54 km; one circuit |
| Virtus - Güenes | 400 kV | May 2003 | AC line 73,4 km; one circuit |
| Fuentes - Loeches | 400 kV | April 2003 | AC line 67,4 km; one circuit |
| Fuentes - Trillo | 400 kV | April 2003 | AC line 73,3 km; one circuit |
| Arcos - DRodrigo | 400 kV | December 2003 | AC line 68,15 km; one circuit |
| Arcos - Pto Cruz | 400 kV | October 2003 | AC line 114,14 km; one circuit |
| Guandame - Valdecaballeros | 400 kV | December 2003 | AC line 2 circuits (one is new) |
| Litoral - Rocamora | 400 kV | July 2003 | AC line 185,24 km; 2 circuits (one is new) |
| Pto Cruz - Pinar del Rey | 400 kV | October 2003 | AC line 35,14 km; one circuit |
| Pto Cruz - Tarifa | 400 kV | October 2003 | AC line 9,21 km; one circuit |
| Cartelle | 400 / 220 kV | December 2003 | Transformer 600 MVA |
| Almazan | 400 / 132 kV | October 2003 | Transformer 450 MVA |
| Virtus | 400 / 66 kV | June 2003 | Transformer 300 MVA |
| Asomada | 400 / 132 kV | November 2003 | Transformer 300 MVA |
| Fuencarral | 400 / 220 kV | December 2003 | Transformer 600 MVA |

France

| Line or Equipment name | Voltage Level | Commissioning Date | Main Characteristics (single or double circuit line, length, AC lines or DC lines,...) |
|------------------------------|---------------|--------------------------|---|
| Travel Tricastin N°4 and N°5 | 400 kV | January and October 2003 | 39,3 km |
| Chevalet Gavrelle | 400 kV | October 2003 | 25,7 km |
| Boutre Coudon | 225 kV | December 2003 | 63,4 km; upgrading of an existing single circuit 225 kV |

Greece

| Line or Equipment name | Voltage Level | Commissioning Date | Main Characteristics (single or double circuit line, length, AC lines or DC lines,...) |
|--------------------------------------|---------------|--------------------|---|
| EHT s/s Meliti - Achlada | 400 kV | 2003 | |
| Autotransformer in EHT s/s Arachthos | 400 kV | 2003 | 280 MVA |

Italy

| Line or Equipment name | Voltage Level | Commissioning Date | Main Characteristics (single or double circuit line, length, AC lines or DC lines,...) |
|-----------------------------------|---------------|--------------------|---|
| Pieve Abignola - Baggio | 380 kV | 2003 | Single line |
| Pieve Albignola - Castelnuovo | 380 kV | 2003 | Single line |
| Favara - Chiaramonte | 220 kV | 2003 | Single line |
| S.Massenza - Cardano | 220 kV | 2003 | Single line |
| #34 Lines | 150 / 132 kV | 2003 | lines |
| Transformer | 380 / 150 kV | 2003 | Total of 250 MVA |
| Transformer | 380 / 132 kV | 2003 | Total of 1250 MVA |
| Transformer | 220 / 150 kV | 2003 | Total of 410 MVA |
| SS / E | 132 kV | 2003 | 2 substation |
| S / E | 380 kV | 2003 | Station |
| SS / E | 380 kV | 2003 | substation |
| Substation | 150 / 132 kV | 2003 | #23 substation |
| Ferrera Erbognona - Pieve Albign. | 380 kV | 2003 | Single line |
| Ravenna Canale - Enipower RA | 380 kV | 2003 | Single line |

The Netherlands

| Line or Equipment name | Voltage Level | Commissioning Date | Main Characteristics (single or double circuit line, length, AC lines or DC lines,...) |
|--|---------------|--------------------|---|
| Phase shifter Meeden | 380 kV | January 2003 | 1000 MVA |
| Insertion of the formerly 380 kV-line "Conneforde (E.On Netz) - Meeden (TenneT)" in the sub-station Diele. This leads to the new 380 kV lines Conneforde - Diele and Diele - Meeden (TenneT) | 380 kV | February 2003 | |
| Several capacitor banks and shunt-reactors | 380 kV | 4.Quarter 2003 | |

Portugal

| Line or Equipment name | Voltage Level | Commissioning Date | Main Characteristics (single or double circuit line, length, AC lines or DC lines,...) |
|--------------------------------|---------------|--------------------|--|
| TRs at SE of Alto do Mira | 400 / 60 kV | 20th May 2003 | 170 MVA transformer |
| | | 6th June 2003 | 170 MVA transformer |
| New GIS station at Zezere | 150 kV | 11th July 2003 | Gas Insulated switching station |
| AT at SE of Zezere | 220 / 150 kV | 21th November2003 | 120 MVA autotransformer |
| AT at SE of Palmela | 400 / 150 kV | 12th December2003 | 450 MVA autotransformer |
| Fanhoes - Alto do Mira 5 | 400 kV | 20th May 2003 | AC circuit of 18,3 km (double pole) |
| Fanhoes - Alto do Mira 4 | 400 kV | 30th June 2003 | AC circuit of 18,3 km (double pole) |
| Alqueva - Ferreira do Alentejo | 400 kV | 27th October 2003 | AC circuit of 62,2 km (single pole) |
| Sines - Saboia | 150 kV | 9th December2003 | AC circuit of 60,8 and 55,7 km from derivation of old Sines - Tunes 1 line to the new SE of Saboia (train) |

Switzerland

| Line or Equipment name | Voltage Level | Commissioning Date | Main Characteristics (single or double circuit line, length, AC lines or DC lines,...) |
|------------------------|---------------|--------------------|---|
| Goesgen - Mettlen | 380 kV | July 2003 | double circuit, 45 km, AC |

Czech Republic

| Line or Equipment name | Voltage Level | Commissioning Date | Main Characteristics (single or double circuit line, length, AC lines or DC lines,...) |
|---------------------------------------|---------------|--------------------|---|
| Transformer in substation Cechy Stred | 400 / 220 kV | 17th August 2003 | Upgrading of the old transformer(630 MVA) by the new one with capacity 500 MVA |

Hungary

| Line or Equipment name | Voltage Level | Commissioning Date | Main Characteristics (single or double circuit line, length, AC lines or DC lines,...) |
|-------------------------------|----------------------|---------------------------|--|
| Sandorfalfa - Bekescsaba | 400 kV | 27th September 2003 | Single circuit, 92 km |

Poland

| Line or Equipment name | Voltage Level | Commissioning Date | Main Characteristics (single or double circuit line, length, AC lines or DC lines,...) |
|---|----------------------|---------------------------|--|
| 1.Line Dobrzyń (PL) - Albrechtice (CZ) | 400 kV | 10th November 2003 | 132,58 km, single AC |
| 2.line Dobrzyń (PL) - Wielopole (PL) | 400 kV | 10th November 2003 | 120,57 km, single AC |
| Line Pogwizdów (PL) - Darkov (CZ) | 110 kV | 1st September 2003 | n.a. AC line - distribution level |

Romania

| Line or Equipment name | Voltage Level | Commissioning Date | Main Characteristics (single or double circuit line, length, AC lines or DC lines,...) |
|---|----------------------|---------------------------|--|
| Autotransformer- substation Portile Fier I | 400 / 231 kV | 2003 | 500 MVA replace the old 400 MVA autotransformer |
| Transformer - substation Constanta Nord | 400 / 121 kV | 2003 | 250 MVA |

FYROM

| Line or Equipment name | Voltage Level | Commissioning Date | Main Characteristics (single or double circuit line, length, AC lines or DC lines,...) |
|-------------------------------|----------------------|---------------------------|--|
| S / S Skopje 5 | 400 / 110 kV | 23th November 2003 | |

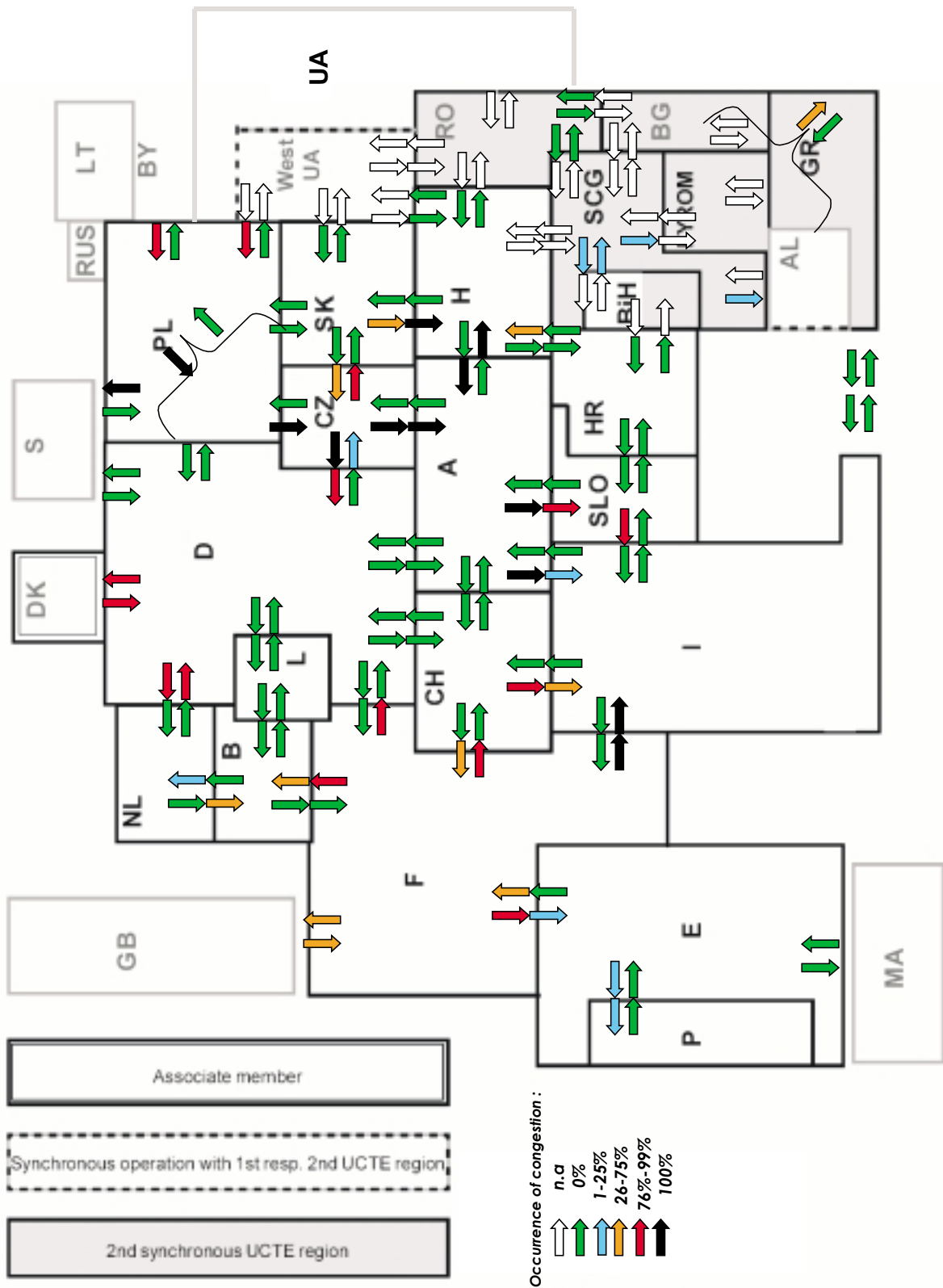

Executive editor: UCTE-Secretariat
15, Boulevard Saint-Michel, 1040 Brussels

Responsible for content: UCTE

Production editor: Vattenfall Europe Information Services

Contact: www.ucte.org
info@ucte.org



Contact

Boulevard Saint-Michel, 15
B-1040 Brussels - Belgium
Tel +3227416940 - Fax +3227416949

info@ucte.org
www.ucte.org