

P1 – Policy 1: Load-Frequency Control and Performance [C]

Chapters

- A. Primary Control
- B. Secondary Control
- C. Tertiary Control
- D. Time Control

Introduction

The GENERATION of power units and CONSUMPTION of loads connected to the UCTE network needs to be controlled and monitored for secure and high-quality operation of the SYNCHRONOUS AREAS. The LOAD-FREQUENCY-CONTROL control, the technical reserves and the corresponding control performances are essential to allow TSOs to perform daily operational business.

Within the UCTE SYNCHRONOUS AREA, the control actions and the reserves are organised in a hierarchical structure with CONTROL AREAS, CONTROL BLOCKS and the SYNCHRONOUS AREA with two CO-ORDINATION CENTERS.(for the principle see Figure 1 below, see also UCTE Pyramid in Policy 2).

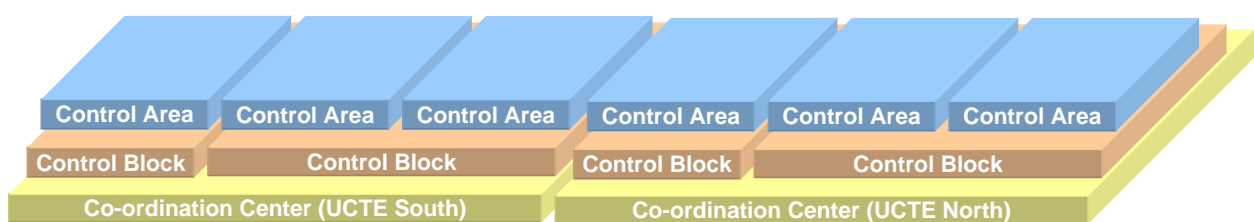

Figure 1: Hierarchical control structure of UCTE SYNCHRONOUS AREA composed of CONTROL AREAS (CA), CONTROL BLOCKS (CB) and CO-ORDINATION CENTERS (CC)

Control actions are performed in different successive steps, each with different characteristics and qualities, and all depending on each other (see figure 2 below):

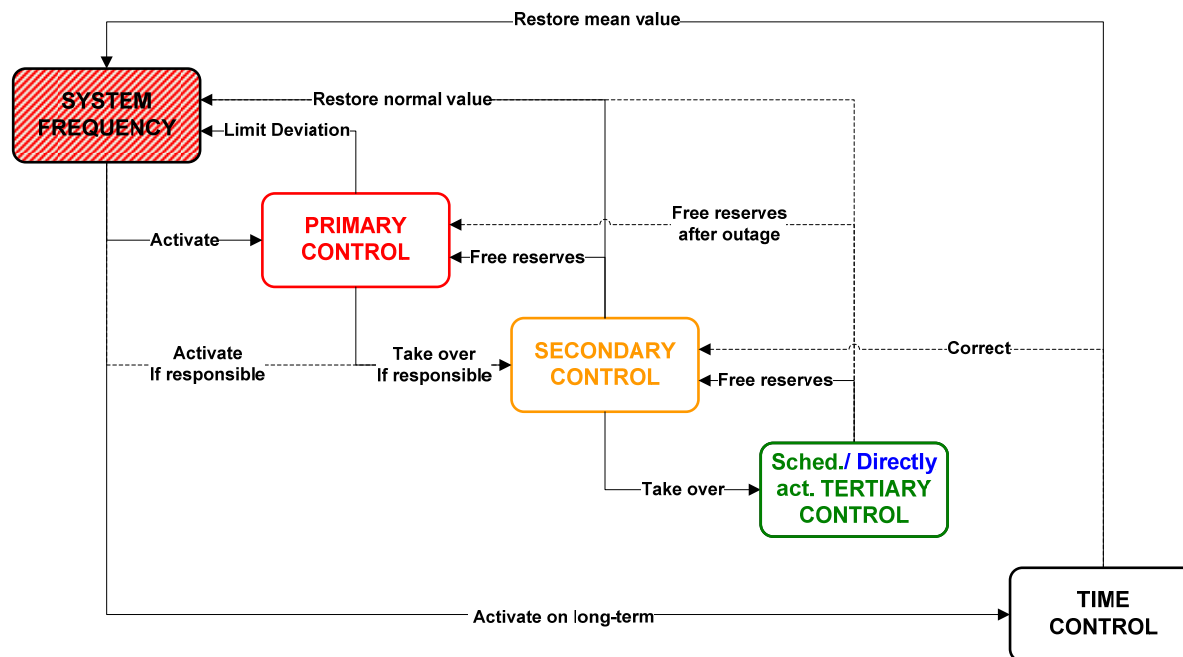

Figure 2: Control scheme and actions starting with the system frequency

- PRIMARY CONTROL (see section ►►P1-A) starts within seconds as a joint action of all parties involved.
- SECONDARY CONTROL (see section ►►P1-B) replaces PRIMARY CONTROL over minutes and is put into action by the responsible parties / TSOs only.
- TERTIARY CONTROL (see subsection ►►P1-C) partially complements and finally replaces SECONDARY CONTROL by re-scheduling generation and is put into action by the responsible parties / TSOs.
- TIME CONTROL (see subsection ►►P1-D) corrects global TIME DEVIATIONS of the SYNCHRONOUS TIME in the long term as a joint action of all parties / TSOs.

On the time axis, the different control reserves cover different time frames. Figure 3 illustrates the principles, how in case of an incident with a large frequency drop (the dotted line beginning before activation of Primary Control shows the principle plot of the frequency deviation) the activation of PRIMARY CONTROL RESERVE (activated within seconds) is followed up by SECONDARY CONTROL RESERVE (activated within minutes) and SECONDARY CONTROL RESERVE is supported and followed up by TERTIARY CONTROL RESERVE.

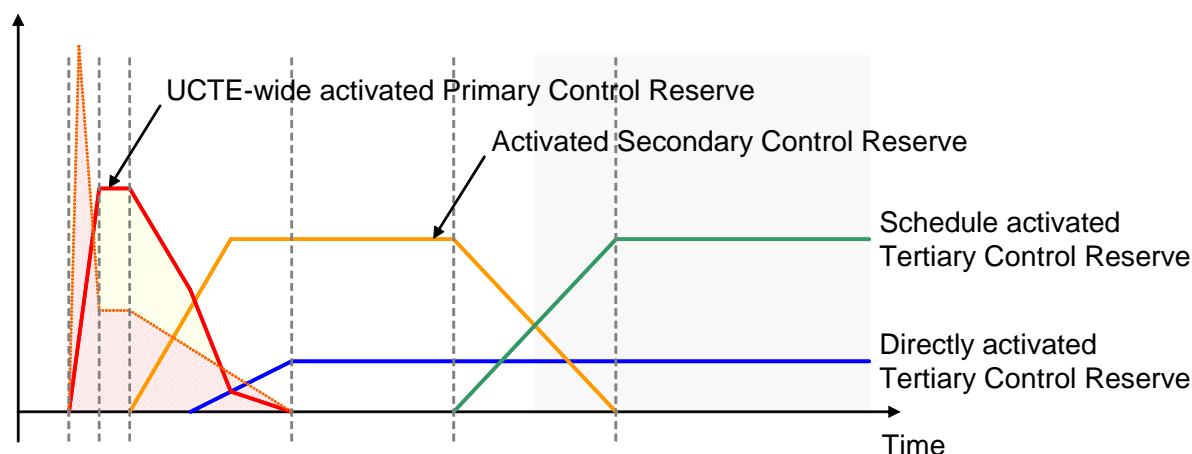

Figure 3: Principle frequency deviation and subsequent activation of reserves

The “TSO-Forum” (organised by the UCTE WG “Operations & Security”) serves as the common body in the UCTE of all TSOs for all operational and organisational items in the framework of Load-Frequency Control and Performance.

Please refer to the glossary of terms of the UCTE Operation Handbook (see ►G) for detailed definitions of terms used within this policy and to Appendix 1 (see ►A1) for basics and principles of load-frequency control and performance.

The updated glossary of terms as well as Appendix 1 of the UCTE “Operation Handbook” are in final revision state / under editorial review and will be available soon. For the time being, please refer to the previous versions of the documents.

V3.0	rev15	01.04.2009	OH-P1-Team	Final version
V3.0	rev14	11.03.2009	OH-P1-Team	Comments from external consultation
V3.0	rev12	15.07.2008	OH-P1-Team	Final draft version
V3.0	rev1	08.05.2007	OH-P1-Team	Revision and update of the structure
v2.2	final	20.07.2004	OH-P1-Team	Final version
v1.0	draft	13.09.2002	WG Op&Sec	draft
v0.0	draft	20.02.2002	WG Op&Sec / AI	Initial internal version

Current status

This version of the document (version 3.0, level C, dated 12.03.2009) has “rev15” status.

This document and other chapters of the UCTE Operation Handbook as well as excerpts from it may not be published, redistributed or modified in any technical means or used for any other purpose outside of UCTE without written permission in advance.

A. Primary Control

[UCTE Operation Handbook Appendix 1 Chapter A: Primary Control, 2004] {update under preparation}

[UCTE Geographical Distribution of Reserves: Document 3, July 2005]

[UCTE Operation Handbook Appendix 1 Chapter E: Operational Data, 2008] {update under preparation}

Introduction

The objective of PRIMARY CONTROL is to maintain a balance between generation and consumption (demand) within the SYNCHRONOUS AREA. By the joint action of all interconnected parties / TSOs, PRIMARY CONTROL aims at the operational reliability of the power system of the SYNCHRONOUS AREA and stabilises the SYSTEM FREQUENCY at a stationary value after a disturbance or incident in the time-frame of seconds, but without restoring the SYSTEM FREQUENCY and the power exchanges to their reference values (see ►►P1-B for SECONDARY CONTROL). Adequate PRIMARY CONTROL depends on generation or load resources made available to the TSOs. Please refer to Appendix 1 (see ►►A1-A) for basics and principles of PRIMARY CONTROL.

Definitions

A-D1. Nominal Frequency. The NOMINAL FREQUENCY value in the SYNCHRONOUS AREA is 50.000 Hz. The set-point frequency (or scheduled frequency) f_0 (see ►►P1-D) defines the target value of the SYSTEM FREQUENCY f for system operation. Outside periods for the correction of SYNCHRONOUS TIME (see ►►P1-D) the scheduled frequency is the NOMINAL FREQUENCY.

A-D2. Frequency Levels and Frequency Deviations. A frequency deviation away from the NOMINAL FREQUENCY results from an imbalance between generation and demand, that occurs continually during normal system operation or after an incident like a loss of generation. A FREQUENCY DEVIATION Δf (the difference “ $f-f_0$ ” of the actual SYSTEM FREQUENCY f from the scheduled frequency f_0) results from an unwanted imbalance between generation and demand. Different criteria are used to distinguish the size of this deviation:

A-D2.1. Activation of PRIMARY CONTROL. PRIMARY CONTROL activation is triggered before the FREQUENCY DEVIATION towards the nominal frequency exceeds ± 20 mHz (the sum of the accuracy of the local frequency measurement and the insensitivity of the controller, see ►►P1-A-S1).

A-D2.2. Maximum Permissible Quasi-Steady-State Frequency Deviation after Reference Incident. A quasi-steady-state FREQUENCY DEVIATION of ± 180 mHz away from the nominal frequency is permitted as a maximum value in the UCTE SYNCHRONOUS AREA after occurrence of a reference

incident after a period of initially undisturbed operation. When assuming that the effect of self-regulation of the load is absent, the maximum permissible quasi-steady-state deviation would be ± 200 mHz. This deviation causes full activation of PRIMARY CONTROL within the UCTE SYNCHRONOUS AREA and (passive) self-regulation of load, see [P1-A-D3.1](#) and [P1-A-D4.1](#).

A-D2.3. Minimum Instantaneous Frequency after Loss of Generation. The minimum instantaneous frequency is defined to be 49.2 Hz (that corresponds to -800 mHz as maximum permissible dynamic FREQUENCY DEVIATION from the nominal frequency [P1-A-D1](#)) in response to a shortfall in generation capacity equal to or less than the REFERENCE INCIDENT according to [P1-A-D3.1](#).

A-D2.4. Maximum Instantaneous Frequency after Loss of Load. The maximum instantaneous frequency is defined to be 50.8 Hz (that corresponds to +800 mHz as maximum permissible dynamic FREQUENCY DEVIATION from the nominal frequency [P1-A-D1](#)) in response to a loss of load or interruption of power exchanges equal to or less than the REFERENCE INCIDENT according to [P1-A-D3.1](#).

A-D2.5. Full Activation of PRIMARY CONTROL RESERVES. In case of a quasi-steady-state deviation of the SYSTEM FREQUENCY of ± 200 mHz from the NOMINAL FREQUENCY, all available primary control reserves are expected to be fully activated.

A-D3. Reference Incident. The maximum instantaneous power deviation between generation and demand in the un-split SYNCHRONOUS AREA (by the sudden loss of generation capacity or load-shedding / loss of load) to be handled by PRIMARY CONTROL starting from undisturbed operation depends on the size of the SYNCHRONOUS AREA and of the largest generation unit or generation capacity connected to a single bus bar.

A-D3.1. Reference Incident for the UCTE SYNCHRONOUS AREA. For the UCTE SYNCHRONOUS AREA the maximum instantaneous power deviation is defined to be 3000 MW, based on operational characteristics concerning system reliability and size of loads and generation units (see also [P1-A-D2.2](#)).

A-D3.2. Observation Incident Size for System Response Analysis. Large incidents, such as the sudden loss of generation or load, that exceed 600 MW (first level) respectively 1000 MW (second level) in the UCTE SYNCHRONOUS AREA, trigger a UCTE system response analysis procedure.

A-D4. PRIMARY CONTROL Characteristics. The following key values of the PRIMARY CONTROL are used (see [A1-E](#) for the complete table of the up-to-date values).

- A-D4.1. SELF-REGULATION of Load.** The self-regulation of the load in the UCTE SYNCHRONOUS AREA is assumed to be 1 %/Hz, that means a load decrease of 1 % occurs in case of a frequency drop of 1 Hz. See ►A1-E for the calculated NETWORK POWER FREQUENCY CHARACTERISTIC of SELF-REGULATION for the UCTE SYNCHRONOUS AREA.
- A-D4.2. Quasi Steady-State Security Margin.** For FREQUENCY CONTROL, the quasi steady-state security margin is defined to be 20 mHz.
- A-D4.3. Minimum NETWORK POWER FREQUENCY CHARACTERISTIC of PRIMARY CONTROL.** The minimum NETWORK POWER FREQUENCY CHARACTERISTIC of PRIMARY CONTROL for the UCTE SYNCHRONOUS AREA is calculated out of ►P1-A-D3.1 and ►P1-A-D2.2 (including the security margin ►P1-A-D4.2) to 15000 MW/Hz.
- A-D4.4. Average NETWORK POWER FREQUENCY CHARACTERISTIC of PRIMARY CONTROL.** On average, the NETWORK POWER FREQUENCY CHARACTERISTIC of PRIMARY CONTROL is experienced to be 30 % higher than the Minimum NETWORK POWER FREQUENCY CHARACTERISTIC of PRIMARY CONTROL, that results on average to 19500 MW/Hz.
- A-D4.5. SURPLUS-CONTROL OF GENERATION.** The SURPLUS-CONTROL OF GENERATION is an experienced linear responses of approximately 50 % of all generation units reacting to FREQUENCY DEVIATIONS. This results in an additional value of self-control of generation, that is calculated based on the mean generation power in the system (see ►A1-E for the calculated values). This SURPLUS-CONTROL OF GENERATION exists in addition to the MINIMUM NETWORK POWER CHARACTERISTIC OF PRIMARY CONTROL.
- A-D4.6. Overall NETWORK POWER FREQUENCY CHARACTERISTIC.** The Overall NETWORK POWER FREQUENCY CHARACTERISTIC for the UCTE SYNCHRONOUS AREA is the sum of contributions from PRIMARY CONTROL of 19500 MW/Hz, the Surplus-Control of Generation and self regulation of load (see ►P1-A-D4.3, A-D4.4, A-D4.5 and A-D4.1). See ►A1-E for the up-to-date value of the Overall NETWORK POWER FREQUENCY CHARACTERISTIC for the UCTE SYNCHRONOUS AREA.
- A-D4.7. Overall PRIMARY CONTROL RESERVE.** With respect to the size of the reference incident of 3000 MW (see ►P1-A-D3.1), the overall PRIMARY CONTROL RESERVE for the UCTE SYNCHRONOUS AREA is agreed to be 3000 MW.

Standards

A-S1. PRIMARY CONTROL Reliability and Target. In case of a first contingency or incident according to ►►P1-A-D3, such as the loss of generation or load or interruption of power exchanges in an undisturbed situation, PRIMARY CONTROL must maintain reliable system operation. Starting from undisturbed operation (see ►►P1-A-D2), a reference incident (see ►►P1-A-D3) must be handled by PRIMARY CONTROL alone, without the need for under-frequency automatic LOAD-SHEDDING or disconnection of generation in response to a FREQUENCY DEVIATION.

A-S1.1. PRIMARY CONTROL Organisation. An organisational procedure to cover requirements and obligations for PRIMARY CONTROL actions and reserves performed by third parties in the CONTROL AREA including a monitoring procedure must be in place (e.g. GridCode, regulation, association agreement or contract).

A-S2. PRIMARY CONTROL Action by Generators or Loads. The action of the generators or loads performing PRIMARY CONTROL must have the following characteristics, to be ensured by all TSOs:

A-S2.1. Accuracy of Frequency Measurements. For PRIMARY CONTROL, the accuracy of local frequency measurements used in the PRIMARY CONTROLLERS must be better than or equal to 10 mHz.

A-S2.2. Adjustment of Power and Insensitivity of Controllers. Power under PRIMARY CONTROL must be proportionally adjusted to follow changes of SYSTEM FREQUENCY. The insensitivity range of PRIMARY CONTROLLERS should not exceed ± 10 mHz. Where dead bands exist in specific controllers, these must be offset within the CONTROL AREA / BLOCK concerned.

A-S2.3. Physical Deployment Times. The time for starting the action of PRIMARY CONTROL is a few seconds after the incident, the deployment time for 50 % or less of the total PRIMARY CONTROL RESERVE is at most 15 seconds and from 50 % to 100 % the maximum deployment time rises linearly to 30 seconds. Each TSO must check the deployment times within his CONTROL AREA / BLOCK on a regular basis. By this, the total PRIMARY CONTROL within the entire SYNCHRONOUS AREA (as well as within each CONTROL AREA / BLOCK) follows the same deployment times.

A-S2.4. Duration of Delivery. PRIMARY CONTROL POWER must be delivered until the power deviation is completely offset by the SECONDARY / TERTIARY CONTROL RESERVE of the CONTROL AREA / BLOCK in which the power deviation has occurred (the minimum duration for the capability of delivery for primary control is 15 minutes, see ►►P1-B).

A-S3. Joint Action for PRIMARY CONTROL. PRIMARY CONTROL is based on the principle of joint action to ensure system reliability and interconnected operation. This includes an overall distribution of reserves and control actions, as determined and decided by the “TSO-Forum” on an annual basis for the next calendar year (see ►P1-A-G2).

A-S3.1. Contribution to PRIMARY CONTROL RESERVE. The total PRIMARY CONTROL RESERVE (in MW) required for operation of the UCTE SYNCHRONOUS AREA is of the same size as the reference incident. Each CONTROL AREA / BLOCK must contribute to the PRIMARY CONTROL RESERVE proportionally, so that the sum of all shares amounts to the total required PRIMARY CONTROL RESERVE. The respective shares (mandatory PRIMARY CONTROL RESERVES) are defined by multiplying the Overall PRIMARY CONTROL RESERVE for the entire SYNCHRONOUS AREA (see ►P1-A-D4.7) and the contribution coefficients c_i of the various CONTROL AREAS / BLOCKS (see ►P1-A-G3). Any CONTROL AREA can increase its PRIMARY CONTROL RESERVE by 30 % by offering to cover (part of) the obligations of other CONTROL AREAS. However, every CONTROL AREA is allowed to increase its PRIMARY CONTROL RESERVE by 90 MW to cover (part of) the obligations of other CONTROL AREAS (which is approx. 3 % of total UCTE PRIMARY CONTROL RESERVE and corresponds to the limitation for loss of PRIMARY CONTROL RESERVE, see ►P1-A-S3.3).

A-S3.2. Contribution to PRIMARY CONTROL Action. Each CONTROL AREA / BLOCK must contribute to the correction of a disturbance in accordance with its respective contribution coefficient c_i for PRIMARY CONTROL (see ►P1-A-G3).

A-S3.3. Limitation for Loss of PRIMARY CONTROL RESERVE. If a generator, on which PRIMARY CONTROL RESERVE is allocated, trips, the immediate loss of PRIMARY CONTROL RESERVE must be limited to 90 MW or 3 % of the reference incident size (by this the decline of the NETWORK POWER FREQUENCY CHARACTERISTIC will be limited).

A-S3.4. Responsibilities in the Process. Each RESERVE CONNECTING TSO is responsible for the PRIMARY CONTROL contribution of the CONTROL AREA, including cross-border PRIMARY CONTROL contributions for other CONTROL AREAS. This includes the contribution, the monitoring, the general procedure and the information exchange for PRIMARY CONTROL RESERVE.

A-S3.5. Information Exchange between TSOs. The RESERVE RECEIVING TSO communicates to the RESERVE CONNECTING TSO by which amount the value of its K-FACTOR must be increased or decreased before the beginning or termination of any exchanging transaction of power for PRIMARY CONTROL. In the case of transactions within a CONTROL BLOCK with pluralistic control mode these K-FACTOR values must be communicated to the CONTROL BLOCK

OPERATOR. The CONTROL BLOCK OPERATOR will then verify whether the total sum of the new K-FACTORS K_{ri} involved in the transaction is equal to the total sum of the original K-FACTOR values.

A-S4. Primary Control Reserve Characteristics. The PRIMARY CONTROL RESERVE needs to have certain characteristics to be usable for PRIMARY CONTROL.

A-S4.1. Availability of Reserves. As a minimum in an undisturbed situation, the mandatory PRIMARY CONTROL RESERVE for each CONTROL AREA (see ►P1-A-S3.1) must be available continuously without interruption, not depending on the unit commitment in detail. PRIMARY and SECONDARY CONTROL RESERVES must be available for activation independently.

A-S4.2. Operational Usability of Reserves. The mandatory PRIMARY CONTROL RESERVE for each CONTROL AREA (see ►P1-A-S3.1) must be fully activated in response to a quasi-steady-state FREQUENCY DEVIATION of ± 200 mHz or more, see ►P1-A-D2.5.

A-S4.3. Border-crossing PRIMARY CONTROL RESERVE. Exchange of reserves for PRIMARY CONTROL crossing the border of the CONTROL AREA can only be allowed if the concerned TSOs have previously confirmed this exchange and if the reserve is exchanged directly between adjacent CONTROL AREAS or remains inside the same CONTROL BLOCK. Additional power flows induced by cross-border PRIMARY CONTROL RESERVE activation have to be considered in the determination of the capacity reliability margin. Each TSO has to consider worst case conditions for the PRIMARY CONTROL POWER flow.

A-S4.4. Contribution of PRIMARY CONTROL RESERVE to one CONTROL AREA. individual generation units or individual loads may only deliver PRIMARY CONTROL RESERVE / POWER to one CONTROL AREA at any time, PRIMARY CONTROL may not be split for different CONTROL AREAS. A generation unit or load can only have obligations to one RESERVE RECEIVING TSO at any time to assure transparent verification of PRIMARY CONTROL contributions from a generation unit or load to the single RESERVE RECEIVING TSO.

A-S4.5. Minimum Amount of PRIMARY CONTROL RESERVES within CONTROL AREAS / BLOCKS. Each TSO must declare to the “TSO-Forum” on annual basis the individual minimum amount of the PRIMARY CONTROL RESERVES that needs to be kept within the CONTROL AREA / BLOCK due to security needs (as a share of the mandatory amount).

A-S4.6. Maximum Amount of PRIMARY CONTROL RESERVES transferred from CONTROL AREAS / BLOCKS. Each TSO must declare to the “TSO-Forum” on annual basis the individual maximum amount of the PRIMARY CONTROL RESERVES that can be transferred safely to other CONTROL AREAS out of the

own CONTROL AREA.

A-S4.7. Monitoring of Redistribution of PRIMARY CONTROL RESERVES. Since the redistribution of PRIMARY CONTROL RESERVE is a global topic that affects all TSOs, any change in the distribution of PRIMARY CONTROL RESERVES outside of the CONTROL AREA and CONTROL BLOCK needs to be declared to the “TSO-Forum”.

A-S5. Monitoring and Observation.

A-S5.1. Observation of Outages. Outages in production or consumption exceeding the size of the observation incident (see ►P1-A-D3.2) are recorded for analysis by the TSO. The required information about location, time, size and type of the disturbance / incident is recorded and made available to the members of the association via the “TSO-Forum”. For second level incidents all TSOs are obliged to submit information on their primary contribution to the “TSO Forum”.

A-S5.2. Cross-border Reserves. Monitoring must be executed by the RESERVE CONNECTING TSO. Monitoring is based on the frequency measurement and the generation unit or load active power measurements, located at the network injection point in the network of the RESERVE CONNECTING TSO.

A-S5.3. Measurement Cycle for Frequency Observation. The cycle for measurements of the SYSTEM FREQUENCY for CONTROL AREA observation must be in the range of 1 second (strongly recommended) to at most 10 seconds.

Guidelines

A-G1. Incident Size Determination. The values of the incident sizes (see P1-A-D3.2) are determined and proposed by the “TSO-Forum” and need approval by all UCTE members.

A-G2. Determination of overall NETWORK POWER FREQUENCY CHARACTERISTIC. The final value of the overall NETWORK POWER FREQUENCY CHARACTERISTIC is determined by the “TSO-Forum” on a regular basis, see ►A1-E.

A-G3. Contribution Coefficients Determination. The contribution coefficients are determined and published annually for each CONTROL AREA / BLOCK. The contribution coefficients are binding for the corresponding interconnection partner / TSO for one calendar year. They are based on the share of the energy generated within one year in proportion to the entire SYNCHRONOUS AREA. The sum of all contributions coefficients must amount to 1. The “TSO-Forum” determines and decides about the contribution coefficients of each CONTROL AREA / BLOCK for the UCTE SYNCHRONOUS

AREA on an annual basis (published before the 1st of December) and sets these values into operation on the 1st of January of the next year.

A-G4. Constant NETWORK POWER FREQUENCY CHARACTERISTIC. In order to ensure that the principle of joint action is observed, the NETWORK POWER FREQUENCY CHARACTERISTICS of the various CONTROL AREAS is taken to remain as constant as possible. This applies particularly to small FREQUENCY DEVIATIONS, where the "dead bands" of generators may have an unacceptable influence upon the supply of PRIMARY CONTROL energy in the CONTROL AREAS concerned.

A-G5. Contracting PRIMARY RESERVE in a neighbouring CONTROL AREA or inside a CONTROL BLOCK: A TSO may contract PRIMARY RESERVE in a neighbouring CONTROL AREA or inside a CONTROL BLOCK. Contracts for providing this service may be signed as TSO-TSO or as TSO-GenCo. This implies that an agreement between the concerned TSOs has been signed, e.g. concerning the setting of the K-factors on the SECONDARY CONTROLLER (see ►P1-B). The "TSO-Forum" will perform simulations to check the consequences for the overall system security on an annual basis. As a result, ultimate limits can be given to individual TSOs.

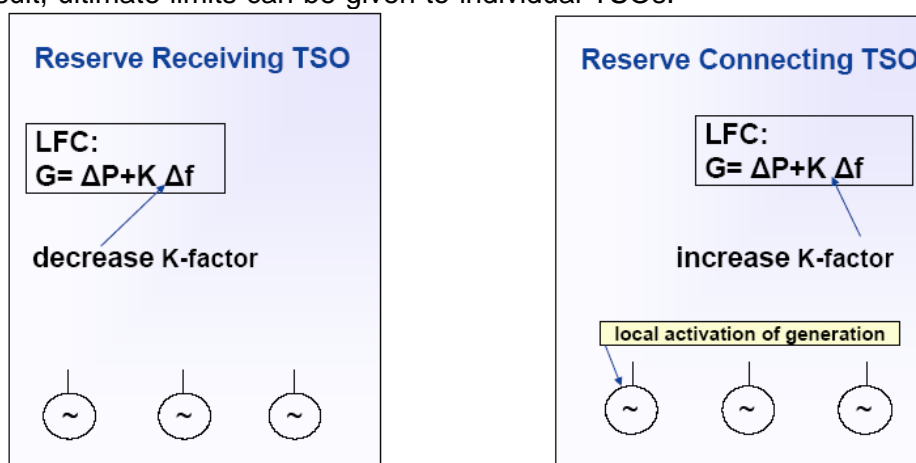

Figure 4: Contracting PRIMARY RESERVE in a neighbouring CONTROL AREA / BLOCK

A-G6. Control Performance Measurement. The NETWORK POWER FREQUENCY CHARACTERISTIC is calculated in response to a disturbance (such as an observation incident), based on measurements of the SYSTEM FREQUENCY and other key values and on a statistical analysis.

A-G6.1. Control Performance Report. UCTE publishes results of the control performance analysis on a regular basis in the "Regular Report of the Performance of the Primary and Secondary Load-Frequency Control", prepared by the "TSO-Forum".

B. Secondary Control

[UCTE Operation Handbook Appendix 1 Chapter B: Secondary Control, 2004] {update under preparation}

[UCTE Geographical Distribution of Reserves: Document 4, July 2005]

[UCTE Geographical Distribution of Reserves: Document 5, July 2005]

[UCTE Operation Handbook Appendix 1 Chapter E: Operational Data, 2008] {update under preparation}

Introduction

SECONDARY CONTROL maintains a balance between GENERATION and consumption (DEMAND) within each CONTROL AREA / BLOCK as well as the SYSTEM FREQUENCY within the SYNCHRONOUS AREA, taking into account the CONTROL PROGRAM, without impairing the PRIMARY CONTROL that is operated in the SYNCHRONOUS AREA in parallel (see ►P1-A).

SECONDARY CONTROL makes use of a centralised and continuous AUTOMATIC GENERATION CONTROL, modifying the active power set points / adjustments of GENERATION SETS / controllable load in the time-frame of seconds up to typically 15 minutes after an incident. SECONDARY CONTROL is based on SECONDARY CONTROL RESERVES that are under automatic control. Adequate SECONDARY CONTROL depends on generation resources made available by generation companies to the TSOs, independently from PRIMARY CONTROL RESERVES. Please refer to Appendix 1 (see ►A1-B) for basics and principles of SECONDARY CONTROL.

Definitions

B-D1. K-Factor. The K-factor is part of SECONDARY CONTROL to link frequency and power deviations in the SECONDARY CONTROLLER.

B-D1.1. Definition of K-factor. A value given in megawatts per Hertz (MW/Hz) for a CONTROL AREA / BLOCK that defines the FREQUENCY BIAS of that CONTROL AREA for SECONDARY CONTROL (dependency between SYSTEM FREQUENCY and deviation from power exchanges due to expected PRIMARY CONTROL Activation in this CONTROL AREA / BLOCK).

B-D1.2. K-Factor Calculation. The K-FACTOR K_{ri} of a CONTROL AREA / BLOCK for SECONDARY CONTROL is calculated by the product of the contribution coefficient c_i of that area (see ►P1-A-S3.1) and the OVERALL NETWORK POWER FREQUENCY CHARACTERISTIC (see ►P1-A-D4.6 and ►A1-E).

B-D2. AREA CONTROL ERROR. A disturbance or an incident results in an AREA CONTROL ERROR (in short ACE, deviation for SECONDARY CONTROL). The ACE for a CONTROL AREA / BLOCK is calculated as the sum of the POWER CONTROL ERROR and the frequency control error (" $\Delta P + K^* \Delta f$ ").

B-D2.1. POWER CONTROL ERROR. The POWER CONTROL ERROR ΔP of a CONTROL AREA / BLOCK is the total POWER DEVIATION of that area in interconnected

operation, calculated as the difference between the total TIE-LINE active power flow P (sum of all related measurements including VIRTUAL TIE-LINES) and the CONTROL PROGRAM P_0 (sum of all related exchange schedules and the compensation programs) according to “ $P-P_0$ ”.

B-D2.2. FREQUENCY CONTROL ERROR. The frequency control error “ $K^* \Delta f$ ” of a CONTROL AREA / BLOCK is the product of the FREQUENCY DEVIATION Δf (see also ►P1-A-D2) and the K-FACTOR of the CONTROL AREA / BLOCK K_{ri} (see ►P1-B-D1.2).

B-D3. Special Operation Modes and States for SECONDARY CONTROL. Under certain rare conditions, SECONDARY CONTROLLERS may need to be operated in different predefined operation modes other than the normal operation mode, always impairing the FREQUENCY POWER NETWORK CHARACTERISTIC METHOD. In operational practice (e.g. after a split in the transmission network), the operation modes may also be slightly different, based on the decisions of the operator.

B-D3.1. Frequency Control Mode. Under rare operational conditions, frequency control mode operation of secondary control can be activated by the operator. In this operation mode, the POWER CONTROL ERROR (►P1-B-D2.1) is not included in the AREA CONTROL ERROR calculation. Also in case of island operation, where all interconnections / TIE-LINES of a CONTROL AREA / BLOCK are disconnected (e.g. after a disturbance the CONTROL AREA is not connected to the rest of the SYNCHRONOUS AREA any more) and thus no exchange programs can be realized, the operator switches to frequency control mode. In this operation mode, the AREA CONTROL ERROR is defined by the FREQUENCY CONTROL ERROR (►P1-B-D2.2) only.

B-D3.2. Tie-Line Control Mode. In case of an invalid frequency measurement TIE-LINE control mode operation of SECONDARY CONTROL has to be activated automatically or manually by the operator. In this operation mode, the FREQUENCY CONTROL ERROR (►P1-B-D2.2) is not included in the AREA CONTROL ERROR calculation. In this operation mode, the AREA CONTROL ERROR is defined by the POWER CONTROL ERROR (►P1-B-D2.1) only.

B-D3.3. Frozen Control State. Under uncertain operational conditions, control should be frozen by the operator to evaluate the situation. In this state, no changes of the set-points for SECONDARY CONTROL are made by the controller. Until released again, the SECONDARY CONTROLLER remains passive, the set-points are frozen and no AREA CONTROL ERROR is controlled.

B-D3.4. Stopped Control State. Under unreasonable conditions for SECONDARY CONTROL (like after a split of the network within the CONTROL AREA / BLOCK with different frequencies), the SECONDARY CONTROLLER should be stopped

(until started again with initialised set-point values and controller states).

B-D4. Organisation of SECONDARY CONTROL. There are three different schemes defined for the organisation of SECONDARY CONTROL in a CONTROL BLOCK.

B-D4.1. Centralised: SECONDARY CONTROL for the CONTROL BLOCK is performed centrally by a single controller (only one CONTROL AREA located inside of the CONTROL BLOCK); the operator of the CONTROL BLOCK has the same responsibilities as the operator of a CONTROL AREA.

B-D4.2. Pluralistic: SECONDARY CONTROL is performed in a decentralised way with more than one CONTROL AREA; a single TSO (the BLOCK CO-ORDINATOR) regulates the whole block towards its neighbouring CONTROL BLOCKS with its own SECONDARY CONTROLLER and regulating capacity, while all the other TSOs of the CONTROL BLOCK regulate their own CONTROL AREAS in a decentralised way on their own.

B-D4.3. Hierarchical: SECONDARY CONTROL is performed in a decentralised way with more than one CONTROL AREA; a single TSO (the BLOCK CO-ORDINATOR), operates the superposed block controller which directly influences the subordinate SECONDARY CONTROLLERS of all CONTROL AREAS of the CONTROL BLOCK; the BLOCK CO-ORDINATOR may or may not have regulating capacity on its own.

B-D5. Methodologies for Sizing of Control Reserves (Secondary and Tertiary).

Different methodologies for sizing the control reserves reflect and define in general the different operational needs in CONTROL AREAS of UCTE, due to different characteristics and patterns of generation (including hydraulic, thermal and HVDC-link) and demand (including balance responsible parties and forecast qualities). The sizing of the SECONDARY and TERTIARY CONTROL RESERVE is done by reference to deterministic and / or probabilistic approaches.

B-D5.1. Empiric Noise Management Sizing Approach (“Control Capability for Variations”) for SECONDARY CONTROL RESERVE. The following square-root formula is used as an empiric sizing approach for the recommended minimal amount of SECONDARY CONTROL RESERVE R of a CONTROL AREA in order to control the load and generation variations (noise signal):

$$R = \sqrt{a \cdot L_{\max} + b^2} - b$$

with L_{\max} being the maximum anticipated consumer load for the CONTROL AREA over the period considered and the parameters a and b being established empirically with the following values: $a=10$ MW and $b=150$ MW.

B-D5.2. Probabilistic Risk Management Sizing Approach (“Probability for Reserve Deficits”). A probabilistic sizing approach for the total required

reserve (secondary and tertiary) is based on a requirement to enable the control of the AREA CONTROL ERROR to zero in for example 99,9 % of all hours during the year (that in this case corresponds to up to 9 hours of deficits in the reserve expected for a full year). The calculation of the size of the reserve is based on the individual distribution curve of the power imbalance (local recovery of imbalances by GenCo, BRP and others, depending on the market system) of the CONTROL AREA (statistical data).

B-D5.3. Largest Generation Unit or Power Infeed (“Control largest Incident”).

The sizing of the required reserve is done based on the assumption and expectation of the largest possible generation incident (e.g. generation units or sets, HVDC-links, power infeed on single bus-bars) that is considered to happen for the CONTROL AREA). The size of the total reserve must match the size of the incident.

B-D5.4. Extra-ordinary Sizing of Reserves. Other criteria might influence the size of the reserve e.g. capability to control large changes in total exchange programs, topology of the CONTROL AREA / BLOCK, expected load variations and behaviour or other special situations like events of public interest, adverse climatic conditions, strikes etc.

B-D6. Tie-Lines. The area demarcation of a CONTROL AREA / BLOCK towards the rest of the UCTE SYNCHRONOUS AREA is based on TIE-LINES. Different types of TIE-LINES can be distinguished.

B-D6.1. Physical Tie-Lines. PHYSICAL TIE-LINES are those transmission lines and transformers on all voltage levels that connect two different CONTROL AREAS / BLOCKS. The active power flow on each PHYSICAL TIE-LINE is measured.

B-D6.2. Virtual Tie-Lines. VIRTUAL TIE-LINES connect generation units in the CONTROL AREA of the CONNECTING TSO to the CONTROL AREA of the RECEIVING TSO. The active power flow on each VIRTUAL TIE-LINE is either measured (in case of the direct transmission of the absolute generation) or calculated out of measurements with an agreed fixed formula (in case of the transmission of a defined generation share or of generation relative to a schedule only). The delivery of border-crossing SECONDARY CONTROL RESERVE and DIRECTLY ACTIVATED TERTIARY CONTROL RESERVE (see ►P1-C-D1.1) is done by use of VIRTUAL TIE-LINES.

B-D7. Adaptation of SECONDARY CONTROLLER for border-crossing SECONDARY CONTROL. Two different scenarios for technical realization of border crossing SECONDARY CONTROL are defined. In any scenario it must be ensured, that by these means only SECONDARY CONTROL is transported border-crossing and e.g. PRIMARY CONTROL generated by the same units does not cross the border unintentionally.

B-D7.1. Control of Generation Unit by Reserve Receiving TSO and delivery of the activated Reserve by Measurement Value from Generation Unit. In the case of direct control of the generation unit the LOAD FREQUENCY CONTROL of the RESERVE RECEIVING TSO sends its request for power directly to the generation unit (either an absolute value including underlying schedule or a relative value only for SECONDARY CONTROL only). The measurement value (either an absolute or a relative value corresponding to the request) is used for adaptation of the SECONDARY CONTROLLERS of both the RESERVE CONNECTING and the RESERVE RECEIVING TSO. This introduces the concept of VIRTUAL TIE-LINE which connects the generation unit in the CONTROL AREA of the RESERVE CONNECTING TSO directly to the CONTROL AREA of the RESERVE RECEIVING TSO.

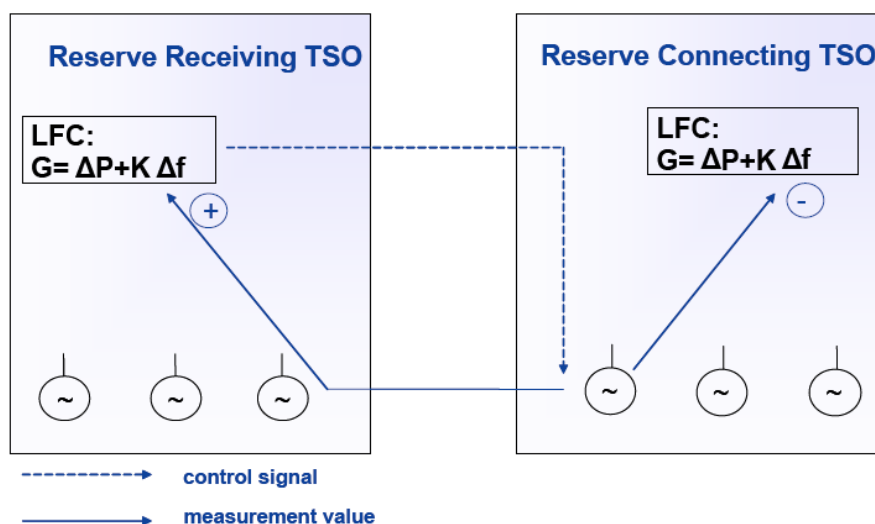

Figure 5: Control of Generation Unit by Reserve Receiving TSO and delivery of the activated Reserve by Measurement Value from Generation Unit

B-D7.2. Control by Reserve Receiving TSO through the Reserve Connecting TSO. The RESERVE RECEIVING TSO sends its request for power directly to the RESERVE CONNECTING TSO. The RESERVE CONNECTING TSO adjusts either the power of the plants which the RESERVE RECEIVING TSO has contracted with or the power plants the RESERVE CONNECTING TSO has contracted with itself.

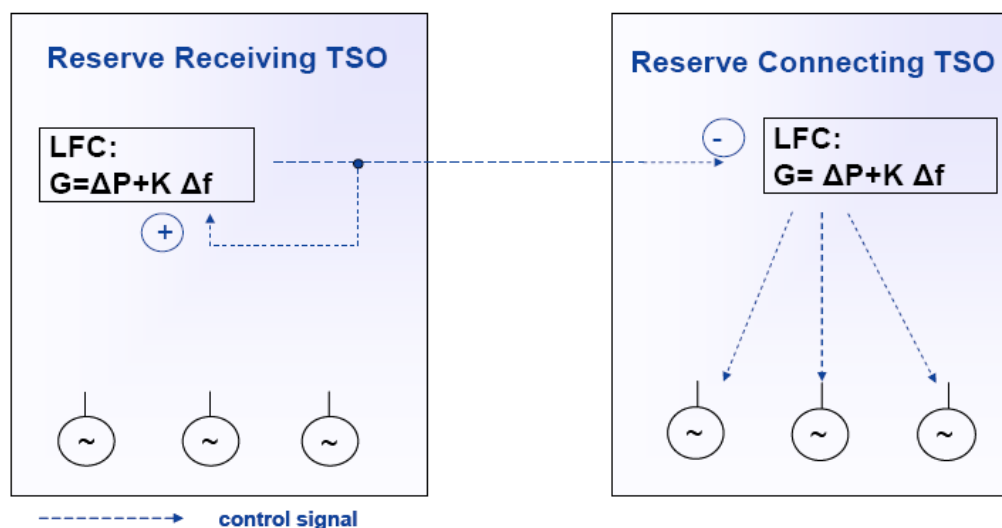

Figure 6: Control by Reserve Receiving TSO through the Reserve Connecting TSO

Standards

B-S1. Organisation of SECONDARY CONTROL.

B-S1.1. Operator. Each CONTROL AREA / BLOCK must be operated by an individual TSO that has the responsibility for the transmission system operation of this area (usually coincident with the territory of a company or a country), including the responsibility for availability, operation and provision of PRIMARY CONTROL, SECONDARY CONTROL and TERTIARY CONTROL within the CONTROL AREA / BLOCK to maintain the POWER INTERCHANGE of its CONTROL AREA / BLOCK at the scheduled value and, consequently, to support the restoration of FREQUENCY DEVIATIONS in the interconnected network.

B-S1.2. Control Hierarchy and Organisation. The type of control hierarchy and organisation must not influence the behaviour or quality of SECONDARY CONTROL in a negative way or introduce control instability (e.g. cascaded controllers with integral parts can result to impaired or unstable SECONDARY CONTROL). Each CONTROL BLOCK may divide up into sub-control areas that operate their own underlying generation control. A CONTROL BLOCK organises the internal SECONDARY CONTROL according to one of the schemes centralised, pluralistic or hierarchical (see ►B-D5). All CONTROL BLOCK operators must declare the control hierarchy and organisation to the “TSO-Forum” in case of change.

B-S2. Operation of SECONDARY CONTROL: Each TSO operates sufficient control reserves under automatic control by the SECONDARY CONTROLLER to meet its obligation to continuously balance its generation and interchange schedules to its load for the CONTROL AREA / BLOCK.

B-S2.1. Control Target for SECONDARY CONTROL. In general, the target is to control random deviations of the SYSTEM FREQUENCY and the POWER EXCHANGES during normal operation with normal noise and after a large incident. The AREA CONTROL ERROR (ACE) as a linear combination of FREQUENCY DEVIATION and POWER DEVIATION must be controlled to return the SYSTEM FREQUENCY and the POWER EXCHANGES to their set point values after any deviation and at any time. After 30 seconds at the latest, the SECONDARY CONTROLLER must start the control action by change in the set-point values for SECONDARY CONTROL to initiate corrective control actions. As a result of SECONDARY CONTROL, the return of the ACE must continue with a steady process of correction of the initial ACE as quickly as possible, without overshoot, being completed within 15 minutes at the latest.

B-S2.2. Usage of SECONDARY CONTROL. SECONDARY CONTROL must only be used in order to correct an AREA CONTROL ERROR. SECONDARY CONTROL must not be used for other purposes, e.g. to minimise unintentional energy deviations or to correct other imbalances. SECONDARY CONTROL shall not counteract PRIMARY CONTROL or the co-ordination of SECONDARY CONTROL in the UCTE SYNCHRONOUS AREA by the NETWORK POWER FREQUENCY CHARACTERISTIC METHOD. The use of special operation modes for SECONDARY CONTROL must be done in a co-ordinated way.

B-S2.3. Capability to control to the Control program. Each operator of a CONTROL AREA / BLOCK has to be capable to follow the control program towards all other CONTROL AREAS / BLOCKS of the SYNCHRONOUS AREA at the committed scheduled value at any time, taking into consideration the expected capabilities of the total generation and load in the CONTROL AREA / BLOCK or generation reserves contracted cross-border to follow changes in the exchange programs.

B-S2.4. Compliance with large Program Changes. In order to prevent systematic unintentional FREQUENCY DEVIATIONS and major control deviations under normal operating conditions, system operators are required to maintain careful compliance with program changes.

B-S2.5. Responsibility of TSOs in case of Border-Crossing Reserves. Any border-crossing SECONDARY CONTROL RESERVE has to be approved by all involved TSOs. The three groups of TSOs involved (RESERVE CONNECTING TSO, RESERVE TRANSITING TSO and RESERVE RECEIVING TSO) endorse their responsibilities including warrant of energy transports, reservation of transmission capacities, monitoring and warning of generation units, activation of reserves, information exchange and general procedure as soon as they accept to take part in the process of border-crossing SECONDARY

CONTROL RESERVES. Specific rules for fault scenarios have to be agreed between the concerned TSOs.

B-S3. SECONDARY CONTROLLER System and Function. In order to control the AREA CONTROL ERROR (see ►P1-B-D2) to zero, SECONDARY CONTROL must be performed in the corresponding control centre by a single automatic SECONDARY CONTROLLER that needs to be operated in an on-line and closed-loop manner.

B-S3.1. Controller Type and Characteristic. In order to have no residual error, the SECONDARY CONTROLLER must be of PI (proportional-integral) type. The integral term must be limited in order to have a non-windup control action, able to react immediately in case of large changes or a change of the sign of the ACE. Measurement cycle times, integration times and controller cycle time must be co-ordinated within the control loop.

B-S3.2. Controller Cycle Time. The cycle time for the automatic SECONDARY CONTROLLER has to be between 1 second and 5 seconds, to minimise the total time delay between occurrence, reaction and response in the scope of the overall control performance of the CONTROL AREA.

B-S3.3. Programmed Values. Programmed values for SECONDARY CONTROL (e.g. for power exchanges and frequency set-points) must be entered into the controller as time-dependant set-point values based on schedules, see ►P2 for details on scheduling.

B-S3.4. Frequency Gain Setting. The setting shall reflect the best approximation of the real NETWORK POWER FREQUENCY CHARACTERISTIC of the CONTROL AREA / BLOCK. The K-Factor (based on the share of the agreed overall network power frequency value) shall serve as the default value for the setting of the frequency gain in the SECONDARY CONTROLLER. The default setting needs to be adapted in case of trade of **primary reserves** across the borders of the CONTROL AREA / BLOCK. Every CONTROL AREA / BLOCK operator must declare the setting of the frequency gain that is applied during normal operation to the “TSO-Forum”.

B-S3.5. Power Exchange Set-Point. The algebraic sum of the programmed power exchanges of the CONTROL AREA / BLOCK (including compensation program) constitutes the input for the POWER EXCHANGE set point of the SECONDARY CONTROLLER. When changes of CONTROL PROGRAMS occur, it is necessary that each change is converted to a ramp with a ramp period of 10 minutes, starting 5 minutes before the agreed time of change (the change of the hour or of the quarter, see ►P2 for definition of exchange schedules) and ending 5 minutes after. The power exchange set-point value may only be composed of values from the schedules including ramp changes.

- B-S3.6. Controller System Clock Setting.** To avoid possible errors due to asynchronous operation of different secondary controllers, the time setting of each SECONDARY CONTROLLER needs to be synchronized to a reference time.
- B-S3.7. Manual Control Capability.** In case of deficiency of the automatic SECONDARY CONTROL capability, manual control of reserves must be possible.
- B-S3.8. Accuracy of Frequency Measurement.** For SECONDARY CONTROL, the accuracy of frequency measurement must be between 1.0 mHz and 1.5 mHz.
- B-S3.9. Frequency Set-Point.** The actual frequency set-point value for TIME CONTROL (see ►P1-D-S7) must be used within the SECONDARY CONTROLLER for calculation of the FREQUENCY DEVIATION, to be able to limit the deviation between SYNCHRONOUS TIME and UTC.
- B-S4. SECONDARY CONTROL RESERVE.** An adequate SECONDARY CONTROL RESERVE must be available to cover expected DEMAND and generation fluctuations. If the loss of the largest generating unit of the CONTROL AREA is not already covered by the requisite SECONDARY CONTROL RESERVE, additional TERTIARY CONTROL RESERVE (see ►P1-C) has to be activated to offset the shortfall within the required time (see P1-B-S2.1).
- B-S4.1. Sufficient Controllable Power and Minimum Size of Reserve.** For each CONTROL AREA / BLOCK sufficient controllable generation or load control must be available in order to have the capability to control the AREA CONTROL ERROR to zero, based on the used probabilistic and deterministic criterions for sizing of the reserves. For FREQUENCY DEVIATIONS smaller than 200 mHz (see ►P1-A-D2.5), SECONDARY and PRIMARY CONTROL RESERVES must be available for activation independently.
- B-S4.2. Supplement by TERTIARY CONTROL RESERVE.** In case of insufficient SECONDARY CONTROL RESERVE (after a sudden large unbalance or during a sustained DEMAND variation), TERTIARY CONTROL RESERVE shall be used in addition to SECONDARY CONTROL RESERVE (see ►P1-C).
- B-S4.3. Declaration of Size of largest Incident to be covered by the Reserves.** Each TSO must declare to the “TSO-Forum” the individual expected maximum size for instantaneous loss of generation or power infeed that is used for sizing of SECONDARY CONTROL RESERVE including directly activated TERTIARY RESERVE.
- B-S4.4. Contribution of Reserve to one CONTROL AREA.** At any point in time, the full SECONDARY CONTROL RESERVE of a single generation unit must not be divided into independent shares and can only contribute to one CONTROL

AREA at the same time. A single generation unit cannot contract SECONDARY CONTROL RESERVE with more than one RESERVE RECEIVING TSO at one time (at any time each generation unit can be involved in only one SECONDARY CONTROL).

B-S4.5. Border-crossing SECONDARY CONTROL RESERVE. SECONDARY CONTROL RESERVE can be exchanged border-crossing if the concerned TSOs have confirmed this exchange and provided that 66 % of the SECONDARY CONTROL RESERVE needed are kept geographically within the CONTROL AREA. In addition a fixed share of 50 % of the total needed SECONDARY CONTROL RESERVE plus TERTIARY CONTROL RESERVE must also be kept inside the CONTROL AREA. Sufficient transmission capacity must be allocated between the RESERVE RECEIVING TSO, the RESERVE TRANSITING TSO and the RESERVE CONNECTING TSO. In case one or more RESERVE TRANSITING TSOs are involved, transmission capacities across the subsequent borders must be available.

B-S4.6. Declaration of SECONDARY CONTROL RESERVE. Each TSO shall declare on a regular basis the sizing of the SECONDARY CONTROL RESERVE to the “TSO-Forum”.

B-S4.7. Declaration of border-crossing SECONDARY CONTROL RESERVE. The amount and times of border-crossing SECONDARY CONTROL RESERVE must be declared by each RESERVE-RECEIVING TSO to all RESERVE TRANSITING TSOs in advance.

B-S5. Area Demarcation at TIE-LINES. Each CONTROL AREA has to be physically demarcated by the position of the points for measurement of the interchanged power to the adjacent interconnected network. The CONTROL AREA demarcation must consider all TIE-LINES that are operated together with neighbouring CONTROL AREAS.

B-S5.1. List of Tie-Lines. The list of TIE-LINES of the CONTROL AREA in operation (including transmission lines and transformers of the different voltage levels and VIRTUAL TIE-LINES e.g. for cross-border exchanges of SECONDARY CONTROL) is maintained and updated on a regular basis and declared to the “TSO-Forum”.

B-S5.2. Radial / Border-Crossing Operation of Generating Units / Demand. In case of the radial operation of generating units or demand these must be considered as internal generating units or demands within exactly one CONTROL AREA / BLOCK, in special cases even not being directly connected (e.g. border-crossing SECONDARY CONTROL RESERVE using VIRTUAL TIE-LINES). Generation units or loads within the UCTE SYNCHRONOUS AREA may not be declared outside of a CONTROL AREA without being assigned to

another CONTROL AREA via a VIRTUAL TIE-LINE.

B-S5.3. Jointly Owned Generating Units. Jointly owned generation units with GENERATION shares assigned to different CONTROL AREAS have to be equipped with metering and measurement equipment providing function of VIRTUAL TIE-LINE between two or more CONTROL AREAS, unless the share of the production is delivered via EXCHANGE SCHEDULE.

B-S5.4. Metering and Measurement. All physical TIE-LINES from a CONTROL AREA to adjacent CONTROL AREAS across the border must have measurements and meters in operation to record the actual active power flow in MW in real-time and the energy in MWh in the time-frame for power exchanges that is used (one hour at the maximum, see ►P2).

B-S5.5. Accuracy of Measurements. The accuracy of the active power measurements on each TIE-LINE must be better than 1.5 % of its highest rated value (the complete measurement range, including discretisation). The local measurement renewal / refresh rate should not exceed 5 seconds and the time stamps of the measurement values at the SECONDARY CONTROLLER should not differ more than 5 seconds to ensure consistent calculations of AREA CONTROL ERROR.

B-S5.6. Total Active Power Flow Measurement. The total active power flow of a CONTROL AREA / BLOCK towards the remaining UCTE SYNCHRONOUS AREA must be calculated by the sum of all power flow measurements of all TIE-LINES of this area (PHYSICAL TIE-LINES and VIRTUAL TIE-LINES). The total active power flow may be composed of measurements only.

B-S6. Control Function Reliability and Monitoring.

B-S6.1. Availability and Reliability of the Control Function. The automatic SECONDARY CONTROLLER is operated on-line and closed-loop and must have a very high availability and reliability. A backup system must be available to overtake the control function in case of an outage or fault of the system for SECONDARY CONTROL. Functions and reserves from all providers used for control must be monitored.

B-S6.2. Transmission of Measurements. Measurements must be transmitted in a reliable manner (e.g. parallel data links) to the SECONDARY CONTROLLER.

B-S6.3. Metering and Measurement Transmission to opposite side. Usage and provision of alternative measurement from neighbouring CONTROL AREAS for comparison or eventual backup are required. Substitute measurements and reserve equipment should be available in parallel to the primary measurement. Substitute measurements are obligatory for all TIE-LINES with

significant impact to SECONDARY CONTROL. Accuracy and cycle times for the substitute TIE-LINE measurements must fulfil the same characteristics (see ►P1-B-S5).

B-S6.4. Data Recordings. Each TSO must perform continuous recordings of all values needed for monitoring of the input and response of SECONDARY CONTROLLERS and for analysis of normal operation and incidents in the INTERCONNECTED SYSTEM. These values include the frequency measurement, the total active power flow measurement and the power exchange set-point value.

Guidelines

B-G1. SECONDARY CONTROLLER. The following recommendations and guidelines are given for the setup of the SECONDARY CONTROLLER (see ►P1-B-S3 for the complementary requirements on the SECONDARY CONTROLLER):

B-G1.1. Controller Type and Characteristic. In case of a very large control deviation, the control parameters β_i and T_n of the SECONDARY CONTROLLER (for proportional and integral part) may be adjusted automatically for a given period of time. The control parameters β_i and T_n are closely linked. At present, typical values ranging from 0 % to 50 % are set for the proportional term β_i of the controller. The time constant represents the "tracking" speed of the SECONDARY CONTROLLER with which the controller activates the control power of participating generators. Typical values ranging from 50 seconds to 200 seconds are set for the time constant T_n .

B-G1.2. Tie-Lines, Transmission of Measurements. Two ways are recommended, with an alarm in case of deficiency of a data transmission. The largest transmission delay should not exceed 5 seconds; it should be as small as possible and below the controller cycle time.

B-G2. "TSO-Forum" Preparatory Work. The TSO-Forum collects and merges the contribution of TSOs to one common overview for the following subjects on a regular basis: control hierarchy overview (see. ►P1-B-S1.2), the Frequency Gain Setting (see ►P1-B-S3.4) and SECONDARY CONTROL RESERVES (see ►P1-B-S4).

B-G3. Monitoring and Observation

B-G3.1. Trumpet Curve Method. The trumpet curve method for NETWORK POWER FREQUENCY CHARACTERISTIC analysis should be used after incidents, see description in detail in Appendix 1 (see ►A1-B).

B-G3.2. SECONDARY CONTROL Performance. CONTROL BLOCK performance analysis is based on predefined "balance quality indicators". The results are

presented in the quarterly report and evaluated by the “TSO-Forum”.

B-G3.3. Sample Interval. The values used for monitoring and observation are based on a sample interval of 10 seconds.

B-G4. Recommended Minimum amount of SECONDARY CONTROL RESERVE. The minimum amount of SECONDARY CONTROL RESERVE (under automatic control) according to the empiric sizing approach formula (see ►P1-B-D5.1) should be guaranteed.

C. Tertiary Control

[UCTE Operation Handbook Appendix 1 Chapter C: Tertiary Control, 2004] {update under preparation}

[UCTE Geographical Distribution of Reserves: Document 6, July 2005]

Introduction

TERTIARY CONTROL uses TERTIARY RESERVE that is usually activated manually by the TSOs in case of observed or expected sustained activation of SECONDARY CONTROL. It is primarily used to free up the SECONDARY RESERVES in a balanced system situation, but it is also activated as a supplement to SECONDARY RESERVE after larger incidents to restore the system frequency and consequently free the system wide activated PRIMARY RESERVE. TERTIARY CONTROL is typically operated in the responsibility of the TSO. Please refer to Appendix 1 (see ►A1-C) for further basics and principles of TERTIARY CONTROL.

Definitions

C-D1. Types of TERTIARY CONTROL RESERVE. TERTIARY CONTROL RESERVE implies changes in generation or load on a contractual, market or regulatory basis. These reserves are activated for a period of time.

C-D1.1. Directly Activated TERTIARY CONTROL RESERVE. Directly activated TERTIARY CONTROL RESERVE can be activated by manual action at any time, independent from a time-frame of exchange schedules. In case of border-crossing activation of reserves, the activation procedure results in a dynamically changing exchange pattern.

C-D1.2. Schedule Activated TERTIARY CONTROL RESERVE. Schedule activated TERTIARY CONTROL RESERVE is activated with relation to the predefined time-frame of exchange schedules, e.g. 15 minutes. A special exchange scheduling procedure is used. It may include exchange rescheduling between TSOs, a special kind of exchange schedule is used.

C-D2. Adaptation of SECONDARY CONTROL for border-crossing TERTIARY CONTROL RESERVE. Two different recommended scenarios for technical realization of border crossing TERTIARY CONTROL RESERVE are considered:

C-D2.1. Direct Activation of the Generation Unit by the Reserve Receiving TSO and Delivery of the activated Reserve by Measurement Value. The activation signal is sent by the RESERVE RECEIVING TSO directly to the generation unit or load with which TERTIARY CONTROL RESERVE was contracted. The on-line measurement value of active power is sent from the generation unit or load back to the SECONDARY CONTROL of both the RESERVE RECEIVING TSO and the RESERVE CONNECTING TSO. If the

generation unit or load produces according to an underlying schedule additional to TERTIARY CONTROL RESERVE the schedule has to be subtracted from the measurement value accordingly.

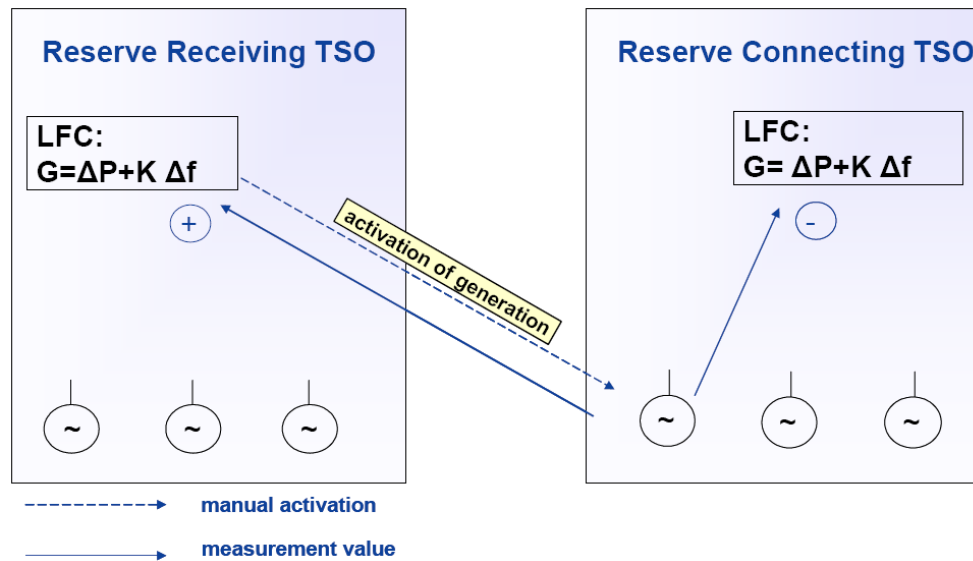

Figure 7: Direct Activation of the Generation Unit by the Reserve Receiving TSO and Delivery of the activated Reserve by Measurement Value (similar for loads)

C-D2.2. Direct Activation of the Generation Unit by the Reserve Receiving TSO and Delivery by Exchange Schedule. The activation signal is sent by the RESERVE RECEIVING TSO directly to the generation unit. The exchange schedule regarding cross-border TERTIARY CONTROL RESERVES, agreed between the RESERVE RECEIVING TSO, the RESERVE CONNECTING TSO and the generation unit, is used to adapt the SECONDARY CONTROL of both RESERVE RECEIVING TSO and RESERVE CONNECTING TSO.

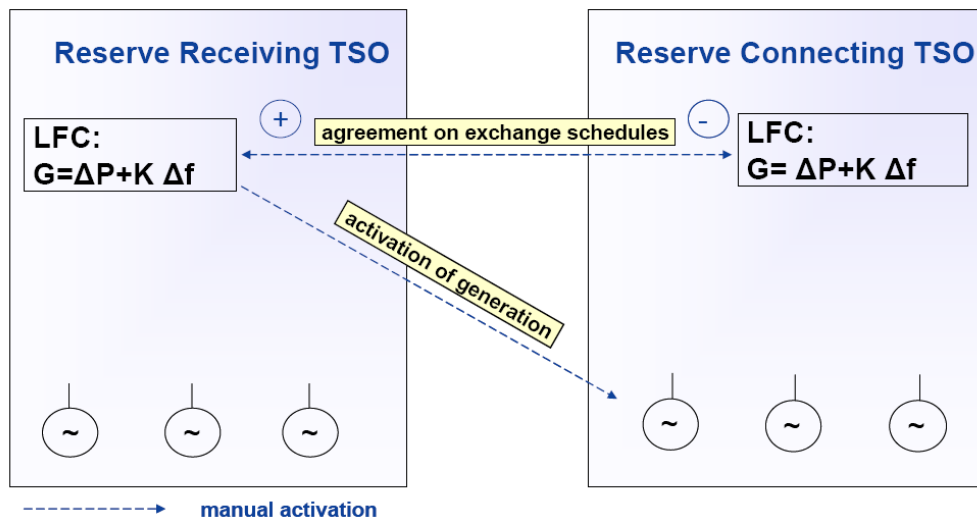

Figure 8: Direct Activation of the Generation Unit by the Reserve Receiving TSO and Delivery by Exchange Schedule

C-D2.3. Power Request by the Reserve Receiving TSO through the Reserve

Connecting TSO. The RESERVE CONNECTING TSO provides TERTIARY CONTROL RESERVE to the RESERVE RECEIVING TSO. In this case the RESERVE RECEIVING TSO has to agree with the RESERVE CONNECTING TSO on an exchange schedule, which will be used to adapt the LOAD FREQUENCY CONTROL of both the RESERVE RECEIVING TSO and the RESERVE CONNECTING TSO. The RESERVE CONNECTING TSO activates the generation from either a set of units contracted by the RESERVE RECEIVING TSO or from a set of units contracted by the RESERVE CONNECTING TSO itself.

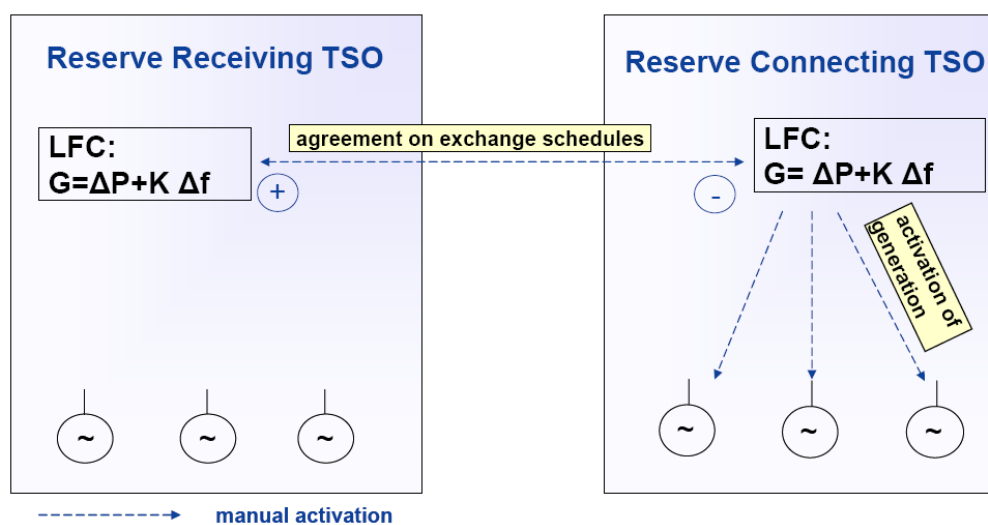

Figure 9: Power Request by the Reserve Receiving TSO through the Reserve Connecting TSO

Standards

- C-S1. Minimum Total TERTIARY CONTROL RESERVE.** Each CONTROL AREA / BLOCK has to have access to sufficient TERTIARY CONTROL RESERVE to follow up SECONDARY CONTROL after an incident. A total TERTIARY CONTROL RESERVE (sum of directly activated and schedule activated) must be available to cover the largest expected loss of power (generation unit, power infeed, DC-link or load) in the CONTROL AREA (see also “n-1” criterion in ►P3). Reserve contracts between TSOs can be a component of the required amount of TERTIARY CONTROL RESERVE.
- C-S2. Activation of TERTIARY CONTROL RESERVE:** Each TSO has to immediately activate TERTIARY RESERVE in case insufficient free SECONDARY CONTROL RESERVE is available or expected to be available.
- C-S3. Border-crossing TERTIARY CONTROL RESERVE.** TERTIARY CONTROL RESERVE can be exchanged border-crossing provided that the following requisites are met.
- C-S3.1. Fixed Share of Reserves inside the CONTROL AREA.** A fixed share of 50 % of the total needed SECONDARY CONTROL RESERVE plus TERTIARY CONTROL RESERVE must be kept inside the CONTROL AREA.

C-S3.2. Transmission Capacity. Sufficient transmission capacity must be allocated between the RESERVE RECEIVING TSO and the RESERVE CONNECTING TSO. In case one or more RESERVE TRANSITING TSOs are involved, transmission capacities across the subsequent borders must be available.

C-S3.3. Directly Activated Reserve. In the case of directly activated TERTIARY CONTROL RESERVE only “direct activation of power by the RESERVE RECEIVING TSO and transfer by measurement value” or “power request by the RESERVE RECEIVING TSO through the RESERVE CONNECTING TSO” are allowed as technical realizations.

C-S3.4. Schedule Activated Reserve. In the case of SCHEDULE ACTIVATED TERTIARY CONTROL RESERVE only “direct activation of power by the RESERVE RECEIVING TSO and transfer by exchange schedule” or “power request by the RESERVE RECEIVING TSO through the RESERVE CONNECTING TSO” are allowed as technical realizations.

C-S3.5. Data Exchange and Checking. A day-ahead data exchange about contracted reserves must be set up between the bidders and both the RESERVE CONNECTING TSO and the RESERVE RECEIVING TSO. The reserve connecting TSO has to check consistency on the basis of the available information.

Guidelines

C-G1. Activation of TERTIARY CONTROL RESERVES. TERTIARY CONTROL RESERVES should be activated within a CONTROL AREA / BLOCK by changing the generation or load within the CONTROL AREA / BLOCK. TERTIARY CONTROL RESERVES to be transferred cross-border should be transferred by updating the total EXCHANGE SCHEDULE of the corresponding CONTROL AREAS / BLOCKS (the CONTROL PROGRAM) in parallel to the activation of the-reserve.

D. Time Control

[UCTE Operation Handbook Appendix 1 Chapter D: Time Control, 2004] {update under preparation}

Introduction

The objective of TIME CONTROL is to monitor and limit discrepancies observed between SYNCHRONOUS TIME and universal co-ordinated time (UTC) in the SYNCHRONOUS AREA. Reasonably it is applied during periods of uninterrupted interconnected operation, where the SYNCHRONOUS TIME is the same in all control areas. Please refer to Appendix 1 (see ►A1-D) for basics and principles of TIME CONTROL.

Note: Some standards of this chapter only apply to one central instance in the SYNCHRONOUS AREA (instead of to all TSOs).

Definitions

- D-D1. Tolerated Range of Discrepancy.** A discrepancy between SYNCHRONOUS TIME and UTC is tolerated within a range of ± 20 seconds (without need for time control actions).
- D-D2. Target Range of Discrepancy.** The discrepancy between SYNCHRONOUS TIME and UTC is within a range of ± 30 seconds under normal conditions in case of trouble-free operation of the interconnected network.
- D-D3. Exceptional Range of Discrepancy.** Under exceptional conditions in case of trouble-free operation of the interconnected network the discrepancy between SYNCHRONOUS TIME and UTC is within a range of ± 60 seconds.
- D-D4. Time Monitor.** Central instance that monitors continuously the deviation between SYNCHRONOUS TIME and UTC.

Standards

- D-S1. Set-Point Frequency for SECONDARY CONTROL.** For TIME CONTROL purposes in the range of ►P1-D-D-D3 each CONTROL AREA (see ►P1-A) must be able to adjust the set-point frequency for SECONDARY CONTROL.
- D-S2. Mean Frequency Value.** The time monitor must ensure that the mean value (as a result of PRIMARY CONTROL, SECONDARY CONTROL and TIME CONTROL in co-operation) of the SYSTEM FREQUENCY is close to the nominal frequency value of 50 Hz (see ►P1-A-A-D1) and the TIME DEVIATION within the target range (see ►P1-D-D2).
- D-S3. Time Deviation Calculation.** The TIME DEVIATION between SYNCHRONOUS TIME and UCT has to be calculated for 8 a.m. each day by the time monitor. The relevant time

zone is the Central European Time (CET = GMT+1) with daylight saving.

D-S4. Time Correction Frequency Offset. If the TIME DEVIATION is within \gg P1-D-D-D1, the FREQUENCY OFFSET for time correction has to be set to zero. If the deviation is out of \gg P1-D-D-D1 and SYNCHRONOUS TIME is behind UTC, the FREQUENCY OFFSET has to be set to +10 mHz. If the deviation is out of \gg P1-D-D-D1 and SYNCHRONOUS TIME is ahead of UTC, the FREQUENCY OFFSET has to be set to -10 mHz. This offset is determined by the time monitor.

D-S4.1. Exceptional Time Correction Frequency Offsets. Only under exceptional conditions out of \gg P1-D-D-D3 FREQUENCY OFFSETS larger than 10 mHz (0.010 Hz) for the time correction of the SYNCHRONOUS TIME may be used. They are set by the time monitor.

D-S5. Frequency Set-point Value. The frequency set-point value has to be calculated by the time monitor out of the sum of the nominal frequency 50 Hz and the time correction FREQUENCY OFFSET and is valid for all hours of the next day, starting at 0 a.m., and is relevant for the operation of the SECONDARY CONTROL (see \gg P1-D-D-S1) and the calculation of performance criteria for SECONDARY CONTROL. All TSOs have to apply the transmitted frequency set-point value in their SECONDARY CONTROLLER for the full next day.

D-S6. Time Correction Notice. The information for the time correction has to be forwarded towards all CONTROL AREAS / BLOCKS of the SYNCHRONOUS AREA every day at 10 a.m. by the time monitor. The CONTROL AREAS / BLOCKS themselves forward this information towards their underlying CONTROL AREAS without delay.

D-S6.1. Content of Notice. Each notice has to contain the time deviation, the time correction FREQUENCY OFFSET, the time correction procedure and the date and duration for the time correction.

D-S6.2. Notice Transmission. This notice has to be transmitted using secure and reliable electronic communication that allows a half-automated procedure.

D-S7. Time Correction Serialisation. TIME DEVIATIONS and notifications on time error corrections have to be serialised by the time monitor on a quarterly basis.

Guidelines

- D-G1. Appointment of Time Monitor.** For the UCTE SYNCHRONOUS AREA UCTE appoints a time monitor (see also ►P1-D-D-D4).
- D-G2. Re-Connection of Asynchronous Areas.** Devices may need to be reset to correct time after a re-connection, when no correction is possible by time control.
- D-G3. Outstanding Notice.** In case the TIME DEVIATION and correction notice is missing for a TSO, the TSO should apply the nominal frequency of 50 Hz (see ►P1-A-A-D1) as frequency set-point value for SECONDARY CONTROL until it receives the outstanding notice and in parallel take action to receive the correct information from the time monitor.

Appendix A1-E: Operational Data

The following table lists the most important overall fixed values and annual operational data as they are used in Policy 1 and applied for system operation.

Reference	Subject	Value	dated
P1-A-D1	Nominal Frequency	50 Hz	Fixed
P1-A-D2.1	Activation of PRIMARY CONTROL	±20 mHz	Fixed
P1-A-D2.5	Full Activation of PRIMARY CONTROL RESERVES	±200 mHz	Fixed
P1-A-D3.1	Reference Incident	3000 MW	Fixed
P1-A-D4.1	SELF-REGULATION of Load	1 %/Hz	Fixed
	Highest load in the system (from 03.12.2008)	412000 MW	2009
	Contribution by SELF-REGULATION of Load	4120 MW/Hz	2009
P1-A-D4.3	Minimum NETWORK POWER FREQUENCY CHARACTERISTIC of PRIMARY CONTROL	15000 MW/Hz	Fixed
P1-A-D4.4	Average NETWORK POWER FREQUENCY CHARACTERISTIC of PRIMARY CONTROL	19500 MW/Hz	2009
	Mean generation power (in the system)	306000 MW	2009
P1-A-D4.5	SURPLUS-CONTROL OF GENERATION (50% of mean generation power in the system / 50 Hz)	3060 MW/Hz	2009
P1-A-D4.6	Overall NETWORK POWER FREQUENCY CHARACTERISTIC	26680 MW/Hz	2009
P1-A-D4.7	Overall PRIMARY CONTROL RESERVE	3000 MW	Fixed

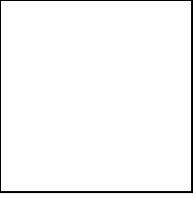

- PRELIMINARY -
internal document