



European Network of  
Transmission System Operators  
for Electricity

---

# REGIONAL COORDINATION PROCESSES DATA EXCHANGE SPECIFICATION

---

2025-02-13

---

ICTC APPROVED  
VERSION 2.3.2  
CONFIDENTIALITY CATEGORY: PUBLIC

1 Copyright notice:

2 **Copyright © ENTSO-E. All Rights Reserved.**

3 This document and its whole translations may be copied and furnished to others, and derivative  
4 works that comment on or otherwise explain it or assist in its implementation may be prepared,  
5 copied, published and distributed, in whole or in part, without restriction of any kind, provided  
6 that the above copyright notice and this paragraph are included on all such copies and  
7 derivative works. However, this document itself may not be modified in any way, except for  
8 literal and whole translation into languages other than English and under all circumstances, the  
9 copyright notice or references to ENTSO-E may not be removed.

10 This document and the information contained herein is provided on an "as is" basis.

11 **ENTSO-E DISCLAIMS ALL WARRANTIES, EXPRESS OR IMPLIED, INCLUDING BUT NOT**  
12 **LIMITED TO ANY WARRANTY THAT THE USE OF THE INFORMATION HEREIN WILL NOT**  
13 **INFRINGE ANY RIGHTS OR ANY IMPLIED WARRANTIES OF MERCHANTABILITY OR**  
14 **FITNESS FOR A PARTICULAR PURPOSE.**

15 **This document is maintained by the ENTSO-E CIM WG and relevant SOC task teams**  
16 **responsible for different business processes. Comments or remarks are to be provided**  
17 **at [cim@entsoe.eu](mailto:cim@entsoe.eu)**

18 **NOTE CONCERNING WORDING USED IN THIS DOCUMENT**

19 The force of the following words is modified by the requirement level of the document in which  
20 they are used.

- 21 • **SHALL:** This word, or the terms "REQUIRED" or "MUST", means that the definition is an  
22 absolute requirement of the specification.
- 23 • **SHALL NOT:** This phrase, or the phrase "MUST NOT", means that the definition is an  
24 absolute prohibition of the specification.
- 25 • **SHOULD:** This word, or the adjective "RECOMMENDED", means that there may exist valid  
26 reasons in particular circumstances to ignore a particular item, but the full implications must  
27 be understood and carefully weighed before choosing a different course.
- 28 • **SHOULD NOT:** This phrase, or the phrase "NOT RECOMMENDED", means that there may  
29 exist valid reasons in particular circumstances when the particular behaviour is acceptable  
30 or even useful, but the full implications should be understood and the case carefully weighed  
31 before implementing any behaviour described with this label.
- 32 • **MAY:** This word, or the adjective "OPTIONAL", means that an item is truly optional.

33

34

## Version Notes

35 This document is release 2.3 of the Regional Coordination Processes Data Exchange  
36 Specification (RCP DES). It covers the latest v2.3 profile updates, and v2.2 or v2.1 of those  
37 that have been stable since their publication.

38 The document is significantly updated to include explanations on different used cases. Section  
39 7 was rewritten to describe more details and provide CIMXML snippets. Section 8 was updated  
40 to align with changes on metadata, common data and reference data. Section 10 is new and  
41 provides guidelines on conformity assessment scheme that will need to be developed to validate  
42 the implementation of RCP DES and related data exchange profiles. On request by SOC StG  
43 REC the document was renamed to Network codes data Exchange Specification to envision  
44 that it will cover specifications and implementation guidance for all business processes. SOC  
45 confirmed the proposal to widen the content of the document and approved new document title  
46 "Regional Coordination Processes Data Exchange Specification". Currently CSA is the main  
47 business process that is covered in the document.

48 This version of the document was reviewed in Feb-Mar 2024 by CSA CC TT, CIM WG, regions  
49 and experts contributing to the document development. The approval process included the  
50 endorsement of the Steering Group Regional Coordination and a cross-Committee approval by  
51 the ICTC (on lead) and the System Operation Committee as consulted Committee. This  
52 document and its subsequent revisions will be also used for standard vetting interoperability  
53 tests. Therefore, it is considered a public document.

54 In this version of the NC profiles, based on ICTC decision to prepare for resolvable URL, the  
55 namespaces of the profiles and canonical model were changes as follows:

- 56 • NC namespace from <http://entsoe.eu/ns/nc#> to <https://cim4.eu/ns/nc#> (persistent  
57 between versions of extensions)
- 58 • CIM namespace from <http://iec.ch/TC57/CIM100#> to <https://cim.ucaiug.io/ns#> (persistent  
59 between versions of canonical CIM model)
- 60 • EU extensions from <http://iec.ch/TC57/CIM100-European#> to <https://cim.ucaiug.io/ns/eu#>  
61 (persistent between versions of extensions)
- 62 • Profile version identifiers follow the pattern {application profile subdomain}/{profile  
63 name}/{profile version, only major and minor} (e.g. <https://ap.cim4.eu/Contingency/2.3>)

64 The rationale for these changes is:

- 65 • to use the https instead of http
- 66 • to make them resolvable
- 67 • to use the new cim4.eu domain
- 68 • to identify that it is a "profile" and be able to make resolvable all artifacts related to a  
69 profile
- 70 • to align with IEC in the use of subdomains and the new persistent CIM namespace

71 The document was additionally updated to incorporate the agreements from SV-IOP held in  
72 July 2024. Updates are limited to the scope of a patch release. The rest of identified issues are  
73 scheduled for the next release. For additional details on the previous versions of the document,  
74 please refer to [section 11 \(Document Revision History\)](#).

75	<b>CONTENTS</b>		
76	Copyright notice:.....		2
77	Version Notes .....		3
78	CONTENTS .....		4
79	1 Introduction .....		8
80	2 Network Codes Profiles General Implementation Guidance .....		9
81	3 References .....		10
82	3.1 Legal References .....		10
83	3.2 Normative References .....		10
84	3.3 Specification Documents References .....		11
85	3.4 Other References.....		11
86	4 Terms and Definitions.....		12
87	5 Abbreviated Terms .....		17
88	6 CSA Business Process Overview.....		18
89	6.1 Introduction.....		18
90	6.2 Use Cases .....		21
91	6.3 Sequence Diagram .....		24
92	7 CSA Subprocesses.....		28
93	7.1 Input Data Preparation .....		28
94	7.1.1 Description .....		28
95	7.1.2 Inputs and Outputs .....		28
96	7.1.3 Input Data Design.....		29
97	7.1.4 Conformity Requirements .....		31
98	7.1.5 List of Assessed Elements .....		31
99	7.1.6 Contingency List .....		44
100	7.1.7 List of Remedial Actions .....		50
101	7.1.8 List of SPS .....		70
102	7.1.9 List of System Constraints .....		74
103	7.1.10 Define scope of the analysis .....		77
104	7.2 Regional Security Assessment.....		77
105	7.2.1 Description .....		77
106	7.2.2 Inputs and Outputs .....		77
107	7.2.3 Conformity Requirements .....		78
108	7.3 Remedial Action Optimization .....		78
109	7.3.1 Description .....		78
110	7.3.2 Inputs and Outputs .....		78
111	7.3.3 Conformity Requirements .....		79
112	7.3.4 Proposed Remedial Action Schedule .....		79
113	7.4 Remedial Action Coordination .....		80
114	7.4.1 Description .....		80
115	7.4.2 Inputs and Outputs .....		82
116	7.4.3 Conformity Requirements .....		82
117	7.4.4 Remedial Action Schedule – After Coordination .....		82
118	7.4.5 Remedial Action Schedule – Grouping.....		82

119	7.5	Final Validation .....	84
120	7.5.1	Description .....	84
121	7.5.2	Inputs and Outputs .....	84
122	7.5.3	Conformity Requirements .....	86
123	8	Application profile specification .....	87
124	8.1	General.....	87
125	8.2	Dataset Dependency .....	88
126	8.2.1	Dataset Metadata (Header).....	89
127	8.3	Compatibility with Other Data Exchange Standards.....	89
128	8.4	Common and Reference Data .....	91
129	8.4.1	Common Data.....	91
130	8.4.2	Reference Data .....	92
131	8.5	Dataset Distribution .....	94
132	8.5.1	Manifest .....	94
133	8.5.2	File Naming .....	94
134	8.5.3	Serialisation Syntax .....	94
135	8.5.4	Exchange and Packaging .....	94
136	8.6	Dataset Validation.....	95
137	9	Dependencies Between Business Processes .....	96
138	10	Conformity Assessment Scheme Setup Guidelines .....	96
139	10.1	Application Functions .....	96
140	10.2	Test Configurations.....	98
141	10.2.1	Requirements .....	98
142	10.2.2	Types .....	99
143	10.3	Test Use Cases .....	100
144	10.3.1	TUC 1: Exchange of Initial Information.....	100
145	10.3.2	TUC 2: Perform Regional Security Analysis and Export	
146		Results .....	101
147	10.3.3	TUC 3: Perform RAO and Export Results, perform	
148		Coordination and Export results .....	101
149	11	Annex A: Document Revision History.....	101
150			
151		<b>List of figures</b>	
152		Figure 1 – Day-ahead process, steps and timings (for information only).....	19
153		Figure 2 - Intraday process, steps and timings (for information only) .....	20
154		Figure 3 – Detailed BPMN for day-ahead process (for information only).....	20
155		Figure 4 - Use Cases .....	21
156		Figure 5 – CSA inputs Sequence diagram .....	24
157		Figure 6 - CSA general sequence diagram.....	26
158		Figure 7 – Input Data Preparation .....	28
159		Figure 8 –List of Assessed Elements provision .....	31
160		Figure 9 – Network element category diagram .....	32
161		Figure 10 – Secured Assessed Element example.....	33

162	Figure 11 – Scanned Assessed Element example .....	34
163	Figure 12 – Example Disable Assessed Element via SIS dataset .....	35
164	Figure 13 – Exclude Assessed Element example. ....	36
165	Figure 14 – Assessed Element with Contingency – Scenario 1.....	38
166	Figure 15 – Assessed Element with Contingency – scenario 2. ....	39
167	Figure 16 – Assessed Element with Contingency – scenario 3. ....	40
168	Figure 17 – Assessed Element with Remedial Action. ....	42
169	Figure 18 – Contingency list provision .....	44
170	Figure 19 – Contingency category diagram .....	45
171	Figure 20 – Ordinary Contingency.....	45
172	Figure 21 - Exceptional Contingency.....	47
173	Figure 22 - Out of Range Contingency .....	49
174	Figure 23 – List of Remedial Actions provision.....	50
175	Figure 24 – Remedial action state diagram .....	51
176	Figure 25 - Grid State Alteration (Tap Position) Example .....	53
177	Figure 26 - Grid State Alteration (Topology) Example .....	54
178	Figure 27 - Power Remedial Action Example with PowerSchedule .....	57
179	Figure 28 - Power Remedial Action Example with PowerBidSchedule .....	58
180	Figure 29 - Redispatch Remedial Action Example Option 3.....	60
181	Figure 30 - Redispatch Remedial Action Example Option 4.....	61
182	Figure 31 - Availability Schedule Remedial Action Example .....	63
183	Figure 32 – Remedial Action with Dependencies – HVDC case.....	64
184	Figure 33 – Remedial Action with Contingency .....	66
185	Figure 34 – SIPS overview.....	70
186	Figure 35 – SIPS Monitoring of a Line and Actions on Topology and HVDC .....	73
187	Figure 36 – Voltage Angle Limit .....	74
188	Figure 37 – Power Transfer Corridor.....	75
189	Figure 38 – Power Transfer Corridor – using Terminals .....	76
190	Figure 39 – Regional Security Assessment. ....	77
191	Figure 40 – Remedial Action Optimization.....	78
192	Figure 41 – Proposed Remedial Action Schedule – Grid Intensity .....	79
193	Figure 42 – Remedial Action Coordination .....	81
194	Figure 43 – Remedial Action Schedule Relationship without using the Group .....	83
195	Figure 44 – Remedial Action Schedule Relationship within a Group.....	83
196	Figure 45 – Final Validation session .....	84
197	Figure 46 – Dataset dependencies.....	89
198		
199	<b>List of tables</b>	
200	Table 1 – Document versions.....	11
201	Table 2 - Role labels and descriptions .....	22

202	Table 3 - CSA use cases .....	22
203	Table 4 – Inputs and Outputs for Input Data Preparation .....	29
204	Table 5 – Illustration of input data combinations for enabling of an AssessedElement .....	30
205	Table 6 – Expected Use Cases Related to Assessed Element .....	43
206	Table 7 – Expected Use Cases Related to Remedial Action. ....	66
207	Table 8 – Expected Use Cases Related to SPS Remedial Action. ....	73
208	Table 9 – Inputs and Outputs for Regional Security Assessment .....	78
209	Table 10 – Inputs and Outputs for Remedial Action Optimization .....	78
210	Table 11 – Inputs and Outputs for Remedial Action Coordination .....	82
211	Table 12 – Inputs and Outputs for Final Remedial Action Validation .....	84
212	Table 13 – Serialisation options .....	94
213	Table 14 – Application functions .....	96
214	Table 15 – Test configurations .....	99
215		

## 216 1 Introduction

217 The Regional Coordination Processes Exchange Specification (RCP DES) describes the  
218 framework for data exchange in business processes utilizing Network Nodes data exchange  
219 profiles. The specified business processes encompass Coordinated Security Analysis (CSA),  
220 Outage Planning Coordination (OPC), Coordinated Capacity Calculation (CCC), and Short-  
221 Term Adequacy (STA). The current iteration of the document predominantly centres on CSA,  
222 serving as the first business process to use Network Codes data exchange profiles.

223 Regular updates to the document will be undertaken to align with the evolution of data exchange  
224 profiles and advancements in various business processes. The core objective of the RCP DES  
225 is to establish a standardized data exchange based on the Network Codes profiles, thereby  
226 mitigating IT implementation costs and fostering interoperability among Transmission System  
227 Operators (TSOs) and Regional Coordination Centres (RCCs). The intent is to empower  
228 software vendors to create IT applications for TSOs and RCCs that facilitate seamless  
229 information exchange across all relevant business processes.

230 Furthermore, the RCP DES offers guidance on modelling diverse use cases and defines  
231 requirements for conformity assessment. These elements are crucial for business stakeholders,  
232 providing them with the necessary framework to steer the implementation of data exchange  
233 within a business process. In essence, the RCP DES seeks to streamline and enhance the  
234 efficiency of data exchange in the realm of TSOs and RCCs.

235 This document defines a structured way of exchanging the following data:

- 236 • Remedial action
- 237 • Assessed element
- 238 • Contingency
- 239 • SIPS configuration
- 240 • Security limits and system constraints
- 241 • Generation and load shift keys (GLSK)
- 242 • Power transfer corridor (PTC)
- 243 • Steady state instructions
- 244 • Remedial action schedule (to exchange proposed, accepted/rejected, activated  
245 remedial action)
- 246 • Security analysis result
- 247 • Impact assessment matrix
- 248 • Remedial action sensitivity matrix
- 249 • The redispatch and countertrading cost sharing (in accordance with CACM Article 74(7))

250  
251 Next releases of the specification will focus on the following items:

- 252 • Coverage of other business processes such as OPC, CCC, Regional STA
- 253 • CSA methodology amendment, if any impacting changes
- 254 • .

255 The following is out of scope of the current version of the specification:

- 256 • The reporting and the monitoring of the CSA (pursuant to SOGL article 17)
- 257 • The Probabilistic Risk Assessment (pursuant to Article 44(4) of CSAm)

258

259 The following should be taken into account when reading the document:

- 260 • Not all use cases are covered in the current version of the specification. The document  
261 contains “Expected Use Cases” that can be specified in next versions of the  
262 specification in an addition to any other proposed use cases.
- 263 • Code snippets are only provided to illustrate and help the implementation. The code  
264 provided is not completely functional as it is only small part that focuses on the



- 265 presented use case. It could also be the case that not all required attributes are  
266 provided.
- 267 • Code snippets refer to identifiers that are only used to explain the relationship, i.e. in  
268 most cases identifiers are random UUID or strings that shall not be referred as a  
269 reference in any implementations of Network Codes profiles. The correct identifiers are  
270 to be provided from common and reference data.
  - 271 • Business Process Model Notation (BPMN) diagrams are taken from the Inter-RSC  
272 report<sup>1</sup>. The BPMN diagrams are accompanied with a table describing the “Inputs” and  
273 “Outputs” of the process. The business terms used in the Inter-RSC report cannot be  
274 linked directly to the terms used in the NC profile specifications and RCP DES.

## 275 2 Network Codes Profiles General Implementation Guidance

276 During the developmental and implementation phases of NC Profiles and RCP DES, numerous  
277 activities involve amending methodologies and introducing Regional Operational Security  
278 Coordination (ROSC) processes. The progression of these activities necessitates alignment  
279 with data exchange profiles, specifications, and guidance. To facilitate the implementation of  
280 these complex business processes and related data exchanges, the following general  
281 implementation guidance is provided:

- 282 • **Individual Release and Versioning:** Network Codes profiles will not be bundled as a  
283 package; instead, they will be released individually. Each profile and its accompanying  
284 documentation will adhere to [Semantic Versioning 2.0.0](#). For instance, an exchange  
285 may utilize RCP DES v2.3.0, Equipment Reliability profile v2.2.0, and Remedial Action  
286 Profile v2.3.0. Development will carefully manage dependencies between profiles and  
287 ensure that all profiles designed to be compatible use the same namespaces and are  
288 derived from the same version of the canonical model. RDCP DES version will be  
289 updated every time one of the profiles is changed.
- 290 • **Frequent RCP DES Updates:** RCP DES will undergo frequent updates to incorporate  
291 additional clarifications, use cases, and coverage of new business processes.
- 292 • **Transition:** Business processes should ensure that there is a transition plan to support  
293 the transition between versions of different NC profiles and specifications.
- 294 • **Understanding Power System Model Dependencies:** Implementing parties (TSOs,  
295 RCCs, CCRs, Vendors, etc.) must be aware of dependencies and capabilities related to  
296 modelling the power system model (IGM/CGM) using the IEC CGMES set of profiles.  
297 The evolving nature of NC profiles and business requirements requires corresponding  
298 advancements in the CGMES set of profiles.
- 299 • **Feedback and Standard Vetting Interoperability Tests:** Both NC profiles and RCP  
300 DES will rely on feedback collected in Standard Vetting Interoperability Tests organized  
301 by ENTSO-E annually. This practice aims to enhance the maturity of data exchange  
302 specifications and support ongoing implementation efforts.
- 303 • **Machine-Readable Artifacts and Namespace/Versioning Information:** Implementors  
304 should rely on machine-readable artifacts provided with NC profiles and be prepared for  
305 multiple<sup>2</sup> or frequently changing namespace information for different data objects.  
306 Changes will be controllable to minimize impacts, with an understanding that these  
307 profiles will be proposed as international CIM standards in the coming years. Changes  
308 can also happen due to the implementation of common data and reference data (refer  
309 to section 8.4) together with the implementation of better approaches to handle metadata  
310 between or within different business processes.
- 311 • **Persistent Identifiers:** Increased complexity in data exchanges, such as  
312
  - detailed power system modelling,
  - substantial additional information exchange mandated by EU Network Codes,
313

<sup>1</sup> Report on Inter-RCC and Inter-CCR Coordination for Coordinated Regional Security Analyses V1.2

<sup>2</sup> Multiple namespaces are used in the datasets and in profiles. CIM namespace, ENTSO-E namespace, NC namespace, W3C DCAT namespace, etc.

- 314           ○ shared data sets across multiple business processes,  
315           ○ the dependency on the timeframes,  
316           ○ requirements on reporting within business processes and towards external  
317 parties such as ACER, etc.,

318 requires the implementation of persistent identifiers. This approach optimizes data  
319 exchange by transmitting only the most relevant information. Therefore, IT and business  
320 implementations should align with this vision.

- 321 • **Data Validation:** Development of Data Quality Management Provisions is required by  
322 CSAm Art 42(1) and it will be prepared by June 2024 as part of the Regional  
323 Coordination Processes Data Quality Management Provisions (RCP DQMP) document.  
324 This document will define the data validation framework and business specific  
325 constraints (consistency rules) that apply for all regions or are regions specific. Standard  
326 or specification related constraints will be part of the NC profiles. Therefore, when data  
327 validation is performed it will rely on constraints defined in NC Profiles specifications  
328 and in the NC DQMP document. NC DQMP constraints will not contradict the standard  
329 NC profile constraints or extend the profiles or canonical model. The constraints will  
330 only be more restrictive with the aim of improving data quality and satisfy the business  
331 requirements on data consistency as defined in the methodologies.

332 The overarching goal is to facilitate a seamless and efficient implementation of NC Profiles and  
333 RCP DES, ensuring adaptability to evolving requirements and interoperability across diverse  
334 stakeholders.

### 335 3 References

#### 336 3.1 Legal References

- 337 • [Commission Regulation \(EU\) 2017/1485 of 2 August 2017 establishing a guideline on](#)  
338 [electricity transmission system operation \(SOGL\);](#)
- 339 • [Commission Regulation \(EU\) 2015/1222 of 24 July 2015 establishing a guideline on](#)  
340 [capacity allocation and congestion management \(CACM\);](#)
- 341 • [All TSOs' proposal for a methodology for coordinating operational security analysis in](#)  
342 [accordance with Article 75 of Commission Regulation \(EU\) 2017/1485 of 2 August 2017](#)  
343 [establishing a guideline on electricity transmission system operation \(CSA](#)  
344 [methodology\);](#)
- 345 • [Regulation \(EU\) 2019/943 of the European Parliament and of the Council of 5 June 2019](#)  
346 [on the internal market for electricity \(Clean Energy Package\).](#)

#### 347 3.2 Normative References

348 The following documents, in whole or in part, are normatively referenced in this document and  
349 are indispensable for its application. For dated references, only the edition cited applies. For  
350 undated references, the latest edition of the referenced document (including any amendments)  
351 applies.

- 352 • [IEC 61970-301:2021 Energy management system application program interface \(EMS-](#)  
353 [API\) - Part 301: Common information model \(CIM\) base;](#)
- 354 • [IEC 61970-600-1:2021 Energy management system application program interface](#)  
355 [\(EMS-API\) - Part 600-1: Common Grid Model Exchange Standard \(CGMES\) - Structure](#)  
356 [and rules;](#)
- 357 • [IEC 61970-600-2:2021 Energy management system application program interface](#)  
358 [\(EMS-API\) - Part 600-2: Common Grid Model Exchange Standard \(CGMES\) - Exchange](#)  
359 [profiles specification;](#)
- 360 • [IEC 61968-11:2013 Application integration at electric utilities - System interfaces for](#)  
361 [distribution management - Part 11: Common information model \(CIM\) extensions for](#)  
362 [distribution](#)

363

364 **3.3 Specification Documents References**

365 The following specification documents, in whole or in part, are referenced in this document and  
366 are indispensable for its application. For dated references, only the edition cited applies. For  
367 undated references, the latest edition of the referenced document (including any amendments)  
368 applies.

369 Not all profiles are related to a single business process. The usage of the profiles depends on  
370 the needs to the business process and covered use cases.

371 Table 1 specifies the versions of the referenced RCP documents that are considered in the current  
372 version of the RCP DES. The version of the RCP DES will be updated any time the versions of  
373 the referenced documents change.

374 **Table 1 – Document versions**

Document	Version
ENTSO-E Assessed element profile specification	2.3.1
ENTSO-E Availability schedule profile specification	2.3.1
ENTSO-E Contingency profile specification	2.3.1
ENTSO-E Equipment reliability specification	2.3.2
ENTSO-E Impact assessment matrix profile specification	2.3.1
ENTSO-E Monitoring area profile specification	2.3.1
ENTSO-E Object registry profile specification	2.2.1
ENTSO-E Power schedule profile specification	2.3.1
ENTSO-E Power system project profile specification	2.3.1
ENTSO-E Remedial action profile specification	2.3.2
ENTSO-E Remedial action schedule profile specification	2.3.2
ENTSO-E Security analysis result profile specification	2.4.0
ENTSO-E Sensitivity matrix profile specification	2.3.1
ENTSO-E State instruction schedule profile specification	2.3.2
ENTSO-E Steady state hypothesis schedule profile specification	1.0.2
ENTSO-E Steady state instructions profile specification	2.3.2
ENTSO-E Metadata for dataset and distribution specification	2.4.0
ENTSO-E Boundary and reference data exchange application specification	1.0.0

376

377

378 **3.4 Other References**

- 379
- 380 • [The Harmonised Electricity Market Role Model](#);
  - 381 • Report on Inter-RCC and Inter-CCR Coordination for Coordinated Regional Security Analyses V1.2
  - 382 • CSA Coordination Function – Business Requirements Specification v1.0
  - 383 • CSA Input Data Consistency Function – Business Requirements Specification v1.0
  - 384 • CSA Data Classification v1.0
  - 385 • CGM-RCC Users Group - Business Requirements Specification v1.0
  - 386 • CGMES profiling user guide v1.0.

## 387 4 Terms and Definitions

### 388 4.1 Agreed remedial action

389 Agreed remedial action means a cross-border relevant remedial action for which TSOs in a  
390 region agreed to implement or any other remedial action for which TSOs have agreed that it  
391 does not need to be coordinated.

392 [SOURCE: CSAm art. 2.1.19]

### 393 4.2 Assessed element

394 Assessed element is a network element for which the electrical state is evaluated in the regional  
395 or cross-regional process and which value is expected to fulfil regional rules function of the  
396 operational security limits.

397 Where necessary, for defining the regional or cross-regional rules for ensuring the system  
398 security, assessed elements can be subdivided into two sub-classes – secured elements and  
399 scanned elements.

400 [SOURCE: 2019 Inter-RSC report, BRS CAS consistency function, 4.1]

### 401 4.3 Availability schedule

402 A given availability schedule with a given status and cause that include multiple equipment that  
403 need to follow the same scheduling periods

404 [SOURCE: CSA project group]

### 405 4.4 Available remedial action

406 Available remedial action is a remedial action which is available to solve identified constraints.  
407 It includes the needed technical and cost information.

408 [SOURCE: 2019 Inter-RSC report]

### 409 4.5 Capacity Calculation Region

410 Capacity Calculation Region (CCR) means the geographic area in which coordinated capacity  
411 calculation is applied.

412 [SOURCE: CACM art.2.3]

### 413 4.6 Common Grid Model (CGM)

414 Common Grid Model (CGM) means a Union-wide data set agreed between various TSOs  
415 describing the main characteristic of the power system (generation, loads and grid topology)  
416 and rules for changing these characteristics during the coordinated capacity calculation  
417 process.

418 [SOURCE: CACM art.2.2]

### 419 4.7 Constraint

420 Constraint means a situation in which there is a need to prepare and activate a remedial action  
421 in order to respect operational security limits.

422 [SOURCE: SOGL art.3.2.2]

### 423 4.8 Contingency

424 Contingency means the identified and possible or already occurred fault of an element,  
425 including not only the transmission system elements, but also significant grid users and  
426 distribution network elements if relevant for the transmission system operational security.

427 [SOURCE: CACM art.2.10]

428 **4.9 Contingency analysis**

429 Contingency analysis means a computer-based simulation of contingencies from the  
430 contingency list.

431 [SOURCE: SOGL art.3.2.27]

432 **4.10 Contingency list**

433 Contingency list means the list of contingencies to be simulated in order to test the compliance  
434 with the operational security limits.

435 [SOURCE: SOGL art.3.2.4]

436 **4.11 Countertrading**

437 Countertrading means a cross zonal exchange initiated by system operators between two  
438 bidding zones to relieve physical congestion.

439 [SOURCE: Reg 2019/943 art.2.27]

440 **4.12 Critical Network Element (CNE)**

441 Critical network element means a network element either within a bidding zone or between  
442 bidding zones taken into account in the capacity calculation process, limiting the amount of  
443 power that can be exchanged.

444 [SOURCE: Reg 2019/943 art.2.69]

445 **4.13 Coordinated regional operational security assessment (CROSA)**

446 Coordinated regional operational security assessment (CROSA) means an operational security  
447 analysis performed by RCCs on a common grid model on a regional level.

448 [SOURCE: SOGL art.78]

449 **4.14 Cross coordinated regional operational security assessment (CCROSA)**

450 Cross coordinated regional operational security assessment (CCROSA) means an operational  
451 security analysis performed by RCCs on a common grid model on a cross-regional level.

452 [SOURCE: ACER Decision on CSAM art. 33.e]

453 **4.15 Cross-border relevant network element' (XNE)**

454 Cross-border relevant network element' (XNE) means a network element identified as cross  
455 border relevant and on which operational security violations need to be managed in a  
456 coordinated way.

457 [SOURCE: ACER Decision on CSAM: Annex I art 2.1.8]

458 **4.16 Cross-border relevant remedial action (XRA)**

459 Cross-border relevant remedial action (XRA) means a remedial action identified as cross border  
460 relevant and needs to be applied in a coordinated way.

461 [SOURCE: CSAm art.2.1.12]

462 **4.17 Curative remedial action**

463 Curative remedial action means a remedial action that is the result of an operational planning  
464 process and is activated straight subsequent to the occurrence of the respective contingency  
465 for compliance with the (N-1) criterion, taking into account transitory admissible overloads and  
466 their accepted duration.

467 [SOURCE: CSAm art.2.1.24]

468 **4.18 Exceptional contingency**

469 Exceptional contingency means the simultaneous occurrence of multiple contingencies with a  
470 common cause.

471 [SOURCE: SOGL art.3.2.39]

472 **4.19 External contingency**

473 External contingency means a contingency outside the TSO's control area and excluding  
474 interconnectors, with an influence factor higher than the contingency influence threshold.

475 [SOURCE: SOGL art.3.2.24]

476 **4.20 Generation Shift Key**

477 A method of translating a net position change of a given bidding zone into estimated specific  
478 injection increases or decreases in the common grid model.

479 [SOURCE: CACM art.2.12]

480 **4.21 Identified constraint**

481 Identified constraint is a group of elements composed by one or more assessed elements and  
482 the contingency leading to a violation of an operational security limit or a function of this  
483 operational security limit.

484 [SOURCE: CSA project group]

485 **4.22 Impact assessment**

486 Impact assessment determines the impact of changes of a grid model on each TSO's grid and  
487 assesses whether this impact qualifies as so significant that the respective TSO is deemed  
488 "impacted" by the change.

489 [SOURCE: CSA project group]

490 **4.23 Individual Grid Model (IGM)**

491 Individual Grid Model (IGM) means a data set describing power system characteristics  
492 (generation, load and grid topology) and related rules to change these characteristics during  
493 the coordinated security analysis process, prepared by the responsible TSOs, to be merged  
494 with other individual grid model components in order to create the common grid model.

495 [SOURCE: CACM art.2.1]

496 **4.24 Individual action**

497 Individual action is an action that is one of the single remedial actions as defined in Article 22  
498 of the SO Regulation.

499 [SOURCE: CSAm art.14.2]

500 **4.25 Internal contingency**

501 Internal contingency means a contingency within the TSO's control area, including  
502 interconnectors.

503 [SOURCE: SOGL art.3.2.23]

504 **4.26 Load Shift Key**

505 It constitutes a list specifying those load that shall contribute to the shift in order to take into  
506 account the contribution of generators connected to lower voltage levels (implicitly contained in  
507 the load figures of the nodes connected to the EHV grid).

508 [SOURCE: Coordinated Capacity Calculation IG v1.0]

**509 4.27 N-situation**

510 N-situation means the situation where no transmission system element is unavailable due to  
511 occurrence of a contingency.

512 [SOURCE: SOGL art.3.2.3]

**513 4.28 N-1 situation**

514 N-1 situation means the situation in the transmission system in which one contingency from the  
515 contingency list occurred.

516 [SOURCE: SOGL art.3.2.15]

**517 4.29 Normal state**

518 Normal state means a situation in which the system is within operational security limits in the  
519 N-situation and after the occurrence of any contingency from the contingency list, taking into  
520 account the effect of the available remedial actions.

521 [SOURCE: SOGL art.3.2.5]

**522 4.30 Ordinary contingency**

523 Ordinary contingency means the occurrence of a contingency of a single branch or injection.

524 [SOURCE: SOGL art.3.2.54]

**525 4.31 Operational security analysis**

526 Operational security analysis means the entire scope of the computer based, manual and  
527 automatic activities performed in order to assess the operational security of the transmission  
528 system and to evaluate the remedial actions needed to maintain operational security.

529 [SOURCE: SOGL art.3.2.50]

**530 4.32 Out of range contingency**

531 Out of range contingency means the simultaneous occurrence of multiple contingencies without  
532 a common cause, or a loss of power generating modules with a total loss of generation capacity  
533 exceeding the reference incident.

534 [SOURCE: SOGL art.3.2.55]

**535 4.33 Overlapping zone**

536 A collection of all the overlapping cross border assessed elements which have the same sets  
537 of impacted and impacting regions.

538 [SOURCE: CSA data exchange project group]

**539 4.34 Power transfer corridor (PTC)**

540 A power transfer corridor is defined as a set of circuits (transmission lines or transformers)  
541 separating two portions of the power system, or a subset of circuits exposed to a substantial  
542 portion of the transmission exchange between two parts of the system.

543 [SOURCE: CSA data exchange project group]

**544 4.35 Preventive remedial action**

545 Preventive remedial action means a remedial action that is the result of an operational planning  
546 process and needs to be activated prior to the investigated timeframe for compliance with the  
547 (N-1) criterion.

548 [SOURCE: CSAm art.2.1.18]

**549 4.36 Proposed remedial action**

550 Proposed remedial action is a remedial action proposed by RCC after remedial action  
551 optimization or proposed by TSOs as an alternative for the Rejected RAs. RCC coordinates  
552 proposed remedial actions with affected TSOs for intra-CCR and with affected TSOs and RCC  
553 for cross-CCR.

554 [SOURCE: CSA project group]

**555 4.37 Remedial action**

556 Remedial action means any measure applied by a TSO or several TSOs, manually or  
557 automatically, in order to maintain operational security.

558 [SOURCE: CACM art.2.13]

**559 4.38 Remedial action influence factor**

560 Remedial action influence factor means a flow deviation on a XNEC resulting from the  
561 application of a remedial action, normalised by the permanent admissible loading on the  
562 associated XNE.

563 [SOURCE: CSAm art.2.1.11]

**564 4.39 Regional Coordination Centre (RCC)**

565 It means regional coordination centre established pursuant to Article 35 of Regulation 2019/943.  
566 Most RSCs evolve into RCCs on 1<sup>st</sup> July 2022.

567 [SOURCE: Regulation (EU) 2019/943 of the European Parliament and of the Council of 5 June  
568 2019 on the internal market for electricity]

**569 4.40 Regional Security Coordinator (RSC)**

570 Regional Security Coordinator (RSC) means the entity or entities, owned or controlled by TSOs,  
571 in one or more capacity calculation regions performing tasks related to TSO regional  
572 coordination.

573 [SOURCE: SOGL art.3.2.89]

**574 4.41 Restoring remedial action**

575 Restoring remedial action means a remedial action that is activated subsequent to the  
576 occurrence of an alert state for returning the transmission system into normal state again.

577 [SOURCE: CSAm art.2.1.13]

**578 4.42 Scanned element**

579 Scanned element is an assessed element on which the electrical state (at least flows) shall be  
580 computed and shall be subject to an observation rule during the regional security analysis  
581 process. Such observation rule can be for example avoiding the increase of a constraint or  
582 avoiding the creation of a constraint on this element, as a result of the design of remedial  
583 actions needed to relieve violations on the secured elements. A scanned element within a CCR  
584 can be any element of any CCR (irrespective of any potential qualification as XNE by one or  
585 more CCRs).

586 [SOURCE: CSA project group]

**587 4.43 Secured element**

588 Secured element is an assessed element on which remedial actions are identified to relief  
589 violations, when violations of an operational security limit are identified during the regional or  
590 cross-regional security analysis. On the CCR context, a secured element is an XNE.

591 [SOURCE: CSA project group]



**592 4.44 System (integrity) protection scheme**

593 System integrity protection scheme<sup>3</sup> is an automatic protection system designed to detect  
594 abnormal or predetermined system conditions and take corrective actions other than and/or in  
595 addition to the isolation of faulted components to maintain system reliability. Such actions may  
596 include changes in demand, generation or system configuration to maintain system stability,  
597 acceptable voltage or power flows.<sup>4</sup>

598 [SOURCE: [North American Electric Reliability Corporation glossary](#)]

599 Note: SOGL art.37 defines tasks to TSOs which use Special Protection Schemes

**600 4.45 System Operator**

601 A party responsible for operating, ensuring the maintenance of and, if necessary, developing  
602 the system in a given area and, where applicable, its interconnections with other systems, and  
603 for ensuring the long-term ability of the system to meet reasonable demands for the distribution  
604 or transmission of electricity.

605 [SOURCE: Harmonized Role Model based on the Directive 2009/72/EC of the European  
606 parliament and of the council of 13 July 2009 concerning common rules for the internal market  
607 in electricity and repealing Directive 2003/54/EC, Article 2 (Definitions).

**608 5 Abbreviated Terms**

609	CCR	Capacity Calculation Region
610	CGMES	Common Grid Model Exchange Standard
611	CIM	Common Information Model (electricity)
612	CROSA	Coordinated Regional Operational Security Assessment
613	CCROSA	Cross Coordinated Regional Operational Security Assessment
614	CSA	Coordinated Security Analysis
615	CSAm	Coordinated Security Analysis Methodology
616	EIC	Energy Identification Codes
617	ENTSO-E	European Network of Transmission System Operators for Electricity
618	HVDC	High Voltage Direct Current
619	IEC	The International Electrotechnical Commission
620	MAS	Model Authority Set
621	mRID	CIM Master Resource Identifier
622	MTU	Market Time Unit
623	OPC	Outage Planning Coordination
624	RAO	Remedial Action Optimization
625	RCC	Regional Coordination Centre
626	RDF	Resource Description Framework
627	RDFS	RDF Schema
628	RefHour	Reference Hour
629	RSA	Regional Security Assessment
630	SHACL	Shapes Constraint Language
631	SO	System Operator
632	SOC	ENTSO-E System Operations Committee

<sup>3</sup> The system protection scheme (SPS) can be called system integrity protection schemes (SIPS) in some CCRs (e.g. Nordic CCR)

<sup>4</sup> North American Electric Reliability Corporation glossary

633	SOGL	System Operations Guideline
634	SIPS	System Integrity Protection Scheme
635	SPS	Special Protection Scheme (often terms SIPS and SPS are used interchangeably)
636	STA	Short Term Adequacy
637	TSO	Transmission System Operator
638	UCTE DEF	Union for the Coordination of the Transmission of Electricity Data Exchange Format
639		
640	URI	Uniform Resource Identifier
641	UUID	Universally Unique Identifier
642	XML	Extensible Markup Language
643	XNE	Cross-border relevant Network Element
644	XNEC	Cross-border relevant Network Element with contingency
645	XRA	Cross-border relevant Remedial Action
646	XSD	XML Schema Definition

## 647 **6 CSA Business Process Overview**

648 This section is only informative and does not specify business requirements. Business  
649 requirements are specified in respective network codes, methodologies, or business process  
650 documents.

### 651 **6.1 Introduction**

652 The CSA is a business process defined in the CSA methodology (CSAm), as required in SOGL  
653 Article 75. Its primary objective is to uphold the security of the supply within the European  
654 electricity grid. The CSA process also includes the regional operational security coordination  
655 per CCR (as per SOGL Article 76) as well as the cross-RCC and cross-CCR Coordination  
656 (required by the SOGL article 75 and 76). Each CCR has its own regional operational security  
657 coordination (ROSC) methodology that has regional scope. Therefore, the CSA process is  
658 relying on input data from TSOs that are shared to the RCCs to perform remedial action  
659 optimisation for a CCR and in cooperation with the other CCRs. A common data specification  
660 shall ensure that each of the functions handling and storing any of the assessed data, will do it  
661 in an equally secure and adequate manner.

662 The cross-RCC Coordination is required by SOGL for RCCs when performing their tasks defined  
663 in SOGL (Art 77 to 81) at CCR level. The CSAm provides a set of requirements for TSOs and  
664 RCCs, defines the content and objectives of this cross-RCC coordination.

665 The regional and cross-regional day-ahead process major steps and timings are defined in the  
666 CSAm Article 33. When harmonising different versions of Common Grid Model Methodology  
667 (CGMM) and including additional requirements ENTSO-E agreed to define Pan-European  
668 Operational Processes Timings Framework document to define the timings of the steps for all  
669 business processes that use common datasets. This includes the mapping between timings  
670 defined in the CSAm Art 33 and the new set of harmonised timings.

671 The CSA process is divided in four phases as detailed in the Report on Inter-RSC and Inter-  
672 CCR coordination for CSA. The T0 to T5 notation is used in the CSAm and the present CGMM  
673 versions. However, updates of CGMM and alignment on the timings between different business  
674 processes can change these notations. The information provided here is only for information to  
675 facilitate the reading of the document.

- 676 • **Preparation phase (before T0):** This corresponds to the preparation of the SOs' IGMs  
677 and of all relevant information (updates of available remedial actions, contingencies,  
678 etc.).
- 679 • **Coordination Run 1 phase (from T0 to T2):** This includes steps of the CGM Build  
680 process which provides the CGM for 24 hours of next day and the CROSA process  
681 related to regional and cross regional security analyses (contingency analysis, remedial  
682 action optimization, coordination) and its possible loops.
- 683 • **Coordination Run 2 phase (from T2 to T4):** The second coordination run is performed  
684 to evaluate the combined effects of all remedial actions preliminary agreed in the first  
685 one and to improve/correct where necessary. It also enables benefit from updated  
686 forecasts. This coordination run includes steps to provide an updated CGM (for 24 hours  
687 of next day, based on updated IGMs) which considers all agreed preventive remedial  
688 actions, agreed curative remedial actions, new forecasts, any other changes to the  
689 inputs updated and shared from T2 to T3. When CGM is available (max at T3) to T4: all  
690 the phases of regional and cross-regional security analyses (contingency analysis,  
691 remedial action optimization, coordination) and its possible steps are performed.
- 692 • **Final Validation phase (from T4 to T5):** According to Art. 31(1)(f) of CSAm, during the  
693 final validation session, TSOs and RCCs shall consolidate the final outcomes of the  
694 whole process in a common teleconference involving also the TSOs from impacting  
695 CCRs. TSOs shall evaluate the Agreed RAs, in application of Article 78(4) of the SO  
696 Regulation. Each TSO shall participate in this session or shall appoint its RCC to  
697 represent it at the session while the TSO keeps the legal responsibility to agree on RAs.

698

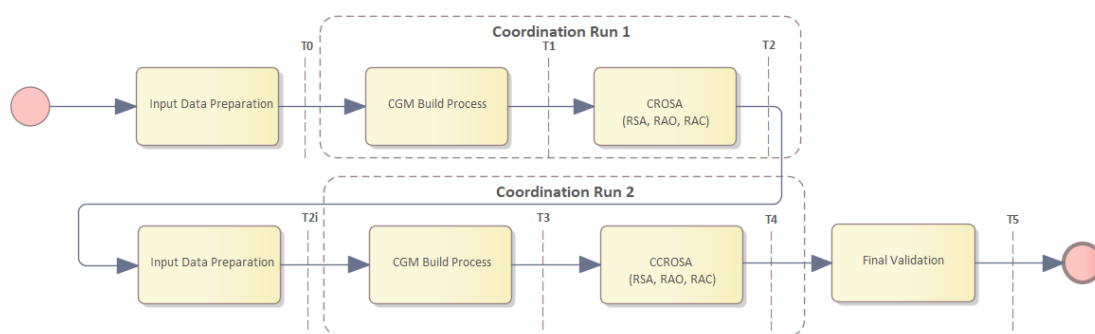

699

**Figure 1 – Day-ahead process, steps and timings (for information only)**

700  
701

702 Each coordination run includes the building of a CGM model, a regional security analysis and  
703 remedial action optimization with a cross-RCC and cross-CCR coordination. Figure 1 depicts  
704 the target CSA process that is expected to be implemented across all CCRs in the end.  
705 However, this document uses this only to provide background information and not to specify  
706 the process. The design and sequence of subprocesses including timings are governed in  
707 separate documents that are kept aligned with modifications in CGMM, CSAm and  
708 implementation timelines of ROSC process in each CCR. For example, until inter-CCR process  
709 is implemented, ROSC process shall include only single CGM build process in Day-ahead  
710 timeframe.

711 For intraday process, steps and timings are described below.

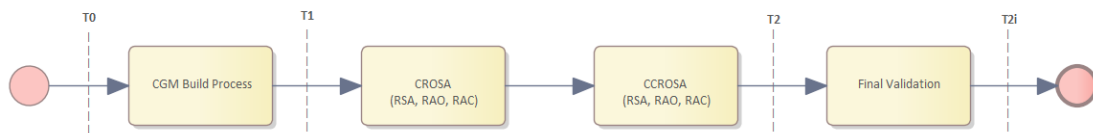

**Figure 2 - Intraday process, steps and timings (for information only)**

712  
713  
714

715 • **Preparation phase:** The IGMs are made available for the following hours, at least from  
716 RefHour +1 until RefHour +9 (and preferably until end of the day). The CGM Build  
717 process provides the CGM.

718 • **From T1 to T2:** The regional and cross-regional process are executed.

719 • **From T2 to T3:** The intraday final validation is executed.

720  
721  
722

Detailed business process (BPMN) for the day-ahead CSA process.

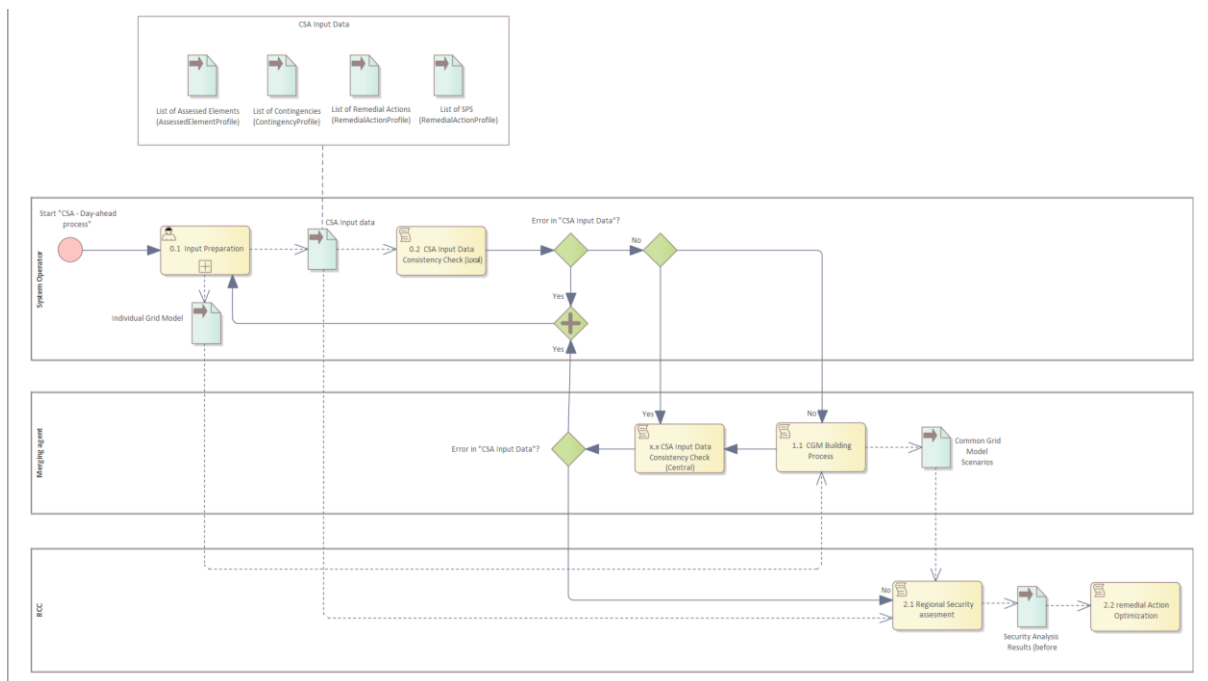

**Figure 3 – Detailed BPMN for day-ahead process (for information only)**

723  
724  
725

726 **6.2 Use Cases**

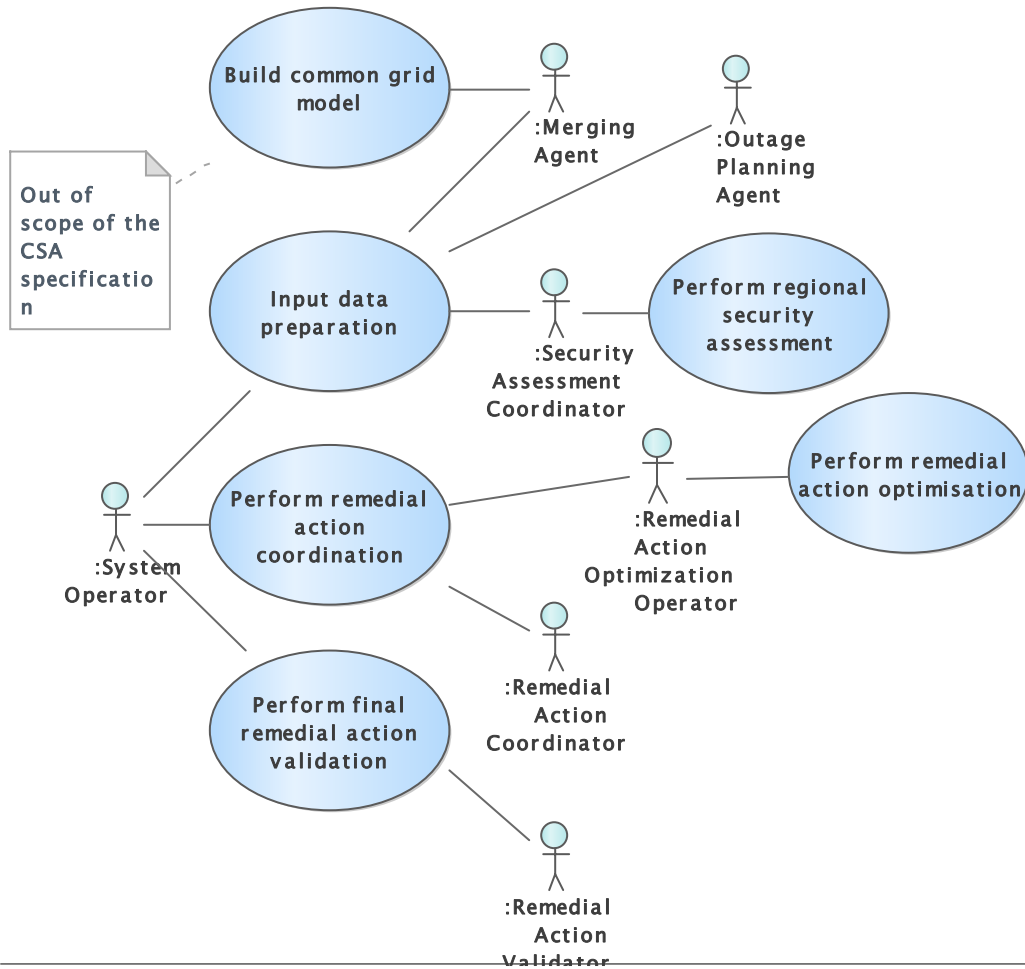

727

728

**Figure 4 - Use Cases**

729 Table 2 gives a list of roles involved in the business processes. Some of these roles such as  
730 Outage Planning Agent are not strictly part of CSA process.

731 **Table 2 - Role labels and descriptions**

Role Label	Role Description
Merging Agent	The Merging Agent is responsible to gather the IGMs from SOs and build the CGM. The Merging Agent provides the CGM to the security assessment coordinator, who uses it as an input to perform the security analysis.
Outage Planning Agent	Outage Planning Agent provides the availability plan to the security assessment coordinator who uses this in case a remedial action would be the cancellation or shortening of an outage plan.
System Operator	SO provides most of the needed inputs to perform the security analysis. This role also participates in the remedial action coordination agreeing or rejecting the remedial actions.
Security Assessment Coordinator	The Security Assessment Coordinator performs the security assessment against contingencies in order to identify potential congestions in the grid and propose to the SO a set of remedial actions to solve the found issues.
Remedial Action Optimization Operator	Remedial Action Optimization Operator performs the remedial action optimization based on security assessment result before RAO and remedial actions defined as part of the structural data.
Remedial Action Coordinator	The Remedial Action Coordinator main task is to get the agreement on all proposed remedial actions identified by the remedial action optimization step and potentially any additional remedial actions specifically requested by a SO.
Remedial Action Validator	The main activity of the Remedial Action Validator during the final validation session is to review unresolved relevant identified constraints (on assessed elements), discuss/find possible follow-up activities by TSOs and RCCs and deliver the conclusions.

732 Table 3 gives a list of use cases for the CSA business process.

733 **Table 3 - CSA use cases**

Use case label	Roles involved	Action descriptions and assertions
Input data preparation	SO, Merging Agent, Outage Planning Agent, Security Assessment Coordinator	In order to allow the representation of the grid as well as the proper assessment of its security and the identification of potential effective and efficient remedial actions for the mitigation of identified constraints, the SO shall provide the list of assessed elements, contingencies, remedial action (including SIPS) and equipment reliability (e.g. Power transfer Corridor, reliability limits, etc), scheduled data and per market time unit data. Optionally Generation and Load Shift keys can be provided. SO shall provide as well its IGM to the Merging Agent, who builds the CGM as input to the business processes. Outage Planning Agent provides the availability plan. Finally, the security assessment coordinator performs a business check on all the received data.

Build common grid model	Merging Agent	Merging agent builds the CGM as the comprehensive aggregation and calculation on the basis of the IGMs and some relevant additional input data (e.g. boundary information, common data, reference data); this is out of the scope of this document and part of the CGM Build Process.
Perform regional security assessment	Security Assessment Coordinator	The Security Assessment Coordinator performs the security assessment against contingencies to identify potential congestions in the grid. This security assessment is run according to rules defined in the CCR Article 76 methodology (at least flows and potentially other aspects of security).
Perform remedial action optimization	Remedial Action Optimization Operator	The Remedial Action Optimization Operator performs the remedial action optimization to select the most suitable remedial actions to operate the network efficiently while ensuring security of supply.
Perform remedial action coordination	SO, Remedial Action Optimization Operator, Remedial Action Coordinator.	The Remedial Action Coordination is divided in two steps. The first step consists of managing the interactions within the CCR. The purpose is to apply rules (According to CSAm Art. 27) to address the cross-impacts between CCRs on the overlapping zones. In the second step, the impact assessment of all proposed and adjusted remedial actions is performed. This impact assessment consists of identifying the affected SOs for each remedial action, based on the rules defined in the CCR Article 76 methodology (qualitative and/or quantitative rules) and rules for cross-CCR impact (to be defined according to the amendment of CSAm Article 27).
Perform final remedial action validation	Remedial Action Validator, SO	The main activity during the final validation session is to review unresolved relevant identified constraints (on assessed elements), discuss/find possible follow-up activities by SO and Remedial Action Validator and record the conclusions. Remedial Action Validator shall provide the results and decisions to the SO.

734

735

736  
737 **6.3 Sequence Diagram**

738 Figure 5 shows a sequence diagram with the inputs of the CSA data exchange process. Not all  
739 inputs are mandatory for every data exchange.

740  
741

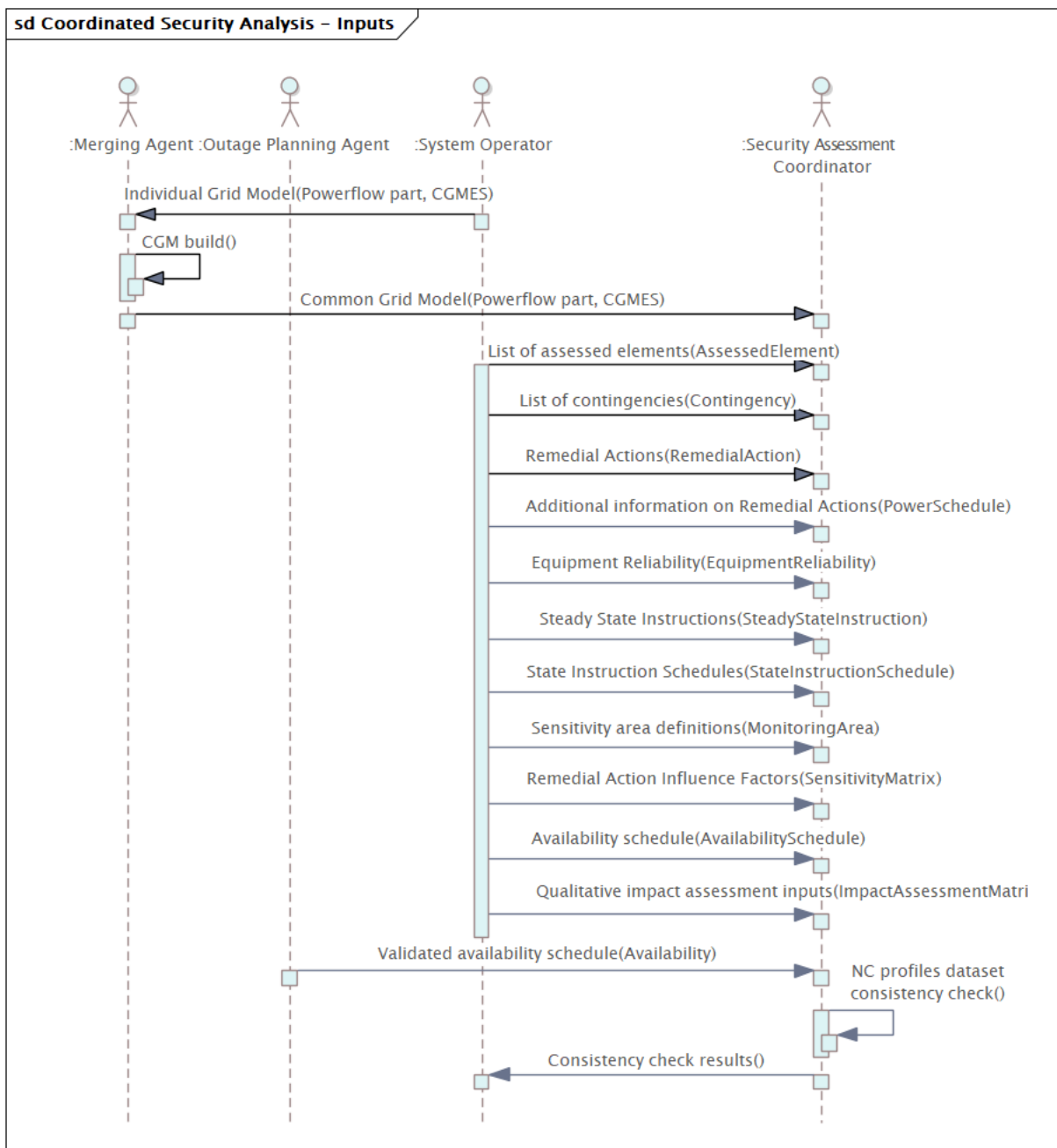

742  
743 **Figure 5 – CSA inputs Sequence diagram**

744 The process starts with the submission of the IGM from each SO to the Merging Agent. Each  
745 IGM is composed by at least four datasets conforming to profiles providing data for power flow  
746 calculation and its result (e.g. Equipment, Topology, Steady State Hypothesis and State  
747 Variables). The frequency of submission of these profiles is different. In the case of equipment  
748



749 and topology and their boundaries have to be submitted when there are equipment or topology  
750 changes. For steady state hypothesis and state variables, they will have to be submitted per  
751 market time unit (e.g. 1 hour or 15 min resolution). Merging Agent merges all the IGMs and  
752 provides the CGM to the Security Assessment Coordinator.  
753 In addition, the SO provides all relevant data needed for the business process, e.g. the list of  
754 assessed elements, contingencies, remedial actions, power schedule, equipment reliability,  
755 steady state instructions, schedules, sensitivity area definitions, remedial action influence  
756 factors and availability schedules. Outage planning agent provides the validated availability  
757 schedules which is an output of the OPC process.  
758 Validation of consistency between “All relevant data” and CGM is performed as part of the  
759 business process, and it is not in scope for the CGM Build process. For details, refer to section  
760 8.1.  
761

762 Figure 6 shows a sequence diagram of the CSA data exchange process. Note that not all data  
 763 exchanges shown are mandatory for each variation of the business process.  
 764  
 765

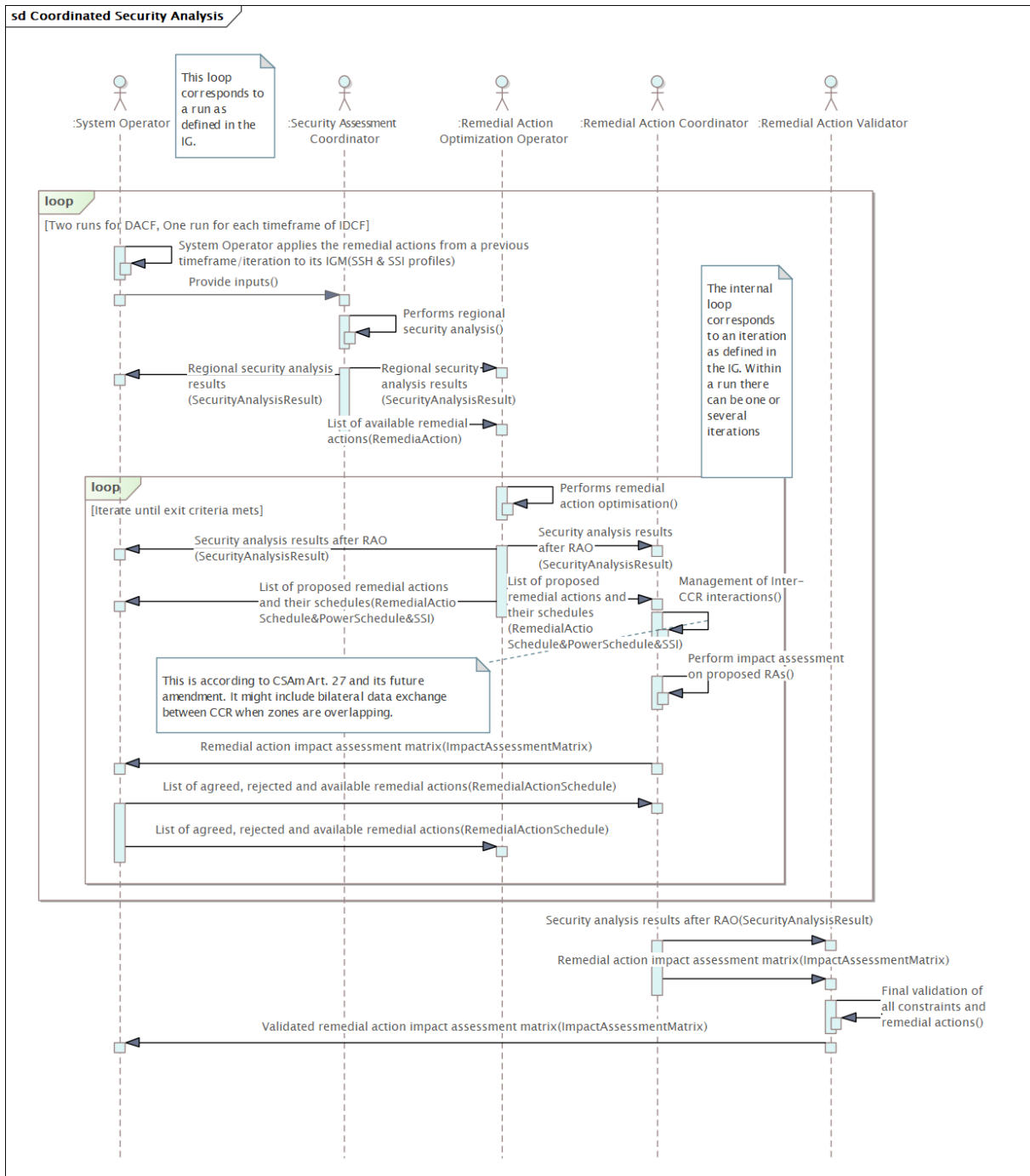

766  
 767  
 768  
 769  
 770  
 771  
 772  
 773

**Figure 6 - CSA general sequence diagram**

With all the inputs, Security Assessment Coordinator runs the regional security analysis. Basically, the security assessment allows to identify potential congestions in the grid. The result of this contingency analysis contains the identified limit violations in both base case (N situation) and considering contingencies (N-1, N-x situation). Apart from the violations, Security Assessment Coordinator also provides the remedial actions to the Remedial Action

774 Optimization Operator. These remedial actions are part of the structural data and designed  
775 to solve identified constraints.  
776 The remedial action optimization is performed for each Capacity Calculation Region. As a  
777 result of the optimisation, the security analysis after RAO and a list of proposed remedial  
778 actions together with their schedules are delivered to both System Operator and Remedial  
779 Action Coordinator.  
780 After that, Remedial Action Coordinator addresses the cross-CCR interactions which  
781 consists in addressing the cross-impacts between CCRs on the overlapping zones. Just  
782 after the CCR interactions, remedial action coordinator performs the impact assessment on  
783 the proposed remedial actions. The outcome of this process is the impact assessment  
784 matrix<sup>5</sup>. The main purpose of the matrix is to identify the affected SOs for each remedial  
785 action. The impact assessment matrix is delivered to the SOs. It can also serve as input  
786 provided by an SO in case of qualitative assessment process. Each SO shall agree or reject  
787 each remedial action by which it is impacted. If a SO rejects a remedial action, it shall  
788 provide the reasoning and (optionally) suggest alternative new available remedial actions  
789 or modified available remedial actions. Both optimization and coordination are repeated  
790 during several iterations until exit criteria is met. The exit criteria can be, for instance, when  
791 all the identified constraints have been solved with the agreed remedial actions, or time limit  
792 is reached.  
793 The big loop is also defined as run. In Day-Ahead there will be two coordination runs and  
794 in Intraday only one. Basically, for the day ahead, the process is repeated twice.  
795 After coordination, a final remedial action validation session is performed by the remedial  
796 action validator which receives from remedial action optimization operator the security  
797 analysis results and the impact assessment matrix. The main activity during the Final  
798 Validation Session is to review unresolved relevant identified constraints (on assessed  
799 elements) and discuss or find possible follow-up activities by SOs and Remedial Action  
800 Validator. Finally, the validated impact assessment matrix is delivered to the System  
801 Operator and the process finishes.

---

<sup>5</sup> As part of the quantitative assessment. The qualitative assessment already took place before.

802 **7 CSA Subprocesses**

803 The CSA subprocesses are detailed in the following sections.

804 **7.1 Input Data Preparation**

805 **7.1.1 Description**

806 In this step the System Operator prepares and provides the input data to be used in the business  
807 process (e.g. CSA). An overview of the subprocess is illustrated in Figure 7.

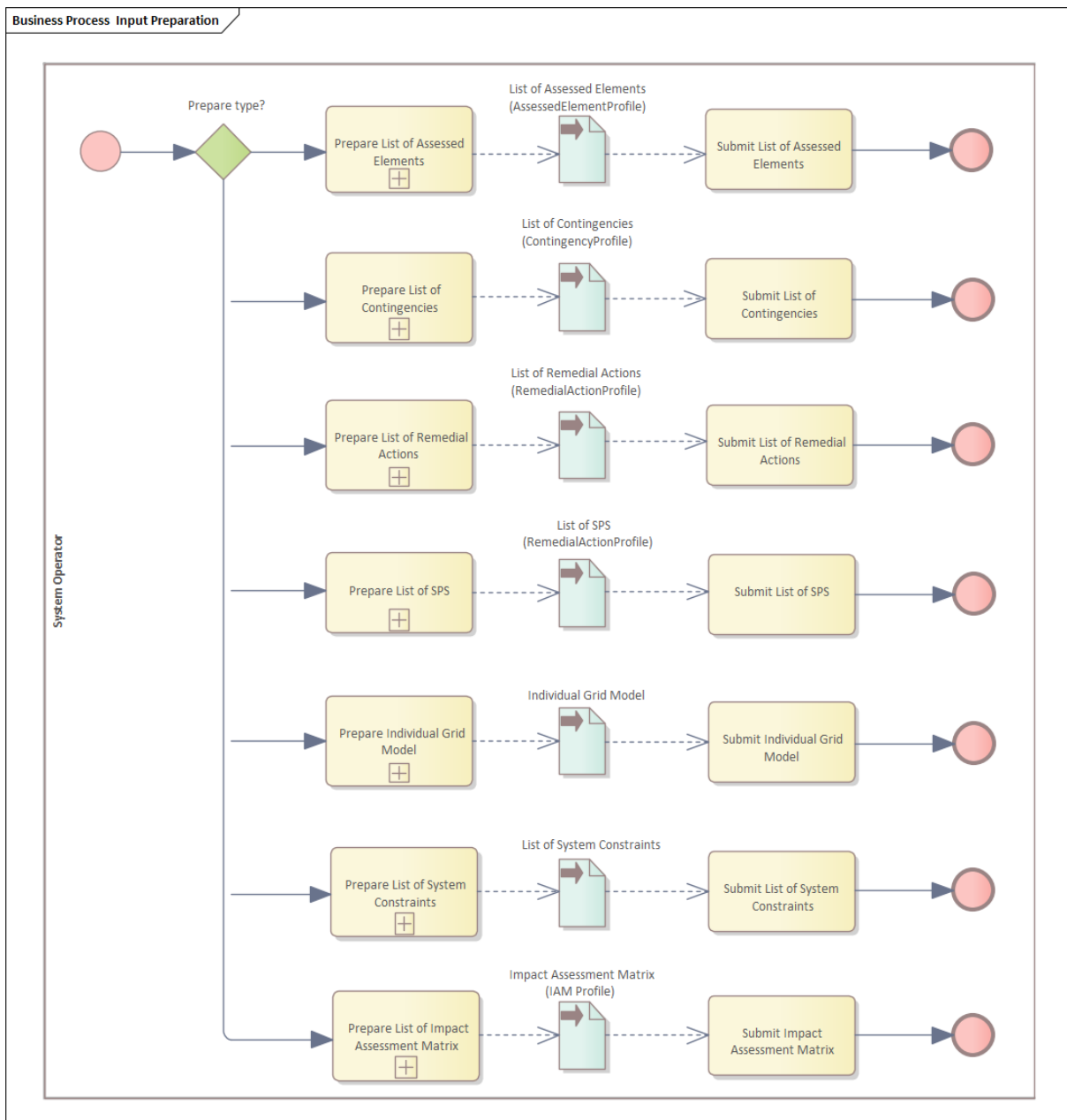

808

809 **Figure 7 – Input Data Preparation**

810

810 **7.1.2 Inputs and Outputs**

811 The list of Inputs and Outputs that are part of the subprocess is defined in Table 4.

812

813

**Table 4 – Inputs and Outputs for Input Data Preparation**

Inputs	Outputs
	Individual Grid Model (for the studied timeframe)
	List of Assessed Elements
	List of Contingencies
	List of Remedial Actions
	List of SPS (optional)
	List of System Constraints
	Impact assessment matrix

814

815 As the Input Data Preparation is considered the start of the business process, the datasets  
816 prepared by the TSOs are considered as outputs of this step.

817

818 The inputs listed in Table 4 can be provided using different data exchange profiles, according  
819 to the process and/or timeframe. The profile dependency and profile hierarchy are explained in  
820 § 8.2.

### 821 7.1.3 Input Data Design

822 The NC profiles are designed to support various use cases and profile flexibility on how the  
823 data is defined. There are three main categories of data:

- 824 • Structural data: data that is exchanged to define the configuration, the structure, of a  
825 given set of information. This data is exchanged only if the configuration is changed.

- 826 • Scheduled data: data that includes information for multiple time stamps in a form of a  
827 schedule.

- 828 • Data per time unit (MTU): data that is updated and exchanged for each market time unit,  
829 which can be hourly or less.

830 Each instance of data is uniquely identified by its identifier. The identifier shall be kept persistent  
831 to enable optimal data exchange that relies on the principle to exchange only the necessary  
832 data and do not duplicate. Besides the objective to achieve optimal volume of data exchange,  
833 it is required to track and report on different outcomes of the business processes, and this can  
834 only be achieved if the identifiers are persistent. For instance, to report on the agreement  
835 process on a remedial action schedule the identifiers of the RemedialAction,  
836 RemedialActionSchedule and the RemedialActionScheduleAcceptance have to be persistent.

837 By design the NC profiles implement a clear hierarchy between the profiles that govern  
838 structural data, scheduled data and data per time unit. For the scope of application of scheduled  
839 data and data per time unit, some data (normally has normal values) provided as part of  
840 structural data could be updated. The possibility to exchange these values as a schedule is  
841 provided by State Instruction Schedule profile (SIS). The possibility to update the values on per  
842 time unit basis is provided by Steady State Instruction profile (SSI). There are a couple of  
843 options that can be applied when designing the setup of the input data.

- 844 • Option 1: Rely on information in structural data.

845 This option is applied when the System Operator assesses that some type of data will  
846 not be changed so often and there is no need to provide schedule or per time unit  
847 exchange. In this case there is no need to use SIS and SSI profiles for this type of data.

- 848 • Option 2: Provide default (normal) values in the structural data and supply scheduled  
849 information.

850 This option is used when the System Operator assesses that there is a need to update  
851 or complement the data by using a schedule, i.e. profile the status information for the

852 next 24 hours. The provision of normal values in structural data is optional. Any data for  
853 which a schedule exists will override normal values in structural data for this schedule  
854 calculation.

- 855 • Option 3: Provide default (normal) values in the structural data and supply data on per  
856 time unit basis

857 This option is used when the System Operator assesses that there is a need to update  
858 the information per each market time unit. Any data for which per time unit data is  
859 provided exists will override both normal values provided by structural data and  
860 scheduled data, if defined – for this very MTU. The provision of normal values in  
861 structural data is not required for all properties.

- 862 • Option 4: Combine different approaches

863 This approach combines different options in order to achieve an optimal data exchange  
864 by providing only the information essential for the business process.

- 865 • Option 5: Scheduled data provided after per time unit data

866 This option is used when the System Operator provides scheduled data after submission  
867 of per time unit data. This option requires to also consider the sequence of data  
868 submission and give priority to SIS data over the SSI data, which overrides the main  
869 principle that SSI data is expected to be more exact. Therefore this option is not  
870 recommended and if business processes would like to use it will need to define  
871 additional rules.

872 The receiving systems shall be designed to handle different options taking into account the  
873 priority of the profiles. It should be noted that the options may not be applied in a consistent  
874 way for the complete dataset and it is allowed to be mixed depending on the nature of the input  
875 data. Table 5 illustrates the approach for the enabling of an AssessedElement.

876 **Table 5 – Illustration of input data combinations for enabling of an AssessedElement**

Structural data	Scheduled data (SIS)	Per MTU data (SSI)	Result
Provided	Not provided	Not provided	AssessedElement.normalEnabled from structural data applies
Provided	Provided	Not provided	AssessedElementTimePoint.enabled from SIS applies
Provided	Provided	Provided	AssessedElement.enabled from SSI applies
Provided for AE 1, Provided for AE 2 Not provided for AE 3 <sup>6</sup>	Provided for AE 1, Not provided for AE 2 Not provided for AE 3	Not provided for AE 1 Not provided for AE 2 Provided for AE 3	AssessedElementTimePoint.enabled from SIS applies for AE 1 AssessedElement.normalEnabled from structural data applies for AE 2 AssessedElement.enabled from SSI applies for AE 3  The rule is: For a given property (value), use SSI if available, otherwise SIS if available, otherwise normal value in structural data.
Provided	Provided but after SSI	Provided	AssessedElementTimePoint.enabled from SIS applies because the data is submitted after the SSI data. This option requires tracing of the submission time.

877  
878 There could be multiple datasets of the same type for the purpose to separate the usage. For  
879 instance, some regions can use metadata to enable the use case of providing a set of

<sup>6</sup> Structural data can optionally exchange normalEnabled (by profile definition), but the value in the normalEnabled is not provided (because optional).

880 AssessedElement objects for one part of the power system and another set of AssessedElement  
881 objects for another part of the power system. This will require that the receiving party  
882 understands the metadata provided in the manifest and/or in the dataset header if the party is  
883 interested in studying only one part of the power system or performing separate studies.

#### 884 7.1.4 Conformity Requirements

885 To be able to support input data preparation the Application shall conform to the following  
886 Application functions:

- 887 • Import of single dataset
- 888 • Export of single dataset
- 889 • Structural data setup
- 890 • Scheduled data setup.

#### 891 7.1.5 List of Assessed Elements

892 The List of Assessed Elements provision is illustrated in Figure 8.

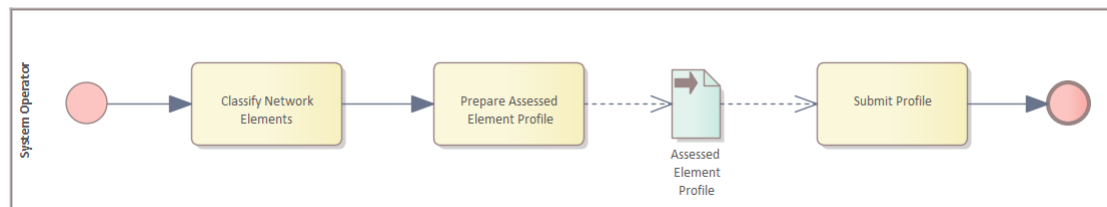

893

894 **Figure 8 –List of Assessed Elements provision**

895

896 The first step is to classify the Network Elements in the grid, the network element category  
897 diagram is represented in Figure 9.

898

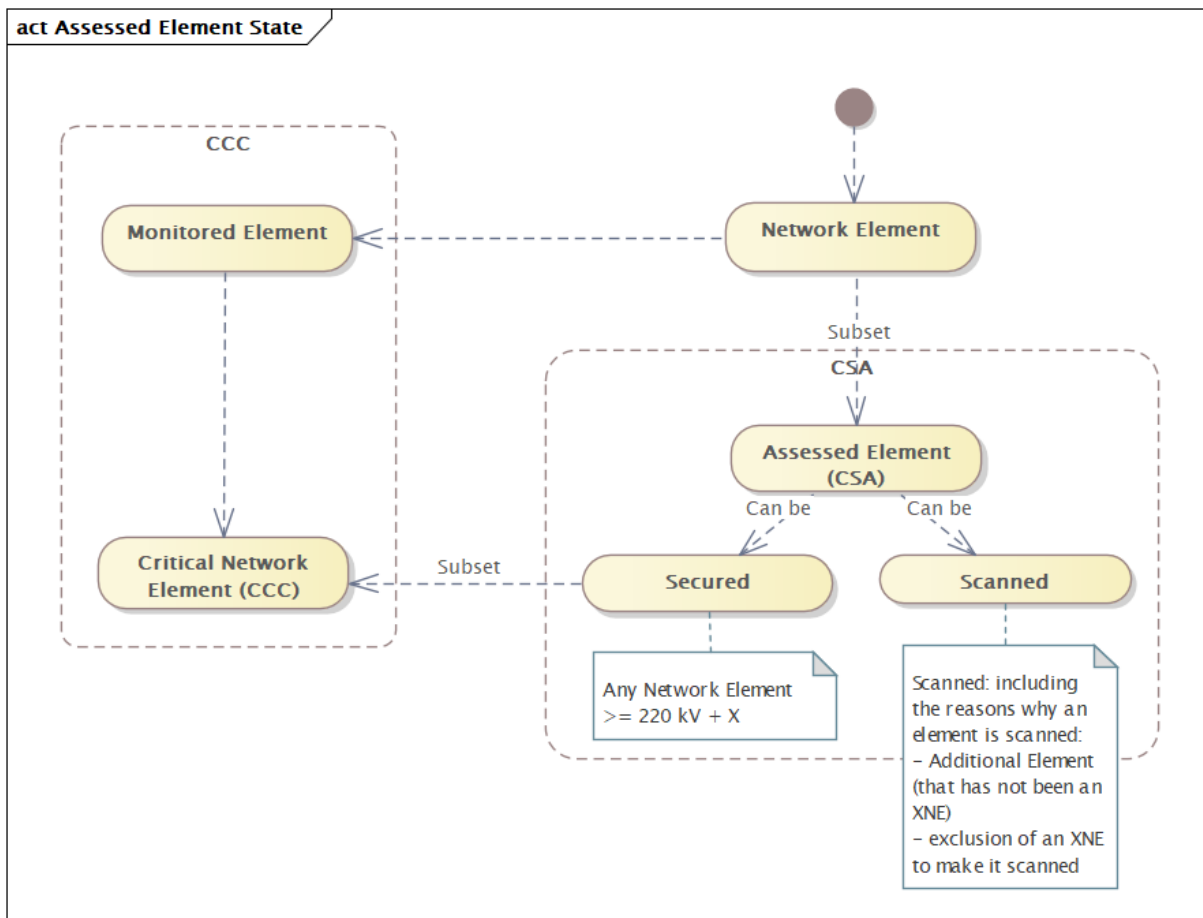

Figure 9 – Network element category diagram

899  
900  
901

902 Any network element can be an assessed element in a business process. The decision of which  
903 network elements are referred as assessed elements lies with the entity preparing the structural  
904 data, e.g. a TSO preparing assessed elements according to the requirements of business  
905 processes that perform the assessment. The assessed elements can be secured or scanned.  
906 A Secured element is an Assessed Element on which remedial actions are needed to relief  
907 violations of an operational security limit identified during the regional or cross-regional security  
908 analysis. For instance, a secured element would be a cross-border relevant network element  
909 (XNE), which includes all grid elements with a voltage level higher than or equal to 220 kV that  
910 are not intentionally excluded.

911 A scanned element is an Assessed Element on which the electrical state (at least flows) shall  
912 be computed and shall be subject to an observation rule during the regional security analysis  
913 process. Such observation rule can be for example avoiding the increase of a constraint or  
914 avoiding the creation of a constraint on this element, as a result of the design of remedial  
915 actions needed to relieve violations on the secured elements. A scanned element could be any  
916 grid element (if the grid element is not a CNE).

917 A critical network element is a network element monitored during the coordinated capacity  
918 calculation process. Critical network elements are a subset of the secured elements.

919 The second step is to provide the list of Assessed Elements using the Assessed Element profile.  
920 If an Assessed Element defined in the Assessed Element profile refers to an equipment or its  
921 controls that cannot be exchanged using CGMES Equipment profile used in the business  
922 process, there is a need to define it in the Equipment Reliability profile in case that profile  
923 supports the definition of the new equipment and/or its controls. For instance, Equipment



924 Reliability profile defines additional equipment and controls on HVDC, limits, reactive capability  
925 curves. Figure 46 illustrates the profiles dependencies. The System Operator shall ensure that  
926 the Assessed Elements are consistent with the power system model (IGM) valid for the validity  
927 period of the Assessed Element data.

928 The following general aspects apply when modelling assessed elements:

- 929 • The grid equipment that is assessed is in the Equipment profile dataset and is referenced  
930 by its mRID;
- 931 • The Region and SystemOperator in which/by which the AssessedElement is assessed are  
932 referenced by their mRIDs defined in the common data dataset (see Section 8.4) which  
933 conforms to the Equipment Reliability profile.
- 934 • When the reference to ConductingEquipment (e.g. a line, a transformer) is defined and there  
935 is no reference to OperationalLimit, the assessment is performed for all limits defined at all  
936 ends of the equipment. In case an AssessedElement object refers to a  
937 ConductingEquipment that has no limits defined in the underlying model the assessment  
938 will not be performed. Therefore, this needs to be detected in the consistency checks  
939 constraints. The advantage of using reference to OperationalLimit is that the target point of  
940 the assessment is defined in an exact way because the OperationalLimit relates to a type  
941 (e.g., PATL, TATL, etc.) and location (e.g., terminal at side 1 of the equipment).

942

#### 943 7.1.5.1 Secured Assessed Element

944 This example illustrates how to specify a Secured Assessed Element. Note that the example  
945 does not reflect universal way of modelling a secured assessed element and may miss regional  
946 specificities.

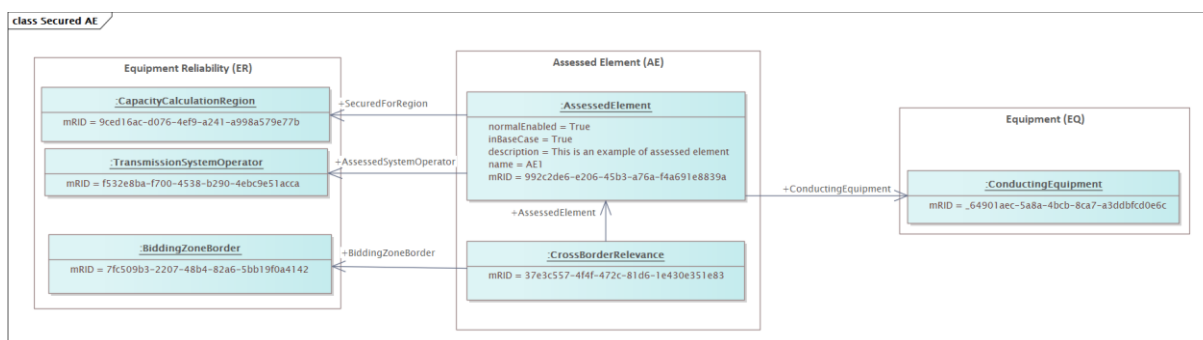

947

948 **Figure 10 – Secured Assessed Element example.**

949 The corresponding Assessed Element dataset snippet is as follows:

```

950 <nc:AssessedElement rdf:ID="_992c2de6-e206-45b3-a76a-f4a691e8839a">
951 <cim:IdentifiedObject.name>AE1</cim:IdentifiedObject.name>
952 <cim:IdentifiedObject.description>This is an example of assessed element.</cim:IdentifiedObject.description>
953 <cim:IdentifiedObject.mRID>992c2de6-e206-45b3-a76a-f4a691e8839a</cim:IdentifiedObject.mRID>
954 <nc:AssessedElement.ConductingEquipment rdf:resource="#_64901aec-5a8a-4bcb-8ca7-a3ddbfc0e6c"/>
955 <nc:AssessedElement.OperationalLimit rdf:resource="#_c50c3855-28e9-b2c8-5d9d-199a5dbff8f3"/>
956 <nc:AssessedElement.SecuredForRegion rdf:resource="#_9ced16ac-d076-4ef9-a241-a998a579e77b"/>
957 <nc:AssessedElement.AssessedSystemOperator rdf:resource="#_f532e8ba-f700-4538-b290-4ebc9e51acca"/>
958 <nc:AssessedElement.inBaseCase>true</nc:AssessedElement.inBaseCase>
959 <nc:AssessedElement.normalEnabled>true</nc:AssessedElement.normalEnabled>
960 </nc:AssessedElement>
961
962 <nc:CrossBorderRelevance rdf:ID="_37e3c557-4f4f-472c-81d6-1e430e351e83">
963 <nc:CrossBorderRelevance.mRID>37e3c557-4f4f-472c-81d6-1e430e351e83</nc:CrossBorderRelevance.mRID>
964 <nc:CrossBorderRelevance.AssessedElement rdf:resource="#_992c2de6-e206-45b3-a76a-f4a691e8839a"/>
965 <nc:CrossBorderRelevance.BiddingZoneBorder rdf:resource="#_7fc509b3-2207-48b4-82a6-5bb190a4142"/>
966 </nc:CrossBorderRelevance>
967

```

968 The following remarks apply to this example:

- 969 • In order to indicate that the assessed element should be assessed in the base case the  
970 attribute AssessedElement.inBaseCase is set to true.

### 971 7.1.5.2 Scanned Assessed Element

972 This example illustrates how to specify a Scanned Assessed Element which is secured in  
973 another Region. Note that the example does not reflect universal way of modelling a scanned  
974 assessed element and may miss regional specificities. Additionally, the example only covers  
975 how to model the scanned element in one region, however a model of secured element would  
976 exist in parallel and would be referencing another region without scanned status set. In other  
977 words, in case of modelling an assessed element which is considered scanned in one region  
978 (“excluded XNE with status scanned”) and at the same moment secured in another region  
979 (“XNE”), one has to model two objects with different attributes set (ScannedForRegion,  
980 SecuredForRegion and ExclusionReason) but referencing same equipment ID in the grid model.

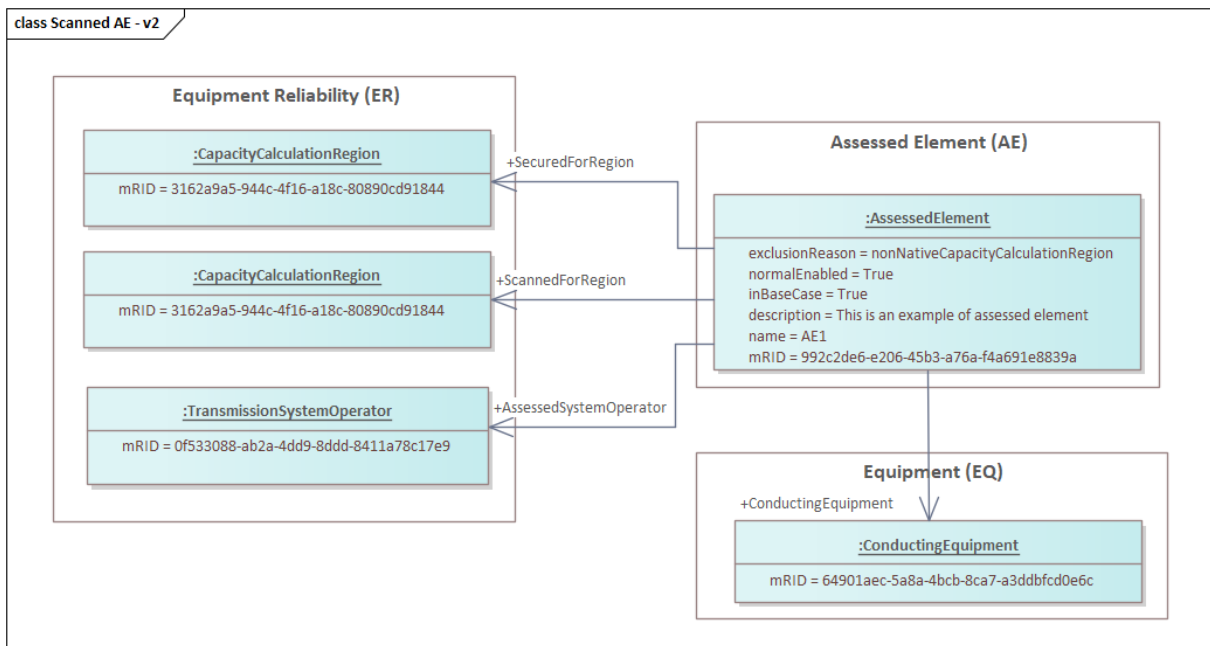

981

982 **Figure 11 – Scanned Assessed Element example**

983 The corresponding Scanned Element snippet in the Assessed Element dataset is as follows:

```
984 <nc:AssessedElement rdf:ID="_992c2de6-e206-45b3-a76a-f4a691e8839a">
985 <cim:IdentifiedObject.name>AE1</cim:IdentifiedObject.name>
986 <cim:IdentifiedObject.description>This is an example of assessed element.</cim:IdentifiedObject.description>
987 <cim:IdentifiedObject.mRID>992c2de6-e206-45b3-a76a-f4a691e8839a</cim:IdentifiedObject.mRID>
988 <nc:AssessedElement.ConductingEquipment rdf:resource="#_64901aec-5a8a-4bcb-8ca7-a3ddbfc0e6c"/>
989 <nc:AssessedElement.OperationalLimit rdf:resource="#_c50c3855-28e9-b2c8-5d9d-199a5dbff8f3"/>
990 <nc:AssessedElement.SecuredForRegion rdf:resource="#_3162a9a5-944c-4f16-a18c-80890cd91844"/>
991 <nc:AssessedElement.ScannedForRegion rdf:resource="#_3162a9a5-944c-4f16-a18c-80890cd91844"/>
992 <nc:AssessedElement.AssessedSystemOperator rdf:resource="#_0f533088-ab2a-4dd9-8ddd-8411a78c17e9"/>
993 <nc:AssessedElement.exclusionReason rdf:resource="
994 https://cim4.eu/ns/nc#SecuredExclusionReasonKind.nonNativeCapacityCalculationRegion"/>
995 <nc:AssessedElement.inBaseCase>true</nc:AssessedElement.inBaseCase>
996 </nc:AssessedElement>
```

997 The following remarks apply to this example:

- 998 • In this case the AssessedElement is not assessed in the base case, the attribute  
999 AssessedElement.inBaseCase should be set to false.
- 1000 • Depending on the meaning, if it is meant to be applicable for a secured region (and not for  
1001 scanned region), the exclusionReason needs to be added.

1002

1003 **7.1.5.3 Disable an Assessed Element**

1004 An AssessedElement object can be disabled in the structural data and in the scheduled or data  
 1005 per time unit. In case the disabling of the object is done on either scheduled data or per time  
 1006 unit data, this disabling is referred as “Temporary” disabled object. This example is derived  
 1007 from 7.1.5.1 to show how to disable for a specific time in the process an Assessed Element  
 1008 defined in the structural data. This is done by submission of a State Instruction Schedule (SIS)  
 1009 dataset or by submission of a Steady State Instruction (SSI) dataset (details regarding the  
 1010 profiles hierarchy can be found in § 8.2). Guidance on the design is provided in section 7.1.3.  
 1011 In addition, normally in case it is necessary to exclude a secured AssessedElement object a  
 1012 reason for this exclusion needs to be provided.

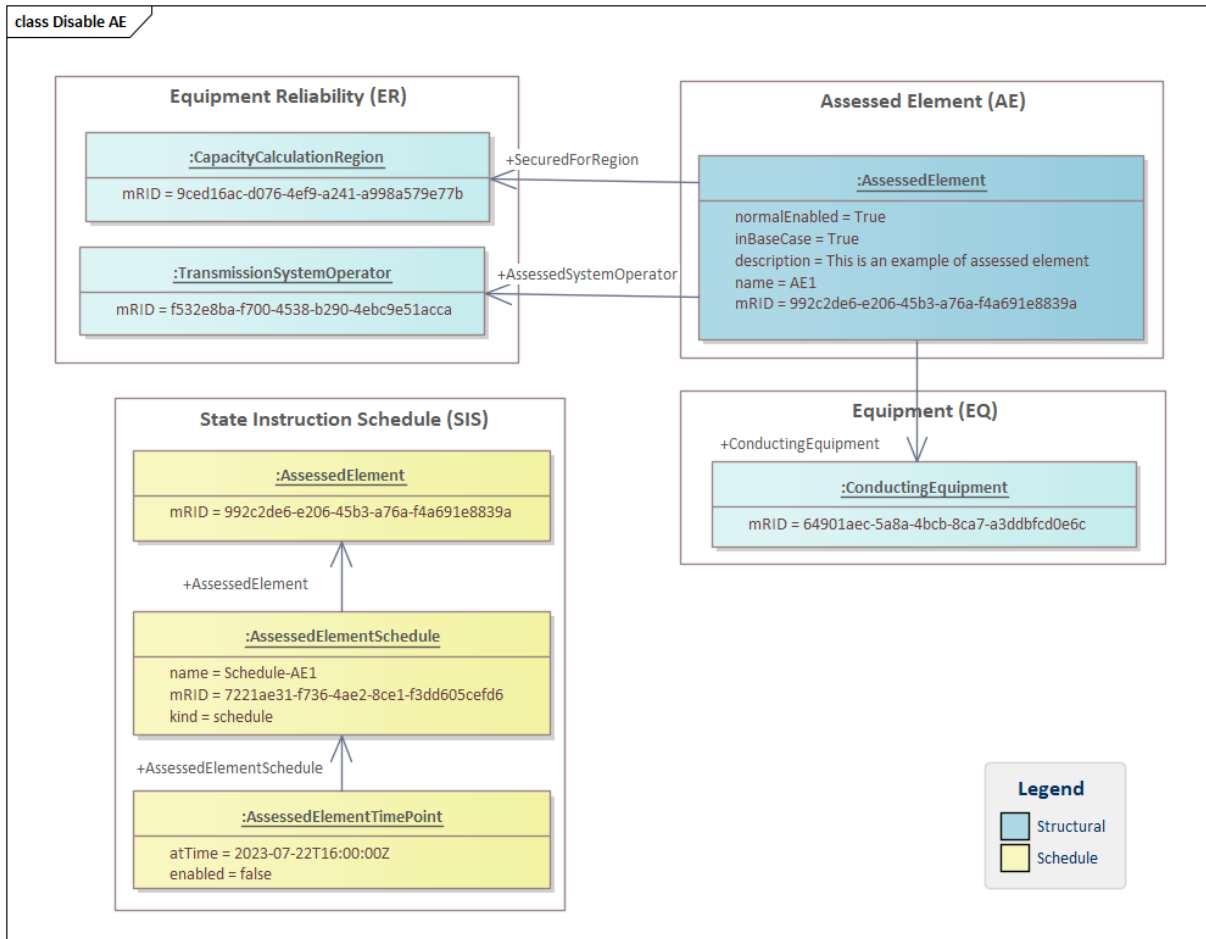

1013

1014

1015 **Figure 12 – Example Disable Assessed Element via SIS dataset**

1016 The Assessed Element dataset is the same as in 7.1.5.1. The SIS dataset which disables the  
 1017 assessed element from Figure 9 is as follows:

```

1018 <nc:AssessedElementSchedule rdf:ID="_7221ae31-f736-4ae2-8ce1-f3dd605cefd6">
1019   <cim:IdentifiedObject.name>AES1</cim:IdentifiedObject.name>
1020   <cim:IdentifiedObject.description>This is an example of assessed element
1021   schedule.</cim:IdentifiedObject.description>
1022   <cim:IdentifiedObject.mRID>7221ae31-f736-4ae2-8ce1-f3dd605cefd6</cim:IdentifiedObject.mRID>
1023   <nc:AssessedElementSchedule.AssessedElement rdf:resource="#_992c2de6-e206-45b3-a76a-f4a691e8839a"/>
1024   <nc:BaseTimeSeries.interpolationKind rdf:resource="https://cim4.eu/ns/nc#TimeSeriesInterpolationKind.none"/>
1025 </nc:AssessedElementSchedule>
1026
1027 <nc:AssessedElementTimePoint rdf:ID="_a26e3ae0-0a7d-4f42-ad64-e9105ec3cd41">
1028   <nc:AssessedElementTimePoint.AssessedElementSchedule rdf:resource="#_7221ae31-f736-4ae2-8ce1-f3dd605cefd6"/>
1029   <nc:AssessedElementTimePoint.atTime>2023-06-15T22:30:00Z</nc:AssessedElementTimePoint.atTime>
1030   <nc:AssessedElementTimePoint.enabled>false</nc:AssessedElementTimePoint.enabled>
    
```

1031 </nc:AssessedElementTimePoint>

1032 **7.1.5.4 Exclude an Assessed Element**

1033 This example shows how to exclude in the process an Assessed Element defined in the  
1034 structural data. Exclusion allows regional security analysis calculation, but it is not considered  
1035 in RAO as an element which would be optimized (secured). Excluded elements can be treated  
1036 as scanned elements (by setting the scanned status via ScannedForRegion reference) or simply  
1037 be ignored by RAO. .

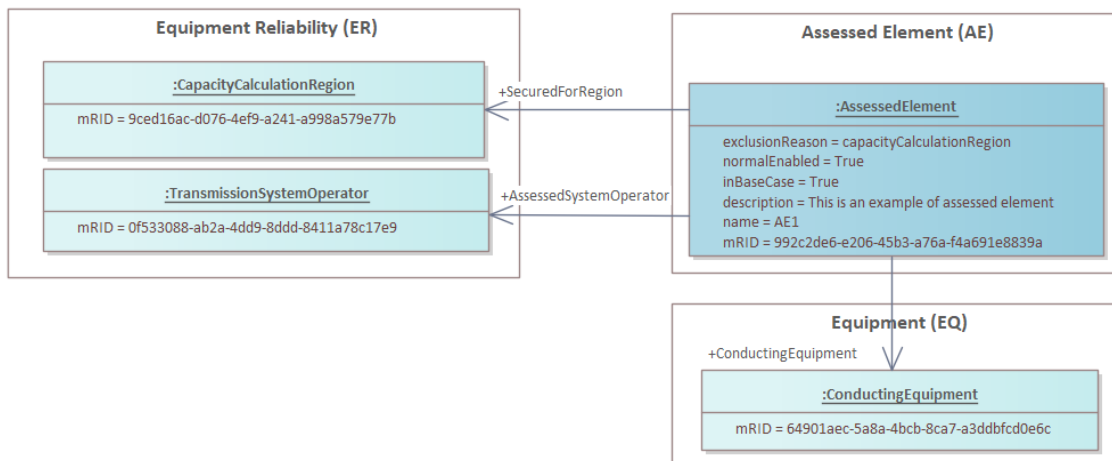

1038

1039 **Figure 13 – Exclude Assessed Element example.**

1039

1040 The Assessed Element dataset snippet is as follows:

```

1041 <nc:AssessedElement rdf:ID="_992c2de6-e206-45b3-a76a-f4a691e8839a">
1042 <cim:IdentifiedObject.name>AE1</cim:IdentifiedObject.name>
1043 <cim:IdentifiedObject.description>This is an example of assessed element.</cim:IdentifiedObject.description>
1044 <cim:IdentifiedObject.mRID>992c2de6-e206-45b3-a76a-f4a691e8839a</cim:IdentifiedObject.mRID>
1045 <nc:AssessedElement.ConductingEquipment rdf:resource="#_64901aec-5a8a-4bcb-8ca7-a3ddbfc0e6c"/>
1046 <nc:AssessedElement.OperationalLimit rdf:resource="#_c50c3855-28e9-b2c8-5d9d-199a5dbff8f3"/>
1047 <nc:AssessedElement.SecuredForRegion rdf:resource="#_9ced16ac-d076-4ef9-a241-a998a579e77b"/>
1048 <nc:AssessedElement.exclusionReason rdf:resource="https://cim4.eu/ns/nc#capacityCalculationRegion"/>
1049 <nc:AssessedElement.AssessedSystemOperator rdf:resource="#_0f533088-ab2a-4dd9-8ddd-8411a78c17e9"/>
1050 <nc:AssessedElement.inBaseCase>true</nc:AssessedElement.inBaseCase>
1051 </nc:AssessedElement>
    
```

1052

1053 **7.1.5.5 Assessed Element with Contingency**

1054 This section presents examples to illustrate how to cover different use cases that require  
1055 specification of an Assessed Element (AE) with a Contingency (CO). The following uses cases  
1056 are covered:

- 1057 1) **Full scope:** An AE is considered for all contingencies.
- 1058 2) **Limited exclusion:** An AE is considered for all but few contingencies. For instance, an  
1059 "AE1" is excluded, i.e., not considered, when "CO1" or "CO2" are performed.
- 1060 3) **Limited inclusion:** An AE is considered only for limited number of contingencies. For  
1061 instance, an "AE1" for the equipment "Line1" (considering the operational limit  
1062 "CurrentLimit1") is checked only after the "CO1" and after the "CO2". In addition, any  
1063 remedial action can be used to solve the constraint except the ones that are associated  
1064 to a particular assessed element (see section 7.1.5.6).

1065 The following general remarks apply to the design of the included or excluded assessed  
1066 elements:

- 1067 • By providing a mechanisms of inclusion and exclusion, the data exchange specification  
1068 aims at enabling sending party to reflect on specific situations, to minimize the data  
1069 exchanged for the business process, to give guidance to the RAO which as a side effect  
1070 helps the performance of the business process.
- 1071 • The AE has an attribute `isCombinableWithContingency`. If this is set to True, RSA and  
1072 RAO would consider this AE available for combinations with all defined contingencies.  
1073 If this is the desired behaviour there is no need to define all pairs by using  
1074 `AssessedElementWithContingency`. If this is set to False, RSA and RAO would expect  
1075 to find instructions on concrete pairs (combinations) that are valid to be studied for this  
1076 AE.
- 1077 • The `AssessedElementWithContingency` provides information on the combination  
1078 between an `AssessedElement` and a Contingency. This combination can have the  
1079 meaning of “inclusion” or “exclusion”. If a combination is included RSA and RAO will  
1080 include it when performing the analysis. It does not make sense to define an included  
1081 combination for an `AssessedElement` that has the attribute  
1082 `isCombinableWithContingency` set to True as this will result in duplicated combinations.  
1083 The usage of “inclusion” has a meaning only when used for assessed elements that are  
1084 constrained, i.e., `isCombinableWithContingency` attribute is set to False. On the other  
1085 hand, the usage of “exclusion” of a combination only makes sense when  
1086 `isCombinableWithContingency` attribute is set to True, as RSA and RAO would implicitly  
1087 define all combinations between assessed elements and contingencies and will exclude  
1088 the combinations that are provided in the data exchange.
- 1089 • When defining an `AssessedElement` the System Operator can create multiple  
1090 `AssessedElements` objects that refer to same limit or equipment. This approach helps  
1091 in cases where it is required to combine the “inclusion” and the “exclusion” approach  
1092 which targets assessment of the same equipment. This is also required to address the  
1093 case in which TSO belongs to more than one CCR.
- 1094 • The data model used for the exchange provides means to enable or disable a  
1095 combination defined by `AssessedElementWithContingency` at structural data level. This  
1096 can be done at structural data level, the schedules or in the data exchange that is per  
1097 time unit. Therefore, RSA and RAO shall take into account all inputs when setting up  
1098 the combinations that would apply for a study of a timestamp. For example, an “AE1”  
1099 is defined in the structural data as combinable (`isCombinableWithContingency` set to  
1100 True). There are 2 `AssessedElementWithContingency` defined – “AE1-CO1” and “AE1-  
1101 CO2” that are both enabled in the structural data as “exclusion”. The SIS dataset  
1102 disables “AE1-CO1” and “AE1-CO2” for hour 1 and hour 2, but SSI dataset enables  
1103 “AE1-CO1” for hour 1. Therefore, when RAO prepares the study of hour 1, the “AE1”  
1104 will be assessed for all enabled contingencies for hour 1 except “CO1” as the “exclusion”  
1105 “AE1-CO1” is enabled in SSI dataset and the “exclusion” “AE1-CO2” remains disabled  
1106 by SIS dataset.
- 1107 In addition, the `AssessedElement` contain information on the kind of assessed element with  
1108 contingency often referred as network element with contingency. The enumeration  
1109 `NetworkElementContingencyKind` is used as follows:
- 1110 • validation – if the `AssessedElement` is not Critical Network Element and Contingency  
1111 (CNEC) and it is not Monitored Network Element and Contingency (MNEC)
- 1112 • monitored - if the `AssessedElement` is not CNEC and it is MNEC
- 1113 • critical - if the `AssessedElement` is CNEC and it is not MNEC
- 1114 • criticalAndMonitored - if the `AssessedElement` is CNEC and it is MNEC

1115 This together with the Individual Adjustment Value (IVA) and Common Adjustment Value (CVA)  
1116 are used for the intraday capacity calculation and it is provided to flow-based calculation  
1117 method. In the flow-based methodology IVA share is modified by TSOs during their security  
1118 analysis. This part of the business process is where those parameters should be defined in the  
1119 AE profile but might need SIS for updates. The current version of NC integration, IVA updates  
1120 are not included in the scope. This is why for now, only structured data for adjustment values  
1121 is needed. Updates are expected in next versions.

1122 A. Scenario 1 – Full scope: Modelling of AssessedElement implicitly combined with all  
1123 Contingencies

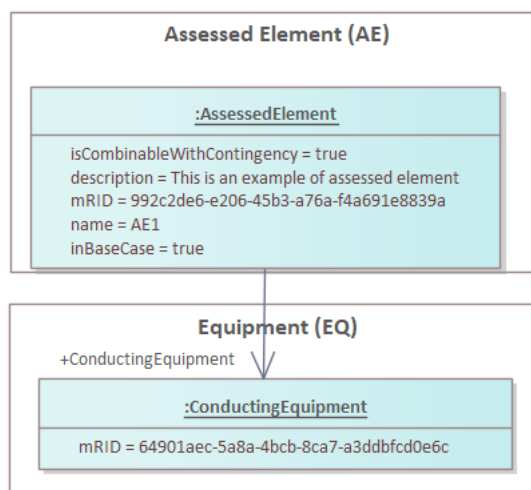

1124

1125 **Figure 14 – Assessed Element with Contingency – Scenario 1.**

1126

1127 The corresponding dataset snippet for scenario 1 is as follows:

```
1128 <nc:AssessedElement rdf:ID="_992c2de6-e206-45b3-a76a-f4a691e8839a">
1129   <cim:IdentifiedObject.name>AE1</cim:IdentifiedObject.name>
1130   <cim:IdentifiedObject.description>This is an example of assessed element.</cim:IdentifiedObject.description>
1131   <cim:IdentifiedObject.mRID>992c2de6-e206-45b3-a76a-f4a691e8839a</cim:IdentifiedObject.mRID>
1132   <nc:AssessedElement.ConductingEquipment rdf:resource="#_64901aec-5a8a-4bcb-8ca7-a3ddbfc0e6c"/>
1133   <nc:AssessedElement.inBaseCase>true</nc:AssessedElement.inBaseCase>
1134   <nc:AssessedElement.isCombinableWithContingency>true</nc:AssessedElement.isCombinableWithContingency>
1135 </nc:AssessedElement>
1136
```

1137 The following remarks apply to this example:

- 1138 • In this case the AssessedElement is assessed in the base case as the attribute  
1139 AssessedElement.inBaseCase is set to true.
- 1140 • The scenario covers the case where an AE is considered for all contingencies (Full scope).  
1141 The attribute AssessedElement.isCombinableWithContingency is set to true, which means  
1142 that RSA and RAO will assess this AssessedElement for all contingencies defined in the  
1143 structural data and enabled for the timestamp that is studied.

1144

1145 B. Scenario 2 – Limited exclusion: Modelling of AssessedElement with Contingency

1146 Scenario 2 occurs in cases where an assessed element is set as combinable with all  
1147 Contingency objects defined and enabled for the timestamp that is studied, but a combination  
1148 with particular Contingency is excluded from the study. The example focuses on  
1149 OrdinaryContingency but can be applied for any other type of contingencies supported by the  
1150 Contingency profile.

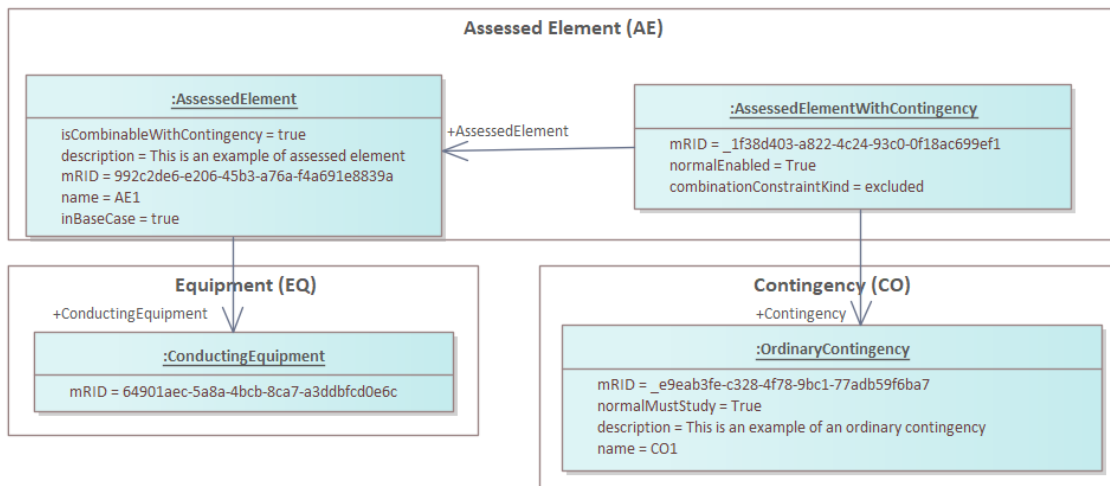

1151

1152

Figure 15 – Assessed Element with Contingency – scenario 2.

1153

The corresponding dataset snippet for scenario 2 is as follows:

1154

1155

1156

1157

1158

1159

1160

1161

1162

1163

1164

1165

1166

1167

1168

1169

1170

1171

```

<nc:AssessedElement rdf:ID="_992c2de6-e206-45b3-a76a-f4a691e8839a">
  <cim:IdentifiedObject.name>AE1</cim:IdentifiedObject.name>
  <cim:IdentifiedObject.description>This is an example of assessed element.</cim:IdentifiedObject.description>
  <cim:IdentifiedObject.mRID>992c2de6-e206-45b3-a76a-f4a691e8839a</cim:IdentifiedObject.mRID>
  <nc:AssessedElement.ConductingEquipment rdf:resource="#_64901aec-5a8a-4bcb-8ca7-a3ddbfc0e6c"/>
  <nc:AssessedElement.inBaseCase>true</nc:AssessedElement.inBaseCase>
  <nc:AssessedElement.isCombinableWithContingency>true</nc:AssessedElement.isCombinableWithContingency>
</nc:AssessedElement>

<nc:AssessedElementWithContingency rdf:ID="_1f38d403-a822-4c24-93c0-0f18ac699ef1">
  <nc:AssessedElementWithContingency.mRID>1f38d403-a822-4c24-93c0-0f18ac699ef1</nc:AssessedElementWithContingency.mRID>
  <nc:AssessedElementWithContingency.Contingency rdf:resource="#_e9eab3fe-c328-4f78-9bc1-77adb59f6ba7"/>
  <nc:AssessedElementWithContingency.AssessedElement rdf:resource="#_992c2de6-e206-45b3-a76a-f4a691e8839a"/>
  <nc:AssessedElementWithContingency.combinationConstraintKind
rdf:resource="https://cim4.eu/ns/nc#ElementCombinationConstraintKind.excluded"/>
  <nc:AssessedElementWithContingency.normalEnabled>true</nc:AssessedElementWithContingency.normalEnabled>
</nc:AssessedElementWithContingency>

```

1172

The following remarks apply to this example:

1173

1174

1175

- AssessedElementWithContingency object is defined to identify the pair (combination) that is excluded from the study, i.e. contingency analysis.

1176

The Contingency dataset snippet is as follows:

1177

1178

1179

1180

1181

1182

1183

```

<nc:OrdinaryContingency rdf:ID="_e9eab3fe-c328-4f78-9bc1-77adb59f6ba7">
  <cim:IdentifiedObject.name>CO1</cim:IdentifiedObject.name>
  <cim:IdentifiedObject.description>This is an example of an ordinary contingency;Tie Line
loss</cim:IdentifiedObject.description>
  <cim:IdentifiedObject.mRID>e9eab3fe-c328-4f78-9bc1-77adb59f6ba7</cim:IdentifiedObject.mRID>
  <nc:Contingency.normalMustStudy>true</nc:Contingency.normalMustStudy>
</nc:OrdinaryContingency>

```

1184

### C. Scenario 3 – Limited inclusion: Modelling of AssessedElement with Contingency

1185

1186

1187

1188

1189

Scenario 3 occurs in cases where an assessed element is defined as not combinable with all Contingency objects, defined and enabled for the timestamp that is studied, but a combination with particular Contingency is included in the study. The example is focused on OrdinaryContingency but can be applied for any other type of contingencies supported by the Contingency profile.

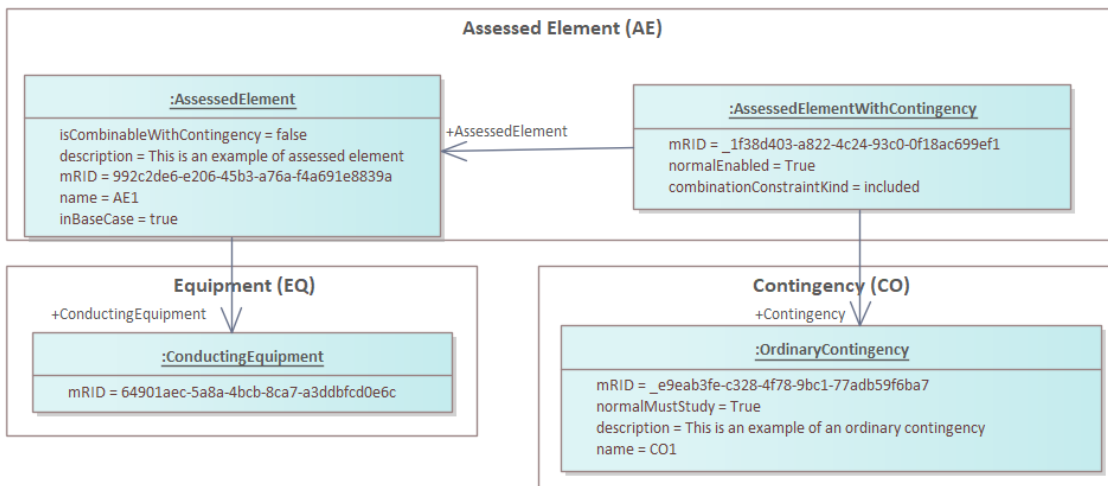

1190

1191 **Figure 16 – Assessed Element with Contingency – scenario 3.**

1192 The corresponding Assessed Element dataset snippet is as follows:

```

1193 <nc:AssessedElement rdf:ID="_992c2de6-e206-45b3-a76a-f4a691e8839a">
1194   <cim:IdentifiedObject.name>AE1</cim:IdentifiedObject.name>
1195   <cim:IdentifiedObject.description>This is an example of assessed element.</cim:IdentifiedObject.description>
1196   <cim:IdentifiedObject.mRID>992c2de6-e206-45b3-a76a-f4a691e8839a</cim:IdentifiedObject.mRID>
1197   <nc:AssessedElement.ConductingEquipment rdf:resource="#_64901aec-5a8a-4bcb-8ca7-a3ddbfc0e6c"/>
1198   <nc:AssessedElement.inBaseCase>true</nc:AssessedElement.inBaseCase>
1199   <nc:AssessedElement.isCombinableWithContingency >false</nc:AssessedElement.isCombinableWithContingency>
1200 </nc:AssessedElement>
1201
1202 <nc:AssessedElementWithContingency rdf:ID="_1f38d403-a822-4c24-93c0-0f18ac699ef1">
1203   <nc:AssessedElementWithContingency.mRID>1f38d403-a822-4c24-93c0-
1204   0f18ac699ef1</nc:AssessedElementWithContingency.mRID>
1205   <nc:AssessedElementWithContingency.Contingency rdf:resource="#_e9eab3fe-c328-4f78-9bc1-77adb59f6ba7"/>
1206   <nc:AssessedElementWithContingency.AssessedElement rdf:resource="#_992c2de6-e206-45b3-a76a-f4a691e8839a"/>
1207   <nc:AssessedElementWithContingency.combinationConstraintKind
1208   rdf:resource="https://cim4.eu/ns/nc#ElementCombinationConstraintKind.included"/>
1209   <nc:AssessedElementWithContingency.normalEnabled>true</nc:AssessedElementWithContingency.normalEnabled>
1210 </nc:AssessedElementWithContingency>
    
```

1211 The Contingency dataset snippet is as follows:

```

1212 <nc:OrdinaryContingency rdf:ID="_e9eab3fe-c328-4f78-9bc1-77adb59f6ba7">
1213   <cim:IdentifiedObject.name>CO1</cim:IdentifiedObject.name>
1214   <cim:IdentifiedObject.description>This is an example of an ordinary contingency; Tie Line
1215   loss</cim:IdentifiedObject.description>
1216   <cim:IdentifiedObject.mRID>e9eab3fe-c328-4f78-9bc1-77adb59f6ba7</cim:IdentifiedObject.mRID>
1217   <nc:Contingency.normalMustStudy>true</nc:Contingency.normalMustStudy>
1218 </nc:OrdinaryContingency>
    
```

1219 The following remarks apply to this example:

- 1220 • The AssessedElement and the Contingency that are linked are referenced in the
- 1221 AssessedElementWithContingency object by their mRIDs;
- 1222 • The contingency type can also be ExceptionalContingency and OutOfRangeContingency;
- 1223 • AssessedElement class has other mandatory attributes already presented in section 7.1.5.1
- 1224 and 7.1.5.2.

1225

1226 **7.1.5.6 Assessed Element with Remedial Action**

1227 This section presents examples to illustrate how to cover different use cases that require

1228 specification of an Assessed Element (AE) with a Remedial Action (RA). The following uses

1229 cases are covered:

- 1230 1) **Full scope:** All defined and enabled remedial actions are considered when resolving a
- 1231 violation of an assessed element.



1232 2) **Limited inclusion:** One or limited number of remedial actions are considered (the only  
1233 RA that are applicable) when resolving a violation of an assessed element.

1234 3) **Limited exclusion:** One or limited number of remedial actions are not considered when  
1235 resolving a violation of an assessed element. For instance, “RA1” is excluded, i.e., not  
1236 considered/not used as possible RA, when “AE1” or “AE2” are having violations.

1237 4) **Consideration:** One or limited number of remedial actions can be considered when  
1238 resolving a violation of an assessed element. The difference between limited inclusion  
1239 and consideration is that in consideration multiple remedial action can be considered,  
1240 while in the limited inclusion only defined remedial action are applicable.

1241 The following general remarks apply to the design of the included, excluded, or considered  
1242 remedial actions:

1243 • By providing a mechanisms of inclusion and exclusion, the data exchange specification  
1244 aims at enabling sending party to reflect on specific situations, to minimize the data  
1245 exchanged for the business process, to give guidance to the RAO which as a side effect  
1246 helps the performance of the business process. In general, all remedial actions can be  
1247 considered for all assessed elements, but this would take significant amount of time.

1248 • Constraining RAO by limiting the possibilities on which remedial actions can be used  
1249 for resolving violations on assessed elements can be considered a breach of the  
1250 requirements defined in Network Codes and methodologies. Therefore, it should only  
1251 be used in cases where this helps the performance of the process but does not limit the  
1252 effect of optimising remedial actions and finding the best possible solution.

1253 • The AE has an attribute isCombinableWithRemedialAction. If this is set to True, RAO  
1254 would consider this AE available for combinations will all defined remedial actions. if  
1255 this is the desired behaviour there is no need to define all pairs by using  
1256 AssessedElementWithRemedialAction. If this is set to False, RAO would expect to find  
1257 instructions on which concrete pairs (combinations) are valid to be studied for this AE.

1258 • The AssessedElementWithRemedialAction provides information on the combination  
1259 between an AssessedElement and a RemedialAction. This combination can have the  
1260 meaning of “inclusion”, “exclusion” or “consideration”. If a combination is included RAO  
1261 will include it when performing the analysis. It does not make sense to define an included  
1262 combination for an AssessedElement that has the attribute  
1263 isCombinableWithRemedialAction set to True as this will result in duplicated  
1264 combinations. The usage of “inclusion” has a meaning only when used for assessed  
1265 elements that are constrained, i.e., isCombinableWithRemedialAction attribute is set to  
1266 False. On the other hand, the usage of “exclusion” of a combination only makes sense  
1267 when isCombinableWithRemedialAction attribute is set to True, as RAO would implicitly  
1268 define all combinations between assessed elements and remedial actions and will  
1269 exclude the combinations that are provided in the data exchange.

1270 • When defining an AssessedElement the System Operator can create multiple  
1271 AssessedElements objects that refer to same limit or equipment. This approach helps  
1272 in cases where it is required to combine “inclusion”, “exclusion”, and “consideration”  
1273 approaches which targets assessment of same equipment.

1274 • The data model used for the exchange provides means to enable or disable a  
1275 combination defined by AssessedElementWithRemedialAction. This can be done at  
1276 structural data level, the schedules or in the data exchange that is per time unit.  
1277 Therefore, RAO shall take into account all inputs when setting up the combinations that  
1278 would apply for a study of a timestamp. For example, an “AE1” is defined in the structural  
1279 data as combinable (isCombinableWithRemedialAction set to True). There are 2  
1280 AssessedElementWithRemedialAction defined – “AE1-RA1” and “AE1-RA2” that are

1281 both enabled in the structural data as “exclusion”. The SIS dataset disables “AE1-RA1”  
 1282 and “AE1-RA2” for hour 1 and hour 2, but SSI dataset enables “AE1-RA1” for hour 1.  
 1283 Therefore, when RAO prepares the study of hour 1, a violation of “AE1” will be resolved  
 1284 by one of all enabled remedial actions for hour 1 except “RA1” as the “exclusion” “AE1-  
 1285 RA1” is enabled in SSI dataset and the “exclusion” “AE1-RA2” remains disabled by SIS  
 1286 dataset.

- 1287 • Depending on the design of the remedial actions and assessed elements some  
 1288 combinations between assessed element and remedial action can be defined as  
 1289 “included” and some as “considered”. This will provide information to RAO that first the  
 1290 remedial actions that are “included” need to be optimised and if they are not able to  
 1291 resolve the violation some of the “considered” remedial actions can be  
 1292 studied/optimised. This approach can potentially be used with the design to include  
 1293 multiple remedial actions in a group and describe the dependency between the  
 1294 remedials actions in this group. The level of complexity increases and the guidance is  
 1295 to use this only when it is necessary and represents the real behaviour of these remedial  
 1296 actions.

1297 This example shows how to specify an Assessed Element with a “Tap Position” Remedial  
 1298 Action.

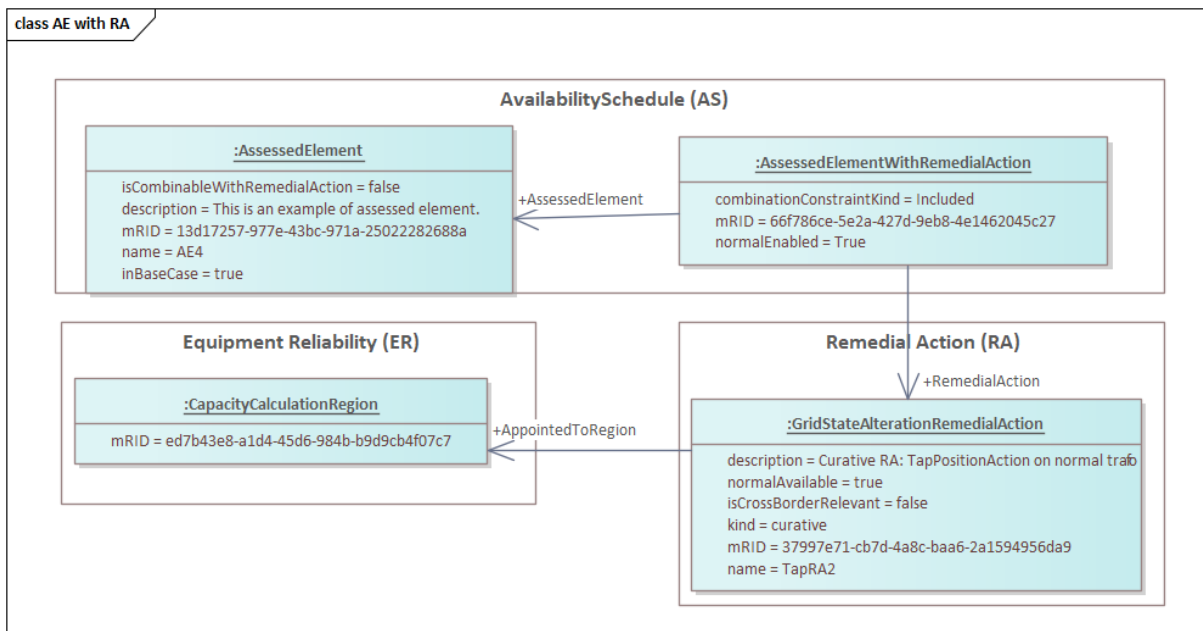

1299 **Figure 17 – Assessed Element with Remedial Action.**

1300 The corresponding Assessed Element dataset snippet is as follows:  
 1301

```

1302 <nc:AssessedElement rdf:ID="_13d17257-977e-43bc-971a-25022282688a">
1303   <cim:IdentifiedObject.name>AE4</cim:IdentifiedObject.name>
1304   <cim:IdentifiedObject.description>This is an example of assessed element.</cim:IdentifiedObject.description>
1305   <cim:IdentifiedObject.mRID>13d17257-977e-43bc-971a-25022282688a</cim:IdentifiedObject.mRID>
1306   <nc:AssessedElement.ConductingEquipment rdf:resource="#_550ebe0d-f2b2-48c1-991f-cebea43a21aa"/>
1307   <nc:AssessedElement.ScannedForRegion rdf:resource="#_5179eb50-d943-451c-af81-194bdf9505e5"/>
1308   <nc:AssessedElement.AssessedSystemOperator rdf:resource="#_517cc7b9-df0c-4065-a5f2-2b8d7d9c1457"/>
1309   <nc:AssessedElement.isCombinableWithRemedialAction>false</nc:AssessedElement.isCombinableWithRemedialAction>
1310   <nc:AssessedElement.inBaseCase>true</nc:AssessedElement.inBaseCase>
1311 </nc:AssessedElement>
1312 <nc:AssessedElementWithRemedialAction rdf:ID="_66f786ce-5e2a-427d-9eb8-4e1462045c27">
1313   <nc:AssessedElementWithRemedialAction.mRID>66f786ce-5e2a-427d-9eb8-
1314 4e1462045c27</nc:AssessedElementWithRemedialAction.mRID>
1315   <nc:AssessedElementWithRemedialAction.RemedialAction rdf:resource="#_37997e71-cb7d-4a8c-baa6-2a1594956da9"/>
1316   <nc:AssessedElementWithRemedialAction.AssessedElement rdf:resource="#_13d17257-977e-43bc-971a-25022282688a"/>
1317   <nc:AssessedElementWithRemedialAction.combinationConstraintKind
1318   rdf:resource="https://cim4.eu/ns/nc#ElementCombinationConstraintKind.included"/>
1319   <nc:AssessedElementWithRemedialAction.normalEnabled>true</nc:AssessedElementWithRemedialAction.normalEnabled>
1320 </nc:AssessedElementWithRemedialAction>
    
```

1321 The snippet in RemedialAction dataset for a tap position remedial action is as shown below.  
1322 Note that other remedial action types are possible.

```
1323 <nc:GridStateAlterationRemedialAction rdf:ID="_37997e71-cb7d-4a8c-baa6-2a1594956da9">
1324   <cim:IdentifiedObject.mRID>37997e71-cb7d-4a8c-baa6-2a1594956da9</cim:IdentifiedObject.mRID>
1325   <cim:IdentifiedObject.name>TapRA2</cim:IdentifiedObject.name>
1326   <cim:IdentifiedObject.description>Curative RA: TapPositionAction on normal trafo (MV Tap to 33) TapChangerID :
1327   _fe25f43a-7341-446e-a71a-8ab7119ba806</cim:IdentifiedObject.description>
1328   <nc:RemedialAction.normalAvailable>true</nc:RemedialAction.normalAvailable>
1329   <nc:RemedialAction.kind rdf:resource="https://cim4.eu/ns/nc#RemedialActionKind.curative"/>
1330   <nc:RemedialAction.isCrossBorderRelevant>false</nc:RemedialAction.isCrossBorderRelevant>
1331   <nc:RemedialAction.AppointedToRegion rdf:resource="#_ed7b43e8-ald4-45d6-984b-b9d9cb4f07c7"/>
1332 </nc:GridStateAlterationRemedialAction>
```

1333

### 1334 7.1.5.7 Overlapping Assessed Element

1335 This will be specified in the next version of the document.

### 1336 7.1.5.8 Expected Use Cases

1337 The following expected use cases are not explained in full detail. The next versions of the  
1338 document could include more details. This list is also not exhaustive.

1339

**Table 6 – Expected Use Cases Related to Assessed Element**

Name	Description	Comment
Non-overlapping XNE in a CCR	A line is XNE / secured for a CCR. CNE status can be TRUE or FALSE	consider also how element should be modelled/represented in the other CCR
Overlapping XNE in a CCR	A line is XNE / secured for a CCR. CNE status can be TRUE or FALSE and the XNE is considered overlapping for another CCR.	consider also how element should be modelled/represented in the other CCR
Excluded XNE 1	A line is EXCLUDED for a CCR because it is a e.g. powerplant line (=Internal reason). Scanned status in that CCR = TRUE or FALSE.	consider also how element should be modelled/represented in the other CCR
Excluded XNE 2	A line is EXCLUDED for a CCR (e.g. Core) because Core TSO-s agreed so (=EXCLUDED CORE reason). Scanned status in Core = TRUE or FALSE	consider also how element should be modelled/represented in the other CCR
Excluded XNE 3	A line is EXCLUDED for a CCR (e.g. Core) because it is XNE/secured for other CCR (=OTHER CCR reason). Element is overlapping. Scanned status in Core = TRUE or FALSE (Is overlapping a MUST in this case?)	consider also how element should be modelled/represented in the other CCR
Additional Scanned Element	A line (line < 220 kV) is AdditionalElement in a CCR (e.g. Core) and is Scanned for Core	consider also how element should be modelled/represented in the other CCR
Future XNE	A line is scheduled to be put into operation in Q4 of the next year as XNE/Secured in a CCR (e.g. Core)	consider also how element should be modelled/represented in the other CCR

Update of XNE region	A line is to be XNE/secured for first 6 months in a CCR (e.g. Core) and EXCLUDED-SCANNED in Other CCR. For other 6 months line is to be EXCLUDED-SCANNED in Core and XNE/secured for Other CCR. Exclusion reason is always Other CCR	
Update of XNE Limits - PATL	Update of Security Limits of Assessed Elements (PATL), valid only for specific hours	
Update of XNE Limits - TATL	Update of Security Limits of Assessed Elements (TATL), valid only for specific hours	
Re-inclusion of XNE (excluded to XNE)	A line is EXCLUDED in a CCR (e.g. Core), but for specific CROSA needs to be reincluded as XNE for Core.	
Exclusion of specific XNECs in Offline process	A combination of XNE / Contingency in a CCR (e.g. Core) that do not need to be addressed in ROSC	
Ad hoc Exclusion of specific XNEC	A combination of XNE / Contingency in a CCR (e.g. Core) that do not need to be addressed in CROSA (complete or certain hours) exceptionally because more efficiently addressed outside CROSA	

1340

1341

1342 **7.1.6 Contingency List**

1343 The Contingency List provision is illustrated in Figure 18.

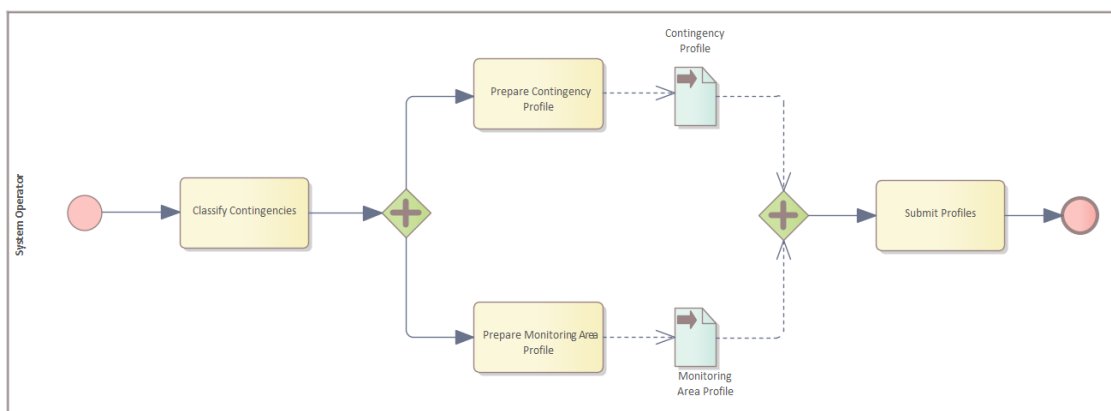

1344

**Figure 18 – Contingency list provision**

1345

1346

1347 The first step is to classify the contingencies as one of the three types illustrated in the category  
1348 diagram shown in Figure 19.  
1349

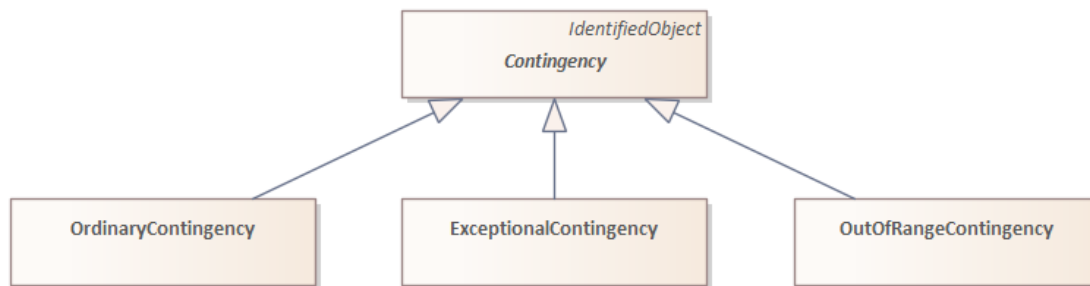

Figure 19 – Contingency category diagram

1350  
1351  
1352  
1353 Contingencies classified as ordinary and as exceptional (fulfilling the criteria specified in CSAm  
1354 art.10.1) shall be included in the Contingency List dataset. TSOs can also include external  
1355 exceptional contingencies when they potentially endanger the operational security of its  
1356 transmission system (CSAm art.10.3).

1357 The Contingency profile is the main profile used for the delivery of the contingency list dataset.  
1358 The Contingency class is instantiated to represent each contingency record in the list. Each  
1359 instance can be linked to one or more equipment (e.g., a transmission line terminal) in the  
1360 Equipment (EQ) profile through their unique mRID (Master Resource Identifier). It is possible  
1361 to define if a contingency should be considered in the security analysis by properly setting the  
1362 Contingency parameter normalMustStudy. The permanent and temporary occurrence  
1363 increasing factor types (CSAm art.8.3) for each exceptional contingency can be defined in the  
1364 ContingencyConditionKind enumeration.  
1365

1366 The specification of the external exceptional contingencies from the list is done using the  
1367 Monitoring Area profile. The external contingencies that are included in the contingency list of  
1368 a System Operator are the contingencies which are in the Contingency Area also defined using  
1369 the Monitoring Area profile. An example of monitoring area definition is provided in section  
1370 7.1.10.

1371 **7.1.6.1 Ordinary Contingency**

1372 This example illustrates how to specify an Ordinary Contingency.

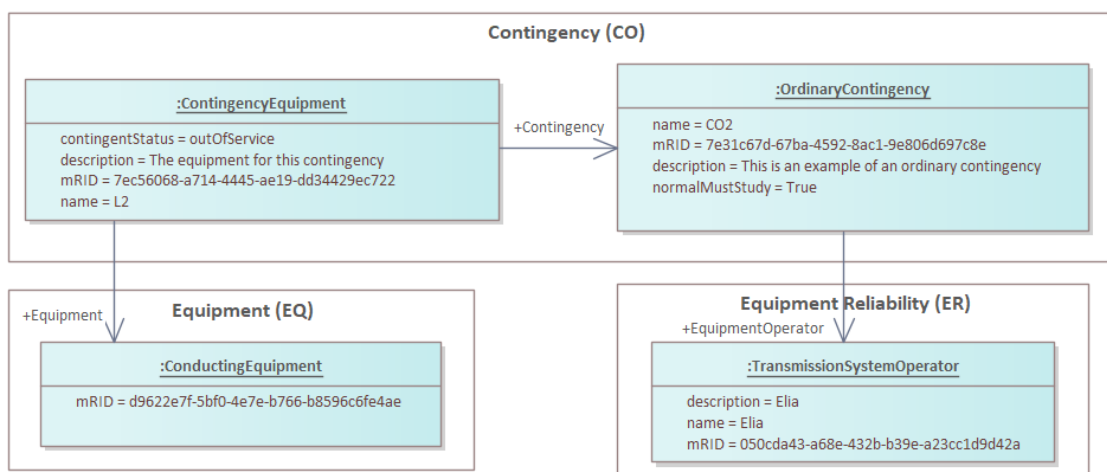

Figure 20 – Ordinary Contingency

1373  
1374 The corresponding Contingency dataset snippet is as follows.

```
1375 <nc:OrdinaryContingency rdf:ID="_7e31c67d-67ba-4592-8ac1-9e806d697c8e">
```

```

1377 <cim:IdentifiedObject.name>C02</cim:IdentifiedObject.name>
1378 <cim:IdentifiedObject.description>This is an example of an ordinary contingency;Tie Line
1379 loss</cim:IdentifiedObject.description>
1380 <cim:IdentifiedObject.mRID>7e31c67d-67ba-4592-8ac1-9e806d697c8e</cim:IdentifiedObject.mRID>
1381 <nc:Contingency.EquipmentOperator rdf:resource="#_050cda43-a68e-432b-b39e-a23cc1d9d42a"/>
1382 <nc:Contingency.normalMustStudy>true</nc:Contingency.normalMustStudy>
1383 </nc:OrdinaryContingency>
1384 <cim:ContingencyEquipment rdf:ID="_7ec56068-a714-4445-ae19-dd34429ec722">
1385 <cim:IdentifiedObject.name>L2</cim:IdentifiedObject.name>
1386 <cim:IdentifiedObject.description>The equipment for this contingency; Tie Line
1387 loss</cim:IdentifiedObject.description>
1388 <cim:IdentifiedObject.mRID>7ec56068-a714-4445-ae19-dd34429ec722</cim:IdentifiedObject.mRID>
1389 <cim:ContingencyElement.Contingency rdf:resource="#_7e31c67d-67ba-4592-8ac1-9e806d697c8e"/>
1390 <cim:ContingencyEquipment.contingencyStatus
1391 rdf:resource="https://cim.ucaiug.io/ns#ContingencyEquipmentStatusKind.outOfService"/>
1392 <cim:ContingencyEquipment.Equipment rdf:resource="#_d9622e7f-5bf0-4e7e-b766-b8596c6fe4ae"/>
1393 </cim:ContingencyEquipment>

```

1394 The Equipment Reliability dataset snippet is as follows:

```

1395 <nc:TransmissionSystemOperator rdf:ID="_050cda43-a68e-432b-b39e-a23cc1d9d42a" >
1396 <cim:IdentifiedObject.mRID>050cda43-a68e-432b-b39e-a23cc1d9d42a</cim:IdentifiedObject.mRID>
1397 <cim:IdentifiedObject.description>Elia</cim:IdentifiedObject.description>
1398 <cim:IdentifiedObject.name>Elia</cim:IdentifiedObject.name>
1399 </nc:TransmissionSystemOperator>

```

1400 The following remarks apply to this example:

- 1401 • Similar to AssessedElement, the Contingency has a logic which allows a given Contingency  
1402 to be active in the study (to be performed in a contingency analysis). The attribute  
1403 normalMustStudy in the structural data is used for this purpose.  
1404 ContingencyTimePoint.mustStudy is exchanged in the SIS dataset and  
1405 Contingency.mustStudy is exchanged in the SSI dataset. The logic presented in 7.1.3 is  
1406 followed. This is not specific for ordinary contingency and applies to all other types of  
1407 contingencies.

1408

#### 1409 7.1.6.2 Exceptional Contingency

1410 This example illustrates how to specify an Exceptional Contingency.

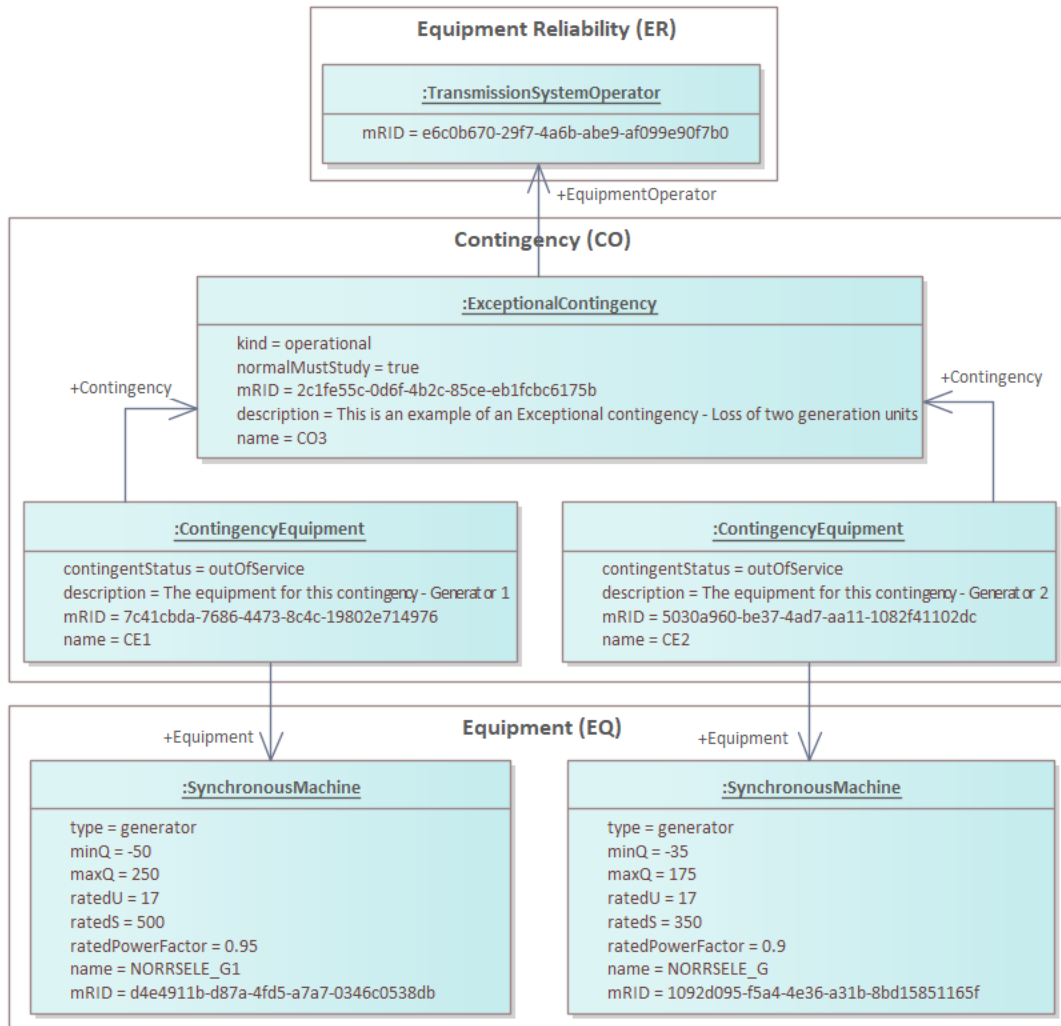

Figure 21 - Exceptional Contingency

The Contingency dataset snippet is as follows.

```

1411
1412
1413
1414 <cim:ContingencyEquipment rdf:ID="7c41cbda-7686-4473-8c4c-19802e714976">
1415 <cim:IdentifiedObject.name>CE1</cim:IdentifiedObject.name>
1416 <cim:IdentifiedObject.description>The equipment for this contingency - Generator
1417 1</cim:IdentifiedObject.description>
1418 <cim:IdentifiedObject.mRID>7c41cbda-7686-4473-8c4c-19802e714976</cim:IdentifiedObject.mRID>
1419 <cim:ContingencyElement.Contingency rdf:resource="#2c1fe55c-0d6f-4b2c-85ce-eb1fcbc6175b"/>
1420 <cim:ContingencyEquipment.contingentStatus
1421 rdf:resource="https://cim.ucaiug.io/ns#ContingencyEquipmentStatusKind.outOfService"/>
1422 <cim:ContingencyEquipment.Equipment rdf:resource="#d4e4911b-d87a-4fd5-a7a7-0346c0538db3"/>
1423 </cim:ContingencyEquipment>
1424 <cim:ContingencyEquipment rdf:ID="5030a960-be37-4ad7-aa11-1082f41102dc">
1425 <cim:IdentifiedObject.name>CE2</cim:IdentifiedObject.name>
1426 <cim:IdentifiedObject.description>The equipment for this contingency - Generator
1427 2</cim:IdentifiedObject.description>
1428 <cim:IdentifiedObject.mRID>5030a960-be37-4ad7-aa11-1082f41102dc</cim:IdentifiedObject.mRID>
1429 <cim:ContingencyElement.Contingency rdf:resource="#2c1fe55c-0d6f-4b2c-85ce-eb1fcbc6175b"/>
1430 <cim:ContingencyEquipment.contingentStatus
1431 rdf:resource="https://cim.ucaiug.io/ns#ContingencyEquipmentStatusKind.outOfService"/>
1432 <cim:ContingencyEquipment.Equipment rdf:resource="#1092d095-f5a4-4e36-a31b-8bd15851165f"/>
1433 </cim:ContingencyEquipment>
1434 <nc:ExceptionalContingency rdf:ID="2c1fe55c-0d6f-4b2c-85ce-eb1fcbc6175b">
1435 <cim:IdentifiedObject.name>CO3</cim:IdentifiedObject.name>
1436 <cim:IdentifiedObject.description>This is an example of an Exceptional contingency - Loss of two generation
1437 units</cim:IdentifiedObject.description>
1438 <cim:IdentifiedObject.mRID>2c1fe55c-0d6f-4b2c-85ce-eb1fcbc6175b</cim:IdentifiedObject.mRID>
1439 <nc:Contingency.EquipmentOperator rdf:resource="#e6c0b670-29f7-4a6b-abe9-af099e90f7b0"/>
1440 <nc:Contingency.normalMustStudy>true</nc:Contingency.normalMustStudy>
1441 <nc:ExceptionalContingency.kind rdf:resource="https://cim4.eu/ns/nc#ContingencyConditionKind.operational"/>
1442 </nc:ExceptionalContingency>
    
```

1443 The Equipment dataset snippet is as follows.

```

1444 <cim:SynchronousMachine rdf:ID="d4e4911b-d87a-4fd5-a7a7-0346c0538db3">
1445   <cim:Equipment.EquipmentContainer rdf:resource="#a7f5e1c1-d18a-473d-905f-cb13d4711d89" />
1446   <cim:IdentifiedObject.mRID>d4e4911b-d87a-4fd5-a7a7-0346c0538db3</cim:IdentifiedObject.mRID>
1447   <cim:IdentifiedObject.name>NORSELE_G1</cim:IdentifiedObject.name>
1448   <cim:RegulatingCondEq.RegulatingControl rdf:resource="#51b004dd-fb43-5c9b-85a8-3b04bd4a7f6c" />
1449   <cim:RotatingMachine.GeneratingUnit rdf:resource="#8f6d7917-dd59-b418-d4f2-58dc5fc259e3" />
1450   <cim:RotatingMachine.ratedPowerFactor>0.95</cim:RotatingMachine.ratedPowerFactor>
1451   <cim:RotatingMachine.ratedS>500</cim:RotatingMachine.ratedS>
1452   <cim:RotatingMachine.ratedU>17</cim:RotatingMachine.ratedU>
1453   <cim:SynchronousMachine.maxQ>250</cim:SynchronousMachine.maxQ>
1454   <cim:SynchronousMachine.minQ>-50</cim:SynchronousMachine.minQ>
1455   <cim:SynchronousMachine.type rdf:resource="https://cim.ucaiug.io/ns#SynchronousMachineKind.generator" />
1456 </cim:SynchronousMachine>
1457 <cim:SynchronousMachine rdf:ID="1092d095-f5a4-4e36-a31b-8bd15851165f">
1458   <cim:Equipment.EquipmentContainer rdf:resource="#a7f5e1c1-d18a-473d-905f-cb13d4711d89" />
1459   <cim:IdentifiedObject.mRID>1092d095-f5a4-4e36-a31b-8bd15851165f</cim:IdentifiedObject.mRID>
1460   <cim:IdentifiedObject.name>NORSELE_G2</cim:IdentifiedObject.name>
1461   <cim:RegulatingCondEq.RegulatingControl rdf:resource="#ee9064e4-3f25-e88e-8c7b-66763e94050a" />
1462   <cim:RotatingMachine.GeneratingUnit rdf:resource="#f899aef4-6912-8989-23e3-0fe63e1852f3" />
1463   <cim:RotatingMachine.ratedPowerFactor>0.9</cim:RotatingMachine.ratedPowerFactor>
1464   <cim:RotatingMachine.ratedS>350</cim:RotatingMachine.ratedS>
1465   <cim:RotatingMachine.ratedU>17</cim:RotatingMachine.ratedU>
1466   <cim:SynchronousMachine.maxQ>175</cim:SynchronousMachine.maxQ>
1467   <cim:SynchronousMachine.minQ>-35</cim:SynchronousMachine.minQ>
1468   <cim:SynchronousMachine.type rdf:resource="https://cim.ucaiug.io/ns#SynchronousMachineKind.generator" />
1469 </cim:SynchronousMachine>

```

1470 For simplicity, some parts of the Equipment dataset snippet are not represented in the diagram  
 1471 (e.g., association of the SynchronousMachine objects with EquipmentContainer and  
 1472 RegulatingControl objects).

1473 In line with CSAm Article 8, each TSO shall determine for each exceptional contingency the  
 1474 relevance and criteria of application of the following occurrence increasing factors:

1475 (a) permanent occurrence increasing factors

1476 (b) temporary occurrence increasing factors

1477 From ROSC perspective, the exceptional contingencies are therefore split into permanent and  
 1478 temporary exceptional contingencies. Permanent exceptional contingencies are always  
 1479 included in the Daily ROSC process while temporary exceptional contingencies are included  
 1480 only in case a TSO requests the inclusion during daily process.

1481 The distinction between permanent and temporary exceptional contingency is implemented by  
 1482 defining the ContingencyConditionKind for each ExceptionalContingency as given below:

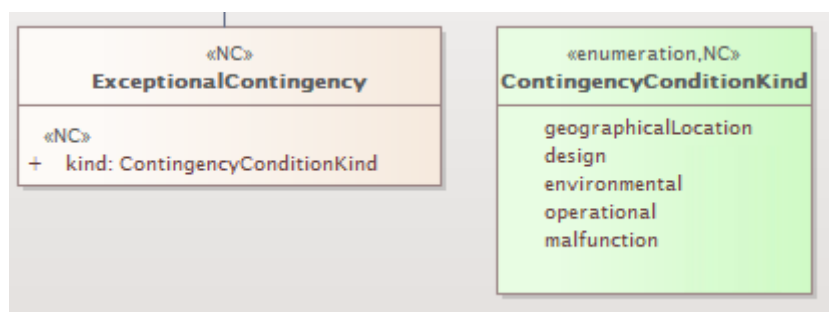

1483

1484 - Permanent exceptional contingency is defined by ContingencyConditionKind:  
 1485 geographicalLocation or design

1486 - Temporary exceptional contingency is defined by ContingencyConditionKind:  
 1487 environmental, operational or malfunction

1488 By default, for all temporary exceptional contingencies mustStudy shall be set to false in the  
 1489 structural data. Afterwards, in case it is required by TSO to include it during the daily process  
 1490 via SSI / SIS profile the value of mustStudy is changed to true for specific time period.



1491 **7.1.6.3 Out-of-range Contingency**

1492 This example illustrates how to specify an out-of-range Contingency.

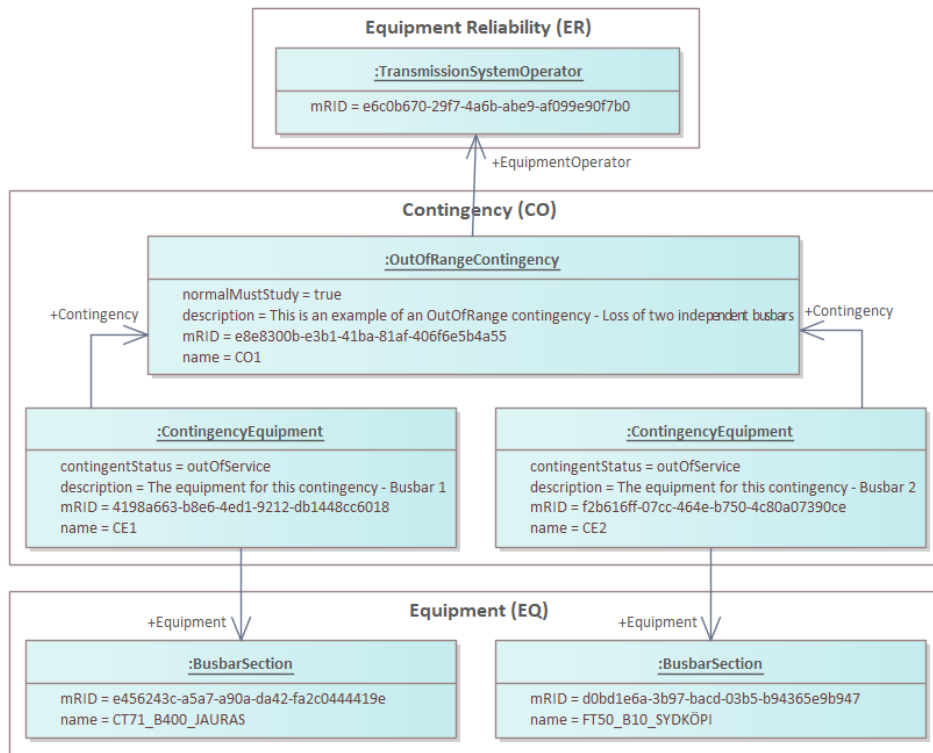

Figure 22 - Out of Range Contingency

1493

1494

1495 The Contingency dataset snippet is as follows.

```

1496 <cim:ContingencyEquipment rdf:ID="4198a663-b8e6-4ed1-9212-db1448cc6018">
1497   <cim:IdentifiedObject.name>CE1</cim:IdentifiedObject.name>
1498   <cim:IdentifiedObject.description>The equipment for this contingency - Busbar 1</cim:IdentifiedObject.description>
1499   <cim:IdentifiedObject.mRID>4198a663-b8e6-4ed1-9212-db1448cc6018</cim:IdentifiedObject.mRID>
1500   <cim:ContingencyElement.Contingency rdf:resource="#_e8e8300b-e3b1-41ba-81af-406f6e5b4a55"/>
1501   <cim:ContingencyEquipment.contingentStatus
1502     rdf:resource="https://cim.ucaiug.io/ns#ContingencyEquipmentStatusKind.outOfService"/>
1503   <cim:ContingencyEquipment.Equipment rdf:resource="#_e456243c-a5a7-a90a-da42-fa2c0444419e"/>
1504 </cim:ContingencyEquipment>
1505 <cim:ContingencyEquipment rdf:ID="f2b616ff-07cc-464e-b750-4c80a07390ce">
1506   <cim:IdentifiedObject.name>CE2</cim:IdentifiedObject.name>
1507   <cim:IdentifiedObject.description>The equipment for this contingency - Busbar 2</cim:IdentifiedObject.description>
1508   <cim:IdentifiedObject.mRID>f2b616ff-07cc-464e-b750-4c80a07390ce</cim:IdentifiedObject.mRID>
1509   <cim:ContingencyElement.Contingency rdf:resource="#_e8e8300b-e3b1-41ba-81af-406f6e5b4a55"/>
1510   <cim:ContingencyEquipment.contingentStatus
1511     rdf:resource="https://cim.ucaiug.io/ns#ContingencyEquipmentStatusKind.outOfService"/>
1512   <cim:ContingencyEquipment.Equipment rdf:resource="#_d0bd1e6a-3b97-bacd-03b5-b94365e9b947"/>
1513 </cim:ContingencyEquipment>
1514 <nc:OutOfRangeContingency rdf:ID="e8e8300b-e3b1-41ba-81af-406f6e5b4a55">
1515   <cim:IdentifiedObject.name>CO1</cim:IdentifiedObject.name>
1516   <cim:IdentifiedObject.description>This is an example of an OutOfRange contingency - Loss of two independent
1517   busbars</cim:IdentifiedObject.description>
1518   <cim:IdentifiedObject.mRID>e8e8300b-e3b1-41ba-81af-406f6e5b4a55</cim:IdentifiedObject.mRID>
1519   <nc:Contingency.EquipmentOperator rdf:resource="#_e6c0b670-29f7-4a6b-abe9-af099e90f7b0"/>
1520   <nc:Contingency.normalMustStudy>true</nc:Contingency.normalMustStudy>
1521 </nc:OutOfRangeContingency>
    
```

1522 The Equipment dataset snippet is as follows.

```

1523 <cim:BusbarSection rdf:ID="e456243c-a5a7-a90a-da42-fa2c0444419e">
1524   <cim:Equipment.EquipmentContainer rdf:resource="#_007dedc8-ce4f-4f2c-b424-bc7b8fe1da30" />
1525   <cim:IdentifiedObject.mRID>e456243c-a5a7-a90a-da42-fa2c0444419e</cim:IdentifiedObject.mRID>
1526   <cim:IdentifiedObject.name>CT71_B400_JAURAS</cim:IdentifiedObject.name>
1527 </cim:BusbarSection>
1528 <cim:BusbarSection rdf:ID="d0bd1e6a-3b97-bacd-03b5-b94365e9b947">
1529   <cim:Equipment.EquipmentContainer rdf:resource="#_8eb93370-c564-4279-9b11-57b6a3f95e5c" />
1530   <cim:IdentifiedObject.mRID>d0bd1e6a-3b97-bacd-03b5-b94365e9b947</cim:IdentifiedObject.mRID>
1531   <cim:IdentifiedObject.name>FT50_B10_SYDKÖPI</cim:IdentifiedObject.name>
1532 </cim:BusbarSection>
    
```

```

1533 <cim:VoltageLevel rdf:ID="_007dedc8-ce4f-4f2c-b424-bc7b8fe1da30">
1534 <cim:IdentifiedObject.mRID>007dedc8-ce4f-4f2c-b424-bc7b8fe1da30</cim:IdentifiedObject.mRID>
1535 <cim:IdentifiedObject.name>JAURAS_4_CT71</cim:IdentifiedObject.name>
1536 <cim:VoltageLevel.BaseVoltage rdf:resource="#_597e44dc-2a6e-4c62-82f3-f82cc46e0e14" />
1537 <cim:VoltageLevel.Substation rdf:resource="#_eb3b03b0-d562-47d9-ad7a-90a433ddc0ac" />
1538 </cim:VoltageLevel>
1539 <cim:VoltageLevel rdf:ID="_8eb93370-c564-4279-9b11-57b6a3f95e5c">
1540 <cim:IdentifiedObject.mRID>8eb93370-c564-4279-9b11-57b6a3f95e5c</cim:IdentifiedObject.mRID>
1541 <cim:IdentifiedObject.name>SYDKÖPIN_11_FT50</cim:IdentifiedObject.name>
1542 <cim:VoltageLevel.BaseVoltage rdf:resource="#_12b77529-a0cf-fed0-ae74-6912bb5fac8d" />
1543 <cim:VoltageLevel.Substation rdf:resource="#_97a2eca6-bf41-447c-8786-ca82736395d9" />
1544 </cim:VoltageLevel>
    
```

1545 For simplicity, some parts of the Equipment dataset snippet are not represented in the diagram  
 1546 (e.g., association of the SynchronousMachine objects with EquipmentContainer and  
 1547 RegulatingControl objects).

1548 **7.1.7 List of Remedial Actions**

1549 The List of Remedial Actions provision process is illustrated in Figure 23.

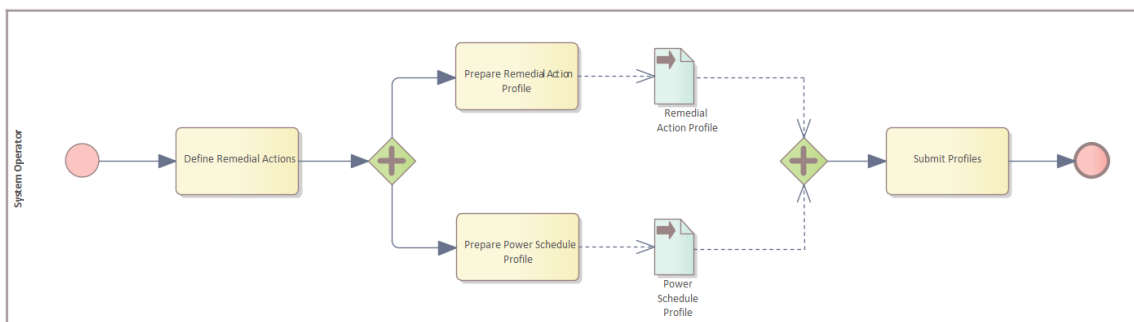

1550

1551 **Figure 23 – List of Remedial Actions provision**

1552

1553 System operator can define a set of remedial actions as part of the structural data. Once  
 1554 defined, a remedial action can be considered as available (depending on the value of  
 1555 normalAvailable and data provided in SIS or SSI datasets), in this case the remedial action  
 1556 can be considered when running the business process or unavailable in case that a remedial action  
 1557 cannot be used (upper part of Figure 24). In case that a remedial action is not needed anymore,  
 1558 once it is disabled, it can be archived for tracking and historic purposes.

1559 The Remedial Action profile is used for the provision of the list of Remedial Actions. Additionally,  
 1560 the Power Schedule profile can be used depending on the use case.

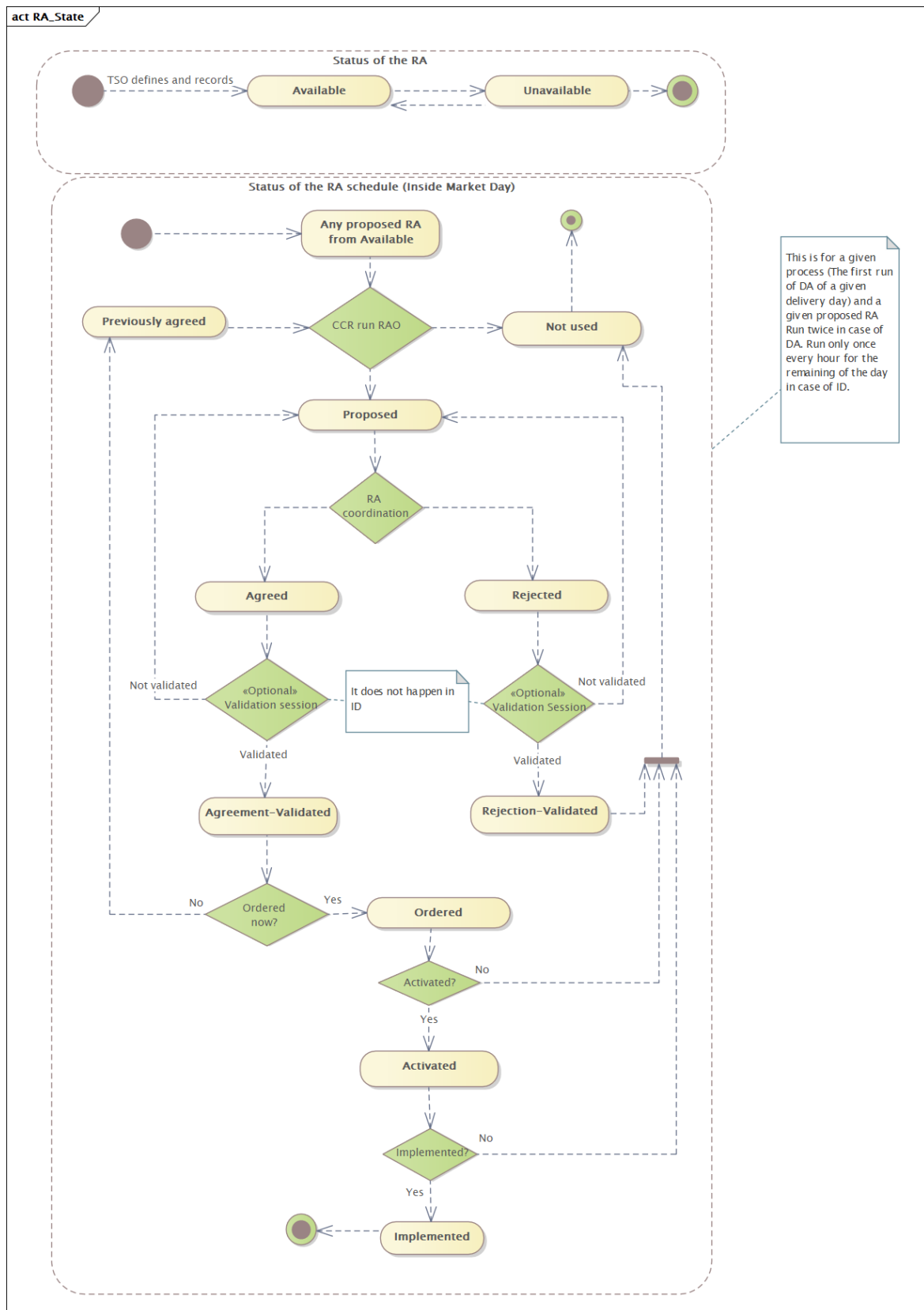

This is for a given process (The first run of DA of a given delivery day) and a given proposed RA Run twice in case of DA. Run only once every hour for the remaining of the day in case of ID.

1561

1562

1563

Figure 24 – Remedial action state diagram

1564 All available remedial actions can be used for the remedial action optimization process which  
1565 will choose the most appropriate remedial actions to solve the different issues in the scenario.  
1566 These remedial actions are denominated as proposed remedial actions.

1567 Just after the remedial action optimisation process is finished, remedial action coordination  
1568 starts. If it passes the coordination, the remedial action can be agreed or rejected. These two  
1569 states must be validated during the validation session. If they are not finally validated, they  
1570 become proposed again.

1571 In case that a rejected remedial action is validated, then it becomes Rejection-Validated. On  
1572 the other hand, if the agreed remedial action is validated, then it becomes Agreement-Validated.  
1573 Agreement-Validated remedial actions can be ordered now or in a later stage. In case that a  
1574 remedial action is not ordered now, then it becomes a previously agreed remedial action. If it is  
1575 ordered now, then the remedial action changes its status to Ordered. Ordered means that the  
1576 SO sends the order to the corresponding party to proceed with the RA, and in most cases  
1577 ordered means it is a binding order (could be that still, in an exceptional case, the RA could be  
1578 cancelled after being ordered) In case that an ordered RA is not finally activated, then it  
1579 becomes Not used. After ordered, the RA can become activated in which the forecast case is  
1580 updated with regards to the acceptance criteria. In case that an activated RA is not finally  
1581 implemented, then it becomes Not used. However, if the activated RA is implemented, then it  
1582 becomes Implemented and the process finishes.

1583 The following types of remedial actions can be defined:

- 1584 • Grid state alteration remedial action – describes one or many grid state alterations applied to a  
1585 grid model state or a particular scenario in order to resolve one or more identified constraints.
- 1586 • Scheme remedial action – involves a scheme that can include conditional logic and stages of  
1587 grid alteration. The primary remedial action is the arming of these schemes, which will then  
1588 perform curative remedial action when the condition is met. System Integrity Protection Scheme  
1589 (SIPS) and Special Protection Scheme (SPS) are example of this. Scheme remedial actions  
1590 can be coordinable or non-coordinable.
- 1591 • Redispatch remedial action - Redispatch means a measure, including curtailment, that is  
1592 activated by one or more transmission system operators or distribution system operators by  
1593 altering the generation, load pattern, or both, in order to change physical flows in the electricity  
1594 system and relieve a physical congestion or otherwise ensure system security (Regulation (EU)  
1595 2019/943). In its essence from CSA perspective, redispatch remedial action is always defined  
1596 by potential increase or decrease of power infeed in a known location, i.e. exact node of the grid  
1597 model.
- 1598 • Countertrade remedial action - Countertrade means a trade between bidding zone to solve a  
1599 congestion. Therefore, a countertrade remedial action means a measure performed by one or  
1600 several TSOs in one or several bidding zones in order to relieve physical congestions where  
1601 the location of activated resources within the bidding zone is not known. A countertrade offer by  
1602 a TSO is in general based on some existing third party bids since a TSO shall not offer  
1603 countertrade randomly and risk whether it can really provide it. Therefore, countertrade can be  
1604 associated to:
  - 1605 ○ bid from the market
  - 1606 ○ bid from tertiary energy providers (which is a control area bid, not associated to a  
1607 specific unit by its definition).

1608 A countertrade offer, which a TSO offers to RAO, consists of a merit order of MW-price blocks  
1609 which are actually individual discrete bids and shall contain additional parameters which are  
1610 currently defined in PowerBidSchedule (i.e., lead time, step increment, max activation).

1611 In order to allow correct modelling of countertrade offer within the grid model, the countertrade  
1612 remedial action is linked to a GLSK (provided in ER dataset) which defines how a change in the  
1613 balance / net position (single value) of a zone is transformed into a set of values of delta  
1614 injections in specified nodes (multiple values) of a certain grid model. By default, a countertrade  
1615 is associated to the so-called "country GSK" meaning an increase of infeed proportional to the  
1616 remaining available capacity on all generating units within a bidding zone, excluding nuclear  
1617 and renewable types.
- 1618 • Availability remedial action - cancels or reschedules an availability schedule.

1619  
1620 A remedial action can include multiple grid state alteration and this is necessary in order to  
1621 model multiple actions within one remedial action. The design depends on the business need  
1622 and the complexity of the remedial action that needs to be modelled. For instance, a topology  
1623 action would in most of the cases act on multiple switches to achieve a change in a substation  
1624 topology. In addition, remedial actions can be grouped into groups, and the dependency  
1625 between them specified.

1626  
1627 The following sections illustrate several remedial actions that are often used by system  
1628 operator.  
1629

1630 **7.1.7.1 Grid State Alteration Remedial Action – Tap position**

1631 This example illustrates how to specify a Grid State Alteration Remedial Action.

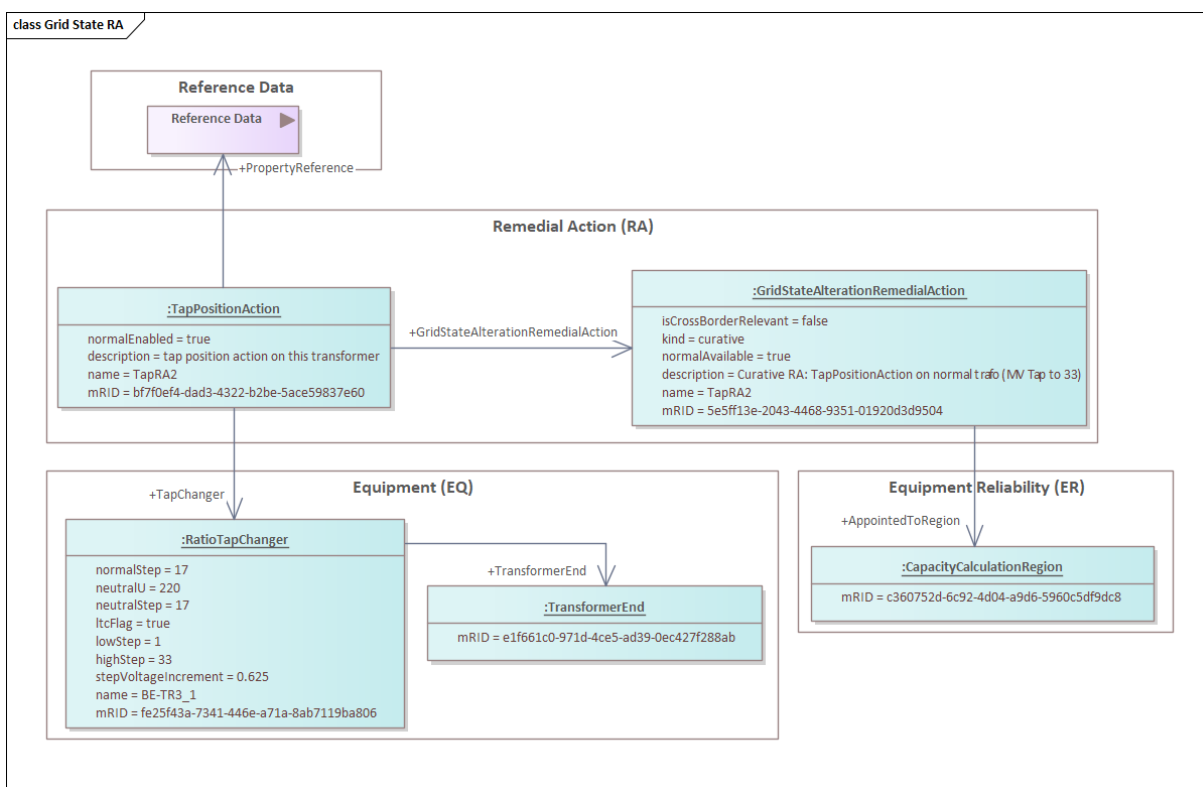

1632  
1633 **Figure 25 - Grid State Alteration (Tap Position) Example**

1634 The corresponding Remedial Action dataset snippet is as follows:

```

1635 <nc:GridStateAlterationRemedialAction rdf:ID=" 5e5ff13e-2043-4468-9351-01920d3d9504">
1636   <cim:IdentifiedObject.mRID>5e5ff13e-2043-4468-9351-01920d3d9504</cim:IdentifiedObject.mRID>
1637   <cim:IdentifiedObject.name>TapRA2</cim:IdentifiedObject.name>
1638   <cim:IdentifiedObject.description>Curative RA: TapPositionAction on normal trafo (MV Tap to 33) TapChangerID :
1639   _fe25f43a-7341-446e-a71a-8ab7119ba806</cim:IdentifiedObject.description>
1640   <nc:RemedialAction.normalAvailable>true</nc:RemedialAction.normalAvailable>
1641   <nc:RemedialAction.kind rdf:resource="https://cim4.eu/ns/nc#RemedialActionKind.curative"/>
1642   <nc:RemedialAction.isCrossBorderRelevant>false</nc:RemedialAction.isCrossBorderRelevant>
1643   <nc:RemedialAction.AppointedToRegion rdf:resource="#_c360752d-6c92-4d04-a9d6-5960c5df9dc8"/>
1644 </nc:GridStateAlterationRemedialAction>
1645 <nc:TapPositionAction rdf:ID=" bf7f0ef4-dad3-4322-b2be-5ace59837e60">
1646   <cim:IdentifiedObject.mRID>bf7f0ef4-dad3-4322-b2be-5ace59837e60</cim:IdentifiedObject.mRID>
1647   <cim:IdentifiedObject.name>TapRA2</cim:IdentifiedObject.name>
1648   <cim:IdentifiedObject.description>tap position action </cim:IdentifiedObject.description>
1649   <nc:GridStateAlteration.PropertyReference
1650   rdf:resource="https://energy.referencedata.eu/PropertyReference/TapChanger.step"/>
1651   <nc:GridStateAlteration.GridStateAlterationRemedialAction rdf:resource="# 5e5ff13e-2043-4468-9351-01920d3d9504"/>
1652   <nc:GridStateAlteration.normalEnabled>true</nc:GridStateAlteration.normalEnabled>
1653   <nc:TapPositionAction.TapChanger rdf:resource="#_fe25f43a-7341-446e-a71a-8ab7119ba806"/>
1654 </nc:TapPositionAction>
    
```

1655 The corresponding Equipment dataset snippet is as follows:

```

1656 <cim:RatioTapChanger rdf:ID=" fe25f43a-7341-446e-a71a-8ab7119ba806">
1657 <cim:IdentifiedObject.mRID>fe25f43a-7341-446e-a71a-8ab7119ba806</cim:IdentifiedObject.mRID>
1658 <cim:IdentifiedObject.name>BE-TR3_1</cim:IdentifiedObject.name>
1659 <cim:RatioTapChanger.TransformerEnd rdf:resource="#_e1f661c0-971d-4ce5-ad39-0ec427f288ab" />
1660 <cim:RatioTapChanger.stepVoltageIncrement>0.625</cim:RatioTapChanger.stepVoltageIncrement>
1661 <cim:TapChanger.highStep>33</cim:TapChanger.highStep>
1662 <cim:TapChanger.lowStep>1</cim:TapChanger.lowStep>
1663 <cim:TapChanger.ltcFlag>true</cim:TapChanger.ltcFlag>
1664 <cim:TapChanger.neutralStep>17</cim:TapChanger.neutralStep>
1665 <cim:TapChanger.neutralU>220</cim:TapChanger.neutralU>
1666 <cim:TapChanger.normalStep>17</cim:TapChanger.normalStep>
1667 </cim:RatioTapChanger>
    
```

1668 The following remarks apply to this example :

- 1669 • The diagram does not include explicit reference to the PropertyReference, but the dataset
- 1670 snippet indicates this.
- 1671 • Depending on the setup a tap position action can be constrained to only allow tap change within
- 1672 a predefined range that is different than the tap changer regulation capabilities provided in the
- 1673 power flow part of the IGM. Constraints of this character are implemented by using
- 1674 StaticPropertyRange and IntertemporalPropertyRange.

1675 **7.1.7.2 Grid State Alteration Remedial Action – Topology**

1676 The example below illustrates how to specify a Grid State Alteration Topology Remedial Action.

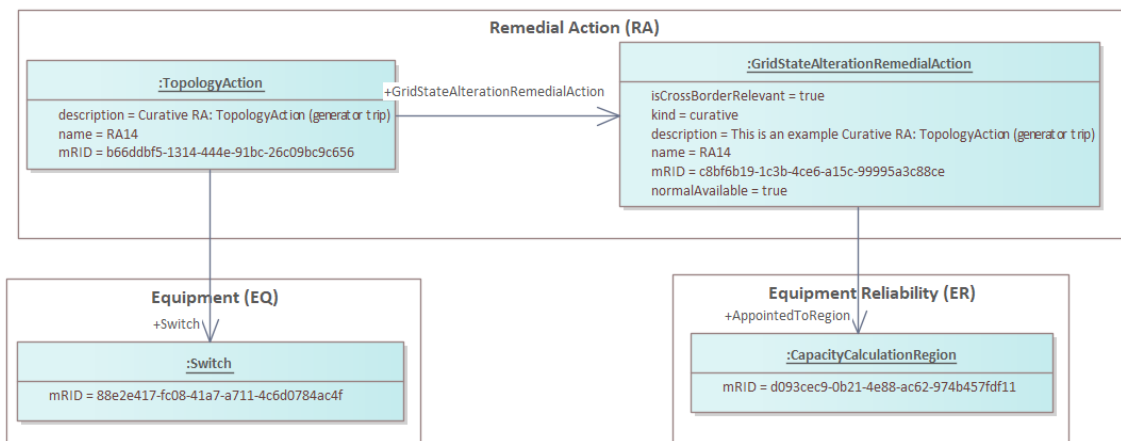

1677

1678 **Figure 26 - Grid State Alteration (Topology) Example**

1679 The corresponding Remedial Action dataset snippet is as follows:

```

1680 <nc:TopologyAction rdf:ID=" b66ddb5f5-1314-444e-91bc-26c09bc9c656">
1681 <cim:IdentifiedObject.mRID>b66ddb5f5-1314-444e-91bc-26c09bc9c656</cim:IdentifiedObject.mRID>
1682 <cim:IdentifiedObject.name>RA14</cim:IdentifiedObject.name>
1683 <cim:IdentifiedObject.description>Curative RA: TopologyAction (generator
1684 trip)</cim:IdentifiedObject.description>
1685 <nc:GridStateAlteration.PropertyReference
1686 rdf:resource="https://energy.referencedata.eu/PropertyReference/Switch.open"/>
1687 <nc:GridStateAlteration.GridStateAlterationRemedialAction rdf:resource="#_c8bf6b19-1c3b-4ce6-a15c-
1688 99995a3c88ce"/>
1689 <nc:GridStateAlteration.normalEnabled>true</nc:GridStateAlteration.normalEnabled>
1690 <nc:TopologyAction.Switch rdf:resource="#_88e2e417-fc08-41a7-a711-4c6d0784ac4f"/>
1691 </nc:TopologyAction>
1692
1693 <nc:GridStateAlterationRemedialAction rdf:ID=" c8bf6b19-1c3b-4ce6-a15c-99995a3c88ce">
1694 <cim:IdentifiedObject.mRID>c8bf6b19-1c3b-4ce6-a15c-99995a3c88ce</cim:IdentifiedObject.mRID>
1695 <cim:IdentifiedObject.name>RA14</cim:IdentifiedObject.name>
1696 <cim:IdentifiedObject.description>This is an example Curative RA: TopologyAction (generator
1697 trip)</cim:IdentifiedObject.description>
1698 <nc:RemedialAction.normalAvailable>true</nc:RemedialAction.normalAvailable>
1699 <nc:RemedialAction.kind rdf:resource="https://cim4.eu/ns/nc#RemedialActionKind.curative"/>
1700 <nc:RemedialAction.isCrossBorderRelevant>true</nc:RemedialAction.isCrossBorderRelevant>
1701 <nc:RemedialAction.AppointedToRegion rdf:resource="#_d093cec9-0b21-4e88-ac62-974b457fdf11"/>
1702 </nc:GridStateAlterationRemedialAction>
    
```

1703 The following remarks apply to this example:

- 1704
- 1705
- 1706
- 1707
- 1708
- 1709
- 1710
- 1711
- 1712
- 1713
- 1714
- 1715
- 1716
- 1717
- 1718
- 1719
- 1720
- 1721
- 1722
- It is required that topological remedial actions are modelled to act on the switches in the elements and not by indicating which element is switched. Therefore, this requires that the underlying power system model contains switching devices for at least the elements that are going to be used in topology remedial actions or any other remedial actions that require change of switching device status. This does not mean that the underlying model shall be full SCADA/EMS node-breaker model. The level of detail is driven by the need of remedial actions and the requirements in the SOGL on reporting statuses of the switching devices.
  - The TSO can design the remedial action to either provide RAO with full flexibility or constrain the action that can be performed on the switching device. For instance, a remedial action can allow for a change of the status of a switch regardless of the initial status of the switch or it can instruct to only open or only close a switch. If the remedial action is designed to only open a switch and if in the grid model the switch is already open in the SSH, RAO will not be selecting this remedial action as its implementation will be pointless. This constraints on the switching devices in case of Topology grid state alteration are defined by using StaticPropertyRange. For switching devices the attribute RangeConstraint.direction can only have values RelativeDirectionKind.upAndDown (which will allow RAO to either open or close the switch) or RelativeDirectionKind.none (which instructs RAO that only the RangeConstraint.normalValue shall be applied, i.e. is normalValue is 1, which mean Switch.open should be set to true, RAO can only open the switch if the switch is closed in the base case).

1723 The following example illustrates the usage of StaticPropertyRange to constrain a topology grid state alteration.

```

1724 <!-- Equipment Profile -->
1725 <!-- RatioTapChanger -->
1726 <cim:RatioTapChanger rdf:ID="ed8613d9-d80c-0e29-0b7f-cb7b1577631e">
1727 <cim:IdentifiedObject.mRID>ed8613d9-d80c-0e29-0b7f-cb7b1577631e</cim:IdentifiedObject.mRID>
1728 <cim:IdentifiedObject.name>63-59</cim:IdentifiedObject.name>
1729 <cim:RatioTapChanger.TransformerEnd rdf:resource="#_cadc3373-888a-1d8b-1bb5-78c353042cf8" />
1730 <cim:RatioTapChanger.stepVoltageIncrement>4</cim:RatioTapChanger.stepVoltageIncrement>
1731 <cim:TapChanger.highStep>31</cim:TapChanger.highStep>
1732 <cim:TapChanger.lowStep>1</cim:TapChanger.lowStep>
1733 <cim:TapChanger.ltcFlag>>false</cim:TapChanger.ltcFlag>
1734 <cim:TapChanger.neutralStep>16</cim:TapChanger.neutralStep>
1735 <cim:TapChanger.neutralU>220</cim:TapChanger.neutralU>
1736 <cim:TapChanger.normalStep>17</cim:TapChanger.normalStep>
1737 </cim:RatioTapChanger>
1738
1739 <!-- SV Profile initial -->
1740 <cim:SvTapStep rdf:ID="_094ff670-f9df-4a71-9880-44ac071c833d">
1741 <cim:SvTapStep.TapChanger rdf:resource="#_ed8613d9-d80c-0e29-0b7f-cb7b1577631e"/>
1742 <cim:SvTapStep.position>10</cim:SvTapStep.position>
1743 </cim:SvTapStep>
1744
1745 <!-- Remedial Action Profile -->
1746 <nc:TapPositionAction rdf:ID="dbad8bad-94a9-428a-a8d6-ef6f48490e6d">
1747 <cim:IdentifiedObject.mRID>dbad8bad-94a9-428a-a8d6-ef6f48490e6d</cim:IdentifiedObject.mRID>
1748 <cim:IdentifiedObject.name>RA16</cim:IdentifiedObject.name>
1749 <cim:IdentifiedObject.description>Curative RA: TapPositionAction</cim:IdentifiedObject.description>
1750 <nc:GridStateAlteration.PropertyReference
1751 rdf:resource="https://energy.referencedata.eu/PropertyReference/TapChanger.step"/>
1752 <nc:GridStateAlteration.GridStateAlterationRemedialAction rdf:resource="#_2e4f4212-7b30-4316-9fce-
1753 ca618f2a8a05"/>
1754 <nc:GridStateAlteration.normalEnabled>true</nc:GridStateAlteration.normalEnabled>
1755 <nc:TapPositionAction.TapChanger rdf:resource="#_ed8613d9-d80c-0e29-0b7f-cb7b1577631e"/>
1756 </nc:TapPositionAction>
1757
1758 <nc:GridStateAlterationRemedialAction rdf:ID="_2e4f4212-7b30-4316-9fce-ca618f2a8a05">
1759 <cim:IdentifiedObject.mRID>2e4f4212-7b30-4316-9fce-ca618f2a8a05</cim:IdentifiedObject.mRID>
1760 <cim:IdentifiedObject.name>RA16</cim:IdentifiedObject.name>
1761 <cim:IdentifiedObject.description>Curative RA: TapPositionAction</cim:IdentifiedObject.description>
1762 <nc:RemedialAction.normalAvailable>true</nc:RemedialAction.normalAvailable>
1763 <nc:RemedialAction.kind rdf:resource="https://cim4.eu/ns/nc#RemedialActionKind.curative"/>
1764 <nc:RemedialAction.isCrossBorderRelevant>true</nc:RemedialAction.isCrossBorderRelevant>
1765 <nc:RemedialAction.AppointedToRegion rdf:resource="https://energy.referencedata.eu/energy/EIC/10Y1001C-
1766 00059P"/>
1767 </nc:GridStateAlterationRemedialAction>
1768
1769 <nc:StaticPropertyRange rdf:ID="_451f4fdd-21ec-42c9-9386-2c42d729f01a">
1770 <cim:IdentifiedObject.mRID>451f4fdd-21ec-42c9-9386-2c42d729f01a</cim:IdentifiedObject.mRID>
1771 <cim:IdentifiedObject.name>SPR1</cim:IdentifiedObject.name>
1772 <cim:IdentifiedObject.description>StaticPropertyRange sample: restraining tap step change to a specific
1773 range</cim:IdentifiedObject.description>
1774 <nc:RangeConstraint.direction rdf:resource="https://cim4.eu/ns/nc#RelativeDirectionKind.up"/>
1775 <nc:RangeConstraint.normalValue>16</nc:RangeConstraint.normalValue>
1776 <nc:RangeConstraint.GridStateAlteration rdf:resource="#_2e4f4212-7b30-4316-9fce-ca618f2a8a05"/>
1777 <nc:GridStateAlteration.PropertyReference
1778 rdf:resource="https://energy.referencedata.eu/PropertyReference/TapChanger.step"/>
1779 <nc:RangeConstraint.valueKind rdf:resource="https://cim4.eu/ns/nc#ValueOffsetKind.absolute"/>
1780 </nc:StaticPropertyRange>

```

1781 As it can be seen in the above example, the allowed range for tap step change  
1782 (PropertyReference) is “up” (RangeConstraint.direction), which means that RAO can only apply  
1783 tap steps of “absolute” value (RangeConstraint.valueKind) of “higher than 16”  
1784 (RangeConstraint.normalValue), even though the tap changer step can physically have values  
1785 from 1 to 31 (as seen in the EQ snippet). Therefore, the new solution will not have  
1786 SvTapStep.position of 10 as given in the “initial” SV of the IGM.

### 1787 7.1.7.3 Power Remedial Actions: Countertrade and Redispatch

#### 1788 7.1.7.3.1 Design options

1789 There are four option that use different mechanisms to realise the countertrade and redispatch  
1790 remedial actions.

- 1791 • Option 1: Using grid state alteration

1792 This option relies on grid state alterations remedial actions which requires that a  
1793 GridStateAlteration is defined for each of the generating units part of the redispatch or  
1794 countertrade.

- 1795 • Option 2: Using power schedule

1796 The following classes are used:

- 1797 ○ In RemedialAction profile dataset
  - 1798 ▪ PowerRemedialAction refers to BiddingZone and/or BiddingZoneBorder
- 1799 ○ In PowerSchedule profile dataset
  - 1800 ▪ PowerSchedule objects point to PowerRemedialAction
  - 1801 ▪ One PowerSchedule object refers to one GeneratingUnit. The
  - 1802 PowerTimePoint is used to provide information on time and power (the
  - 1803 allocated power for the given point in time).

- 1804 • Option 3: Using bid schedule

1805 This is the only option where process can be assigned. The following classes are used:

- 1806 ○ In RemedialAction profile dataset
  - 1807 ▪ PowerRemedialAction refers to BiddingZone and/or BiddingZoneBorder
- 1808 ○ In StateInstructionSchedule profile dataset
  - 1809 ▪ PowerBidSchedule object that refers to PowerRemedialAction
  - 1810 ▪ PowerShiftKeyDistribution object refers to PowerBidSchedule
  - 1811 ▪ PowerBidSchedule has PowerBidScheduleTimePoint that provides the active
  - 1812 power for points in time
  - 1813 ▪ PowerShiftKeyDistribution object refers to PowerShiftKeySchedule which
  - 1814 refers to the GeneratingUnit
  - 1815 ▪ ParticipationFactorTimePoint which refers to the PowerShiftKeySchedule is
  - 1816 used to exchange the participation factors for different points in time.

- 1817 • Option 4: Using power shift key strategy

1818 The following classes are used:

- 1819 ○ In RemedialAction profile dataset
  - 1820 ▪ PowerRemedialAction refers to BiddingZone and/or BiddingZoneBorder
  - 1821 ▪ PowerShiftKeyStrategy object refers to the PowerRemedialAction
- 1822 ○ In EquipmentReliability profile dataset
  - 1823 ▪ PowerShiftKeyStrategy is defined with all the setup using SchedulingArea
- 1824 ○ In StateInstructionSchedule profile dataset
  - 1825 ▪ PowerShiftKeyDistribution object refers to PowerShiftKeySchedule object.
  - 1826 ▪ PowerShiftKeyDistribution object also refers to the PowerShiftKeyStrategy
  - 1827 object in the ER dataset. It is possible to have different
  - 1828 PowerShiftKeyStrategy per PowerShiftkeyDistribution



1829 In this option there is no need that PowerShiftKeySchedule object refers to GeneratingUnit as  
 1830 this is done via the PowerShiftKeyStrategy. There is no need to use  
 1831 ParticipationFactorTimePoint.

- 1832 • Option 5: Using bid schedule and power shift key strategy

1833 The following classes are used:

- 1834 ○ In RemedialAction profile dataset
  - 1835 ▪ PowerRemedialAction refers to BiddingZone and/or BiddingZoneBorder
  - 1836 ▪ PowerShiftKeyStrategy object refers to the PowerRemedialAction
- 1837 ○ In EquipmentReliability profile dataset
  - 1838 ▪ PowerShiftKeyStrategy class using enumeration PowerShiftKeyKind
  - 1839 ▪ SchedulingArea with corresponding references to generating unit(s) in case of
  - 1840 RedispatchRemedialAction (for CountertradeRemedialAction not mandatory)
- 1841 ○ In StateInstructionSchedule profile dataset
  - 1842 ▪ PowerBidSchedule object that refers to PowerRemedialAction
  - 1843 ▪ PowerBidSchedule has PowerBidScheduleTimePoint that provides the active
  - 1844 power and price for points in time
  - 1845 ▪ PowerShiftKeyDistribution with reference to PowerShiftKeySchedule
  - 1846 ▪ In case of ExplicitInstruction PowerShiftKeySchedule is required with
  - 1847 ParticipationFactorTimePoints and potential reference to GeneratingUnit
  - 1848 (exactly the same as stated in ER)

1849 With this approach clear distinction between structured data (offline data) and schedule data  
 1850 (e.g. daily process) is achieved since only SIS is used in daily process with reference to ER  
 1851 and RA profiles.

1852

### 1853 7.1.7.3.2 Countertrade Remedial Action

1854 This example illustrates how to define a Countertrade Remedial Action.

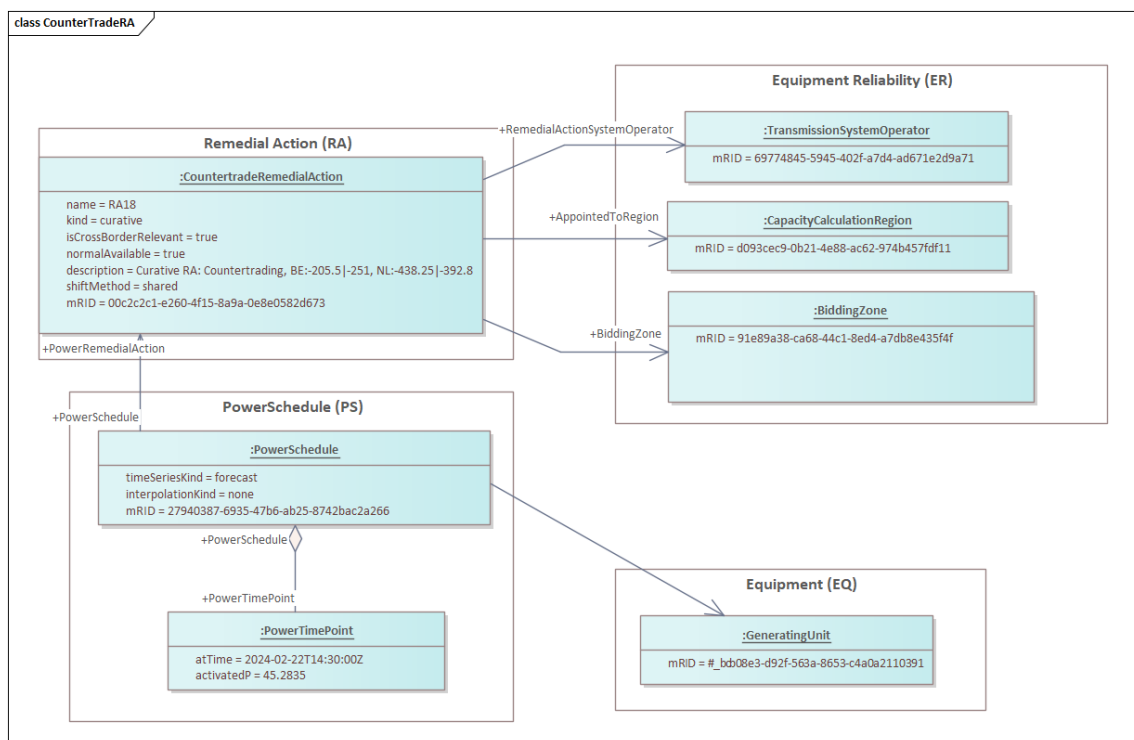

1855

1856

Figure 27 - Power Remedial Action Example with PowerSchedule

1857 The corresponding Remedial Action dataset snippet is as follows:

```

1858 <nc:CountertradeRemedialAction rdf:ID="_00c2c2c1-e260-4f15-8a9a-0e8e0582d673">
1859   <cim:IdentifiedObject.description>Curative RA: Countertrading, BE:-205.5|-251, NL:-438.25|-
1860   392.8</cim:IdentifiedObject.description>
1861   <nc:RemedialAction.normalAvailable>true</nc:RemedialAction.normalAvailable>
1862   <nc:RemedialAction.isCrossBorderRelevant>true</nc:RemedialAction.isCrossBorderRelevant>
1863   <nc:RemedialAction.AppointedToRegion rdf:resource="#_d093cec9-0b21-4e88-ac62-974b457fdf11"/>
1864   <nc:RemedialAction.kind rdf:resource="https://cim4.eu/ns/nc#RemedialActionKind.curative"/>
1865   <cim:IdentifiedObject.mRID>00c2c2c1-e260-4f15-8a9a-0e8e0582d673</cim:IdentifiedObject.mRID>
1866   <cim:IdentifiedObject.name>RA18</cim:IdentifiedObject.name>
1867   <nc:PowerRemedialAction.BiddingZone rdf:resource="#_91e89a38-ca68-44c1-8ed4-a7db8e435f4f"/>
1868   <nc:RemedialAction.RemedialActionSystemOperator
1869   ad671e2d9a71"/></nc:CountertradeRemedialAction>
    
```

1870 The corresponding PowerSchedule snippet is as follows:

```

1871 <nc:PowerSchedule rdf:ID="#_27940387-6935-47b6-ab25-8742bac2a266">
1872   <cim:IdentifiedObject.mRID>27940387-6935-47b6-ab25-8742bac2a266</cim:IdentifiedObject.mRID>
1873   <nc:PowerSchedule.PowerRemedialAction rdf:resource="#_00c2c2c1-e260-4f15-8a9a-0e8e0582d673"/>
1874   <nc:PowerSchedule.GeneratingUnit rdf:resource="#_bcb08e3-d92f-563a-8653-c4a0a2110391"/>
1875   <nc:BaseTimeSeries.timeSeriesKind rdf:resource="https://cim4.eu/ns/nc#BaseTimeSeriesKind.forecast"/>
1876   <nc:BaseTimeSeries.interpolationKind rdf:resource="https://cim4.eu/ns/nc#TimeSeriesInterpolationKind.none"/>
1877   </nc:PowerSchedule>
1878   <nc:PowerTimePoint rdf:ID="_014615b6-134c-40c3-9d1b-b4d3aa6704fc">
1879     <nc:PowerTimePoint.activatedP>45.2835</nc:PowerTimePoint.activatedP>
1880     <nc:PowerTimePoint.atTime>2024-02-22T14:30:00Z</nc:PowerTimePoint.atTime>
1881     <nc:PowerTimePoint.PowerSchedule rdf:resource="#_27940387-6935-47b6-ab25-8742bac2a266"/>
1882   </nc:PowerTimePoint>
    
```

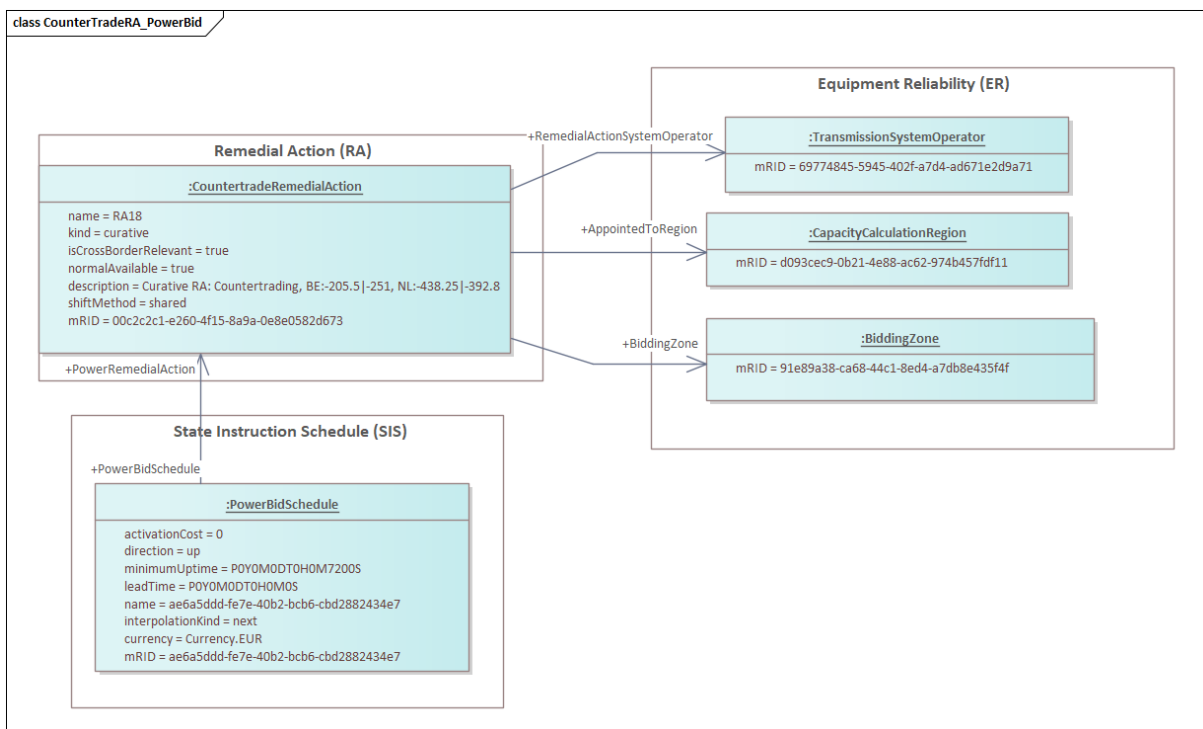

1883  
1884 **Figure 28 - Power Remedial Action Example with PowerBidSchedule**

1885 The following snippet illustrates how to specify a Countertrade remedial action by using  
1886 PowerBidSchedule concept in the SIS profile:

```

1887 <nc:PowerBidSchedule rdf:ID="_ae6a5ddd-fe7e-40b2-bcb6-cbd2882434e7">
1888   <cim:IdentifiedObject.mRID>ae6a5ddd-fe7e-40b2-bcb6-cbd2882434e7</cim:IdentifiedObject.mRID>
1889   <nc:PowerBidSchedule.currency rdf:resource="https://cim.ucaiug.io/ns#Currency.EUR"/>
1890   <nc:PowerBidSchedule.interpolationKind rdf:resource="https://cim4.eu/ns/nc#TimeSeriesInterpolationKind.next"/>
1891   <cim:IdentifiedObject.name>ae6a5ddd-fe7e-40b2-bcb6-cbd2882434e7</cim:IdentifiedObject.name>
1892   <nc:PowerBidSchedule.PowerRemedialAction rdf:resource="#_00c2c2c1-e260-4f15-8a9a-0e8e0582d673"/>
1893   <nc:PowerBidSchedule.leadTime>POYOMODTOHOM0S</nc:PowerBidSchedule.leadTime>
1894   <nc:PowerBidSchedule.minimumUptime>POYOMODTOHOM7200S</nc:PowerBidSchedule.minimumUptime>
1895   <nc:PowerBidSchedule.direction rdf:resource="https://cim4.eu/ns/nc#BidDirectionKind.up"/>
1896   <nc:PowerBidSchedule.activationCost>999.9startupCostactivationCost>0</nc:PowerBidSchedule.activationCost
1897   activationCoststartupCost>
1898   </nc:PowerBidSchedule>
1900
    
```

1901 **7.1.7.3.3 Redispatch Remedial Action**

1902 The following example illustrates two ways how to specify a Redispatch Remedial Action. Both  
1903 examples refer to the following Equipment profile snippet:

```

1904 <!-- Equipment Profile -->
1905 <cim:SynchronousMachine rdf:ID="_3a3b27be-b18b-4385-b557-6735d733baf0">
1906 <cim:Equipment.EquipmentContainer rdf:resource="#_4ba71b59-ee2f-450b-9f7d-cc2f1cc5e386" />
1907 <cim:Equipment.aggregate>false</cim:Equipment.aggregate>
1908 <cim:IdentifiedObject.description>Machine</cim:IdentifiedObject.description>
1909 <cim:IdentifiedObject.mRID>3a3b27be-b18b-4385-b557-6735d733baf0</cim:IdentifiedObject.mRID>
1910 <cim:IdentifiedObject.name>BE-G1</cim:IdentifiedObject.name>
1911 <eu:IdentifiedObject.shortName>BE-G1</eu:IdentifiedObject.shortName>
1912 <cim:RegulatingCondEq.RegulatingControl rdf:resource="#_6ba406ce-78cf-4485-9b01-a34e584f1a8d" />
1913 <cim:RotatingMachine.GeneratingUnit rdf:resource="#_18993b11-2966-4bce-bab9-d86103f83b53" />
1914 <cim:RotatingMachine.ratedPowerFactor>0.85</cim:RotatingMachine.ratedPowerFactor>
1915 <cim:RotatingMachine.ratedS>300</cim:RotatingMachine.ratedS>
1916 <cim:RotatingMachine.ratedU>10.5</cim:RotatingMachine.ratedU>
1917 <cim:SynchronousMachine.InitialReactiveCapabilityCurve rdf:resource="#_59ffe153-0e1a-44c0-ada5-7a0b3a660170" />
1918 <cim:SynchronousMachine.earthing>true</cim:SynchronousMachine.earthing>
1919 <cim:SynchronousMachine.earthingStarPointR>0</cim:SynchronousMachine.earthingStarPointR>
1920 <cim:SynchronousMachine.earthingStarPointX>0</cim:SynchronousMachine.earthingStarPointX>
1921 <cim:SynchronousMachine.ikk>0</cim:SynchronousMachine.ikk>
1922 <cim:SynchronousMachine.maxQ>300</cim:SynchronousMachine.maxQ>
1923 <cim:SynchronousMachine.minQ>-300</cim:SynchronousMachine.minQ>
1924 <cim:SynchronousMachine.mu>0</cim:SynchronousMachine.mu>
1925 <cim:SynchronousMachine.qPercent>50</cim:SynchronousMachine.qPercent>
1926 <cim:SynchronousMachine.r>0</cim:SynchronousMachine.r>
1927 <cim:SynchronousMachine.r0>0</cim:SynchronousMachine.r0>
1928 <cim:SynchronousMachine.r2>0</cim:SynchronousMachine.r2>
1929 <cim:SynchronousMachine.satDirectSubtransX>0.2</cim:SynchronousMachine.satDirectSubtransX>
1930 <cim:SynchronousMachine.satDirectSyncX>2</cim:SynchronousMachine.satDirectSyncX>
1931 <cim:SynchronousMachine.satDirectTransX>0</cim:SynchronousMachine.satDirectTransX>
1932 <cim:SynchronousMachine.shortCircuitRotorType
1933 rdf:resource="https://cim.ucaiug.io/ns#ShortCircuitRotorKind.turboSeries1" />
1934 <cim:SynchronousMachine.type rdf:resource="https://cim.ucaiug.io/ns#SynchronousMachineKind.generatorOrMotor" />
1935 <cim:SynchronousMachine.voltageRegulationRange>0</cim:SynchronousMachine.voltageRegulationRange>
1936 <cim:SynchronousMachine.x0>0.13</cim:SynchronousMachine.x0>
1937 <cim:SynchronousMachine.x2>0.171</cim:SynchronousMachine.x2>
1938 </cim:SynchronousMachine>
1939 <cim:SynchronousMachine rdf:ID="_d4e4911b-d87a-4fd5-a7a7-0346c0538db3">
1940 <cim:Equipment.EquipmentContainer rdf:resource="#_a7f5e1c1-d18a-473d-905f-cb13d4711d89" />
1941 <cim:IdentifiedObject.mRID>d4e4911b-d87a-4fd5-a7a7-0346c0538db3</cim:IdentifiedObject.mRID>
1942 <cim:IdentifiedObject.name>FR-G1</cim:IdentifiedObject.name>
1943 <cim:RegulatingCondEq.RegulatingControl rdf:resource="#_51b004dd-fb43-5c9b-85a8-3b04bd4a7f6c" />
1944 <cim:RotatingMachine.GeneratingUnit rdf:resource="#_8f6d7917-dd59-b418-d4f2-58dc5fc259e3" />
1945 <cim:RotatingMachine.ratedPowerFactor>0.95</cim:RotatingMachine.ratedPowerFactor>
1946 <cim:RotatingMachine.ratedS>500</cim:RotatingMachine.ratedS>
1947 <cim:RotatingMachine.ratedU>17</cim:RotatingMachine.ratedU>
1948 <cim:SynchronousMachine.earthing>false</cim:SynchronousMachine.earthing>
1949 <cim:SynchronousMachine.maxQ>250</cim:SynchronousMachine.maxQ>
1950 <cim:SynchronousMachine.minQ>-50</cim:SynchronousMachine.minQ>
1951 <cim:SynchronousMachine.qPercent>100</cim:SynchronousMachine.qPercent>
1952 <cim:SynchronousMachine.r>0</cim:SynchronousMachine.r>
1953 <cim:SynchronousMachine.r0>0</cim:SynchronousMachine.r0>
1954 <cim:SynchronousMachine.r2>0</cim:SynchronousMachine.r2>
1955 <cim:SynchronousMachine.satDirectSubtransX>0.2</cim:SynchronousMachine.satDirectSubtransX>
1956 <cim:SynchronousMachine.satDirectSyncX>1.1</cim:SynchronousMachine.satDirectSyncX>
1957 <cim:SynchronousMachine.shortCircuitRotorType
1958 rdf:resource="https://cim.ucaiug.io/ns#ShortCircuitRotorKind.turboSeries2" />
1959 <cim:SynchronousMachine.type rdf:resource="https://cim.ucaiug.io/ns#SynchronousMachineKind.generator" />
1960 <cim:SynchronousMachine.x0>0</cim:SynchronousMachine.x0>
1961 <cim:SynchronousMachine.x2>0.1156</cim:SynchronousMachine.x2>
1962 </cim:SynchronousMachine>

```

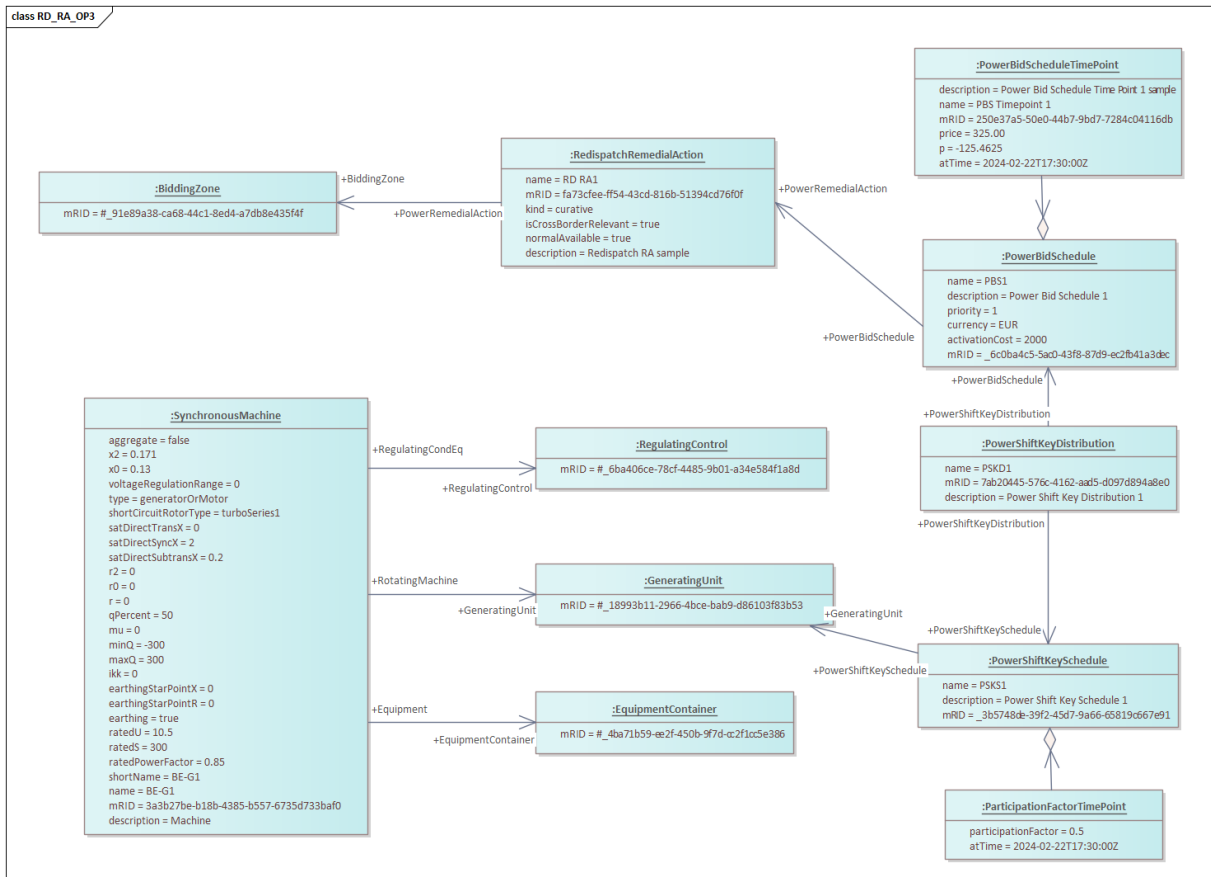

1963

1964

**Figure 29 - Redispatch Remedial Action Example Option 3**

1965

The first way illustrates the usage of the abovementioned Option 3, i.e., using bid schedules.

1966

The RemedialAction profile snippet is given below:

1967  
1968  
1969  
1970  
1971  
1972  
1973  
1974  
1975

```

<nc:RedispatchRemedialAction rdf:ID="_fa73cfee-ff54-43cd-816b-51394cd76f0f">
  <nc:PowerRemedialAction.BiddingZone rdf:resource="#_91e89a38-ca68-44c1-8ed4-a7db8e435f4f"/>
  <cim:IdentifiedObject.description>Redispatch RA sample</cim:IdentifiedObject.description>
  <nc:RemedialAction.normalAvailable>true</nc:RemedialAction.normalAvailable>
  <nc:RemedialAction.isCrossBorderRelevant>true</nc:RemedialAction.isCrossBorderRelevant>
  <nc:RemedialAction.kind rdf:resource="https://cim4.eu/ns/nc#RemedialActionKind.curative"/>
  <cim:IdentifiedObject.mRID>fa73cfee-ff54-43cd-816b-51394cd76f0f</cim:IdentifiedObject.mRID>
  <cim:IdentifiedObject.name>RD RA1</cim:IdentifiedObject.name>
</nc:RedispatchRemedialAction>
    
```

1976

The corresponding State Instruction Schedule Profile snippet is given below:

1977  
1978  
1979  
1980  
1981  
1982  
1983  
1984  
1985  
1986  
1987  
1988  
1989  
1990  
1991  
1992  
1993  
1994  
1995  
1996  
1997  
1998  
1999  
2000  
2001

```

<nc:PowerBidSchedule rdf:ID="_6c0ba4c5-5ac0-43f8-87d9-ec2fb41a3dec">
  <nc:PowerBidSchedule.activationCost>2000</nc:PowerBidSchedule.activationCost>
  <nc:PowerBidSchedule.currency rdf:resource="https://cim.ucaiug.io/ns#Currency.EUR"/>
  <nc:PowerBidSchedule.PowerRemedialAction rdf:resource="#_fa73cfee-ff54-43cd-816b-51394cd76f0f"/>
  <nc:PowerBidSchedule.priority>1</nc:PowerBidSchedule.priority>
  <cim:IdentifiedObject.description>Power Bid Schedule 1</cim:IdentifiedObject.description>
  <cim:IdentifiedObject.mRID>6c0ba4c5-5ac0-43f8-87d9-ec2fb41a3dec</cim:IdentifiedObject.mRID>
  <cim:IdentifiedObject.name>PBS1</cim:IdentifiedObject.name>
</nc:PowerBidSchedule>
<nc:PowerShiftKeyDistribution rdf:ID="_7ab20445-576c-4162-aad5-d097d894a8e0">
  <nc:PowerShiftKeyDistribution.PowerBidSchedule rdf:resource="#_6c0ba4c5-5ac0-43f8-87d9-ec2fb41a3dec"/>
  <nc:PowerShiftKeyDistribution.PowerShiftKeySchedule rdf:resource="#_3b5748de-39f2-45d7-9a66-65819c667e91"/>
  <cim:IdentifiedObject.description>Power Shift Key Distribution 1</cim:IdentifiedObject.description>
  <cim:IdentifiedObject.mRID>7ab20445-576c-4162-aad5-d097d894a8e0</cim:IdentifiedObject.mRID>
  <cim:IdentifiedObject.name>PSKD1</cim:IdentifiedObject.name>
</nc:PowerShiftKeyDistribution>
<nc:PowerShiftKeySchedule rdf:ID="_3b5748de-39f2-45d7-9a66-65819c667e91">
  <nc:PowerShiftKeySchedule.GeneratingUnit rdf:resource="#_18993b11-2966-4bce-bab9-d86103f83b53"/>
  <cim:IdentifiedObject.description>Power Shift Key Schedule 1</cim:IdentifiedObject.description>
  <cim:IdentifiedObject.mRID>3b5748de-39f2-45d7-9a66-65819c667e91</cim:IdentifiedObject.mRID>
  <cim:IdentifiedObject.name>PSKS1</cim:IdentifiedObject.name>
</nc:PowerShiftKeySchedule>
<nc:PowerBidScheduleTimePoint rdf:ID="_250e37a5-50e0-44b7-9bd7-7284c04116db">
  <nc:PowerBidScheduleTimePoint.atTime>2024-02-22T17:30:00Z</nc:PowerBidScheduleTimePoint.atTime>
  <nc:PowerBidScheduleTimePoint.PowerBidSchedule rdf:resource="#_6c0ba4c5-5ac0-43f8-87d9-ec2fb41a3dec"/>
    
```

2002  
2003  
2004  
2005  
2006  
2007  
2008  
2009  
2010  
2011  
2012  
2013  
2014  
2015

```
<nc:PowerBidScheduleTimePoint.p>-125.4625</nc:PowerBidScheduleTimePoint.p>
<nc:PowerBidScheduleTimePoint.price>325.00</nc:PowerBidScheduleTimePoint.price>
<cim:IdentifiedObject.description>Power Bid Schedule Time Point 1 sample</cim:IdentifiedObject.description>
<cim:IdentifiedObject.mRID>250e37a5-50e0-44b7-9bd7-7284c04116db</cim:IdentifiedObject.mRID>
<cim:IdentifiedObject.name>PBS Timepoint 1</cim:IdentifiedObject.name>
</nc:PowerBidScheduleTimePoint>
<nc:ParticipationFactorTimePoint rdf:ID="_06dea5a7-512e-48da-a2fc-5e0ec83a5b8e">
<nc:ParticipationFactorTimePoint.atTime>2024-02-22T17:30:00Z</nc:ParticipationFactorTimePoint.atTime>
<nc:ParticipationFactorTimePoint.participationFactor>0.5</nc:ParticipationFactorTimePoint.participationFactor>
<nc:PowerBidScheduleTimePoint.PowerShiftKeySchedule rdf:resource="#_3b5748de-39f2-45d7-9a66-65819c667e91"/>
<cim:IdentifiedObject.description>Participation Factor Time Point 1 sample</cim:IdentifiedObject.description>
<cim:IdentifiedObject.mRID>06dea5a7-512e-48da-a2fc-5e0ec83a5b8e</cim:IdentifiedObject.mRID>
<cim:IdentifiedObject.name>PF Timepoint 1</cim:IdentifiedObject.name>
</nc:ParticipationFactorTimePoint>
```

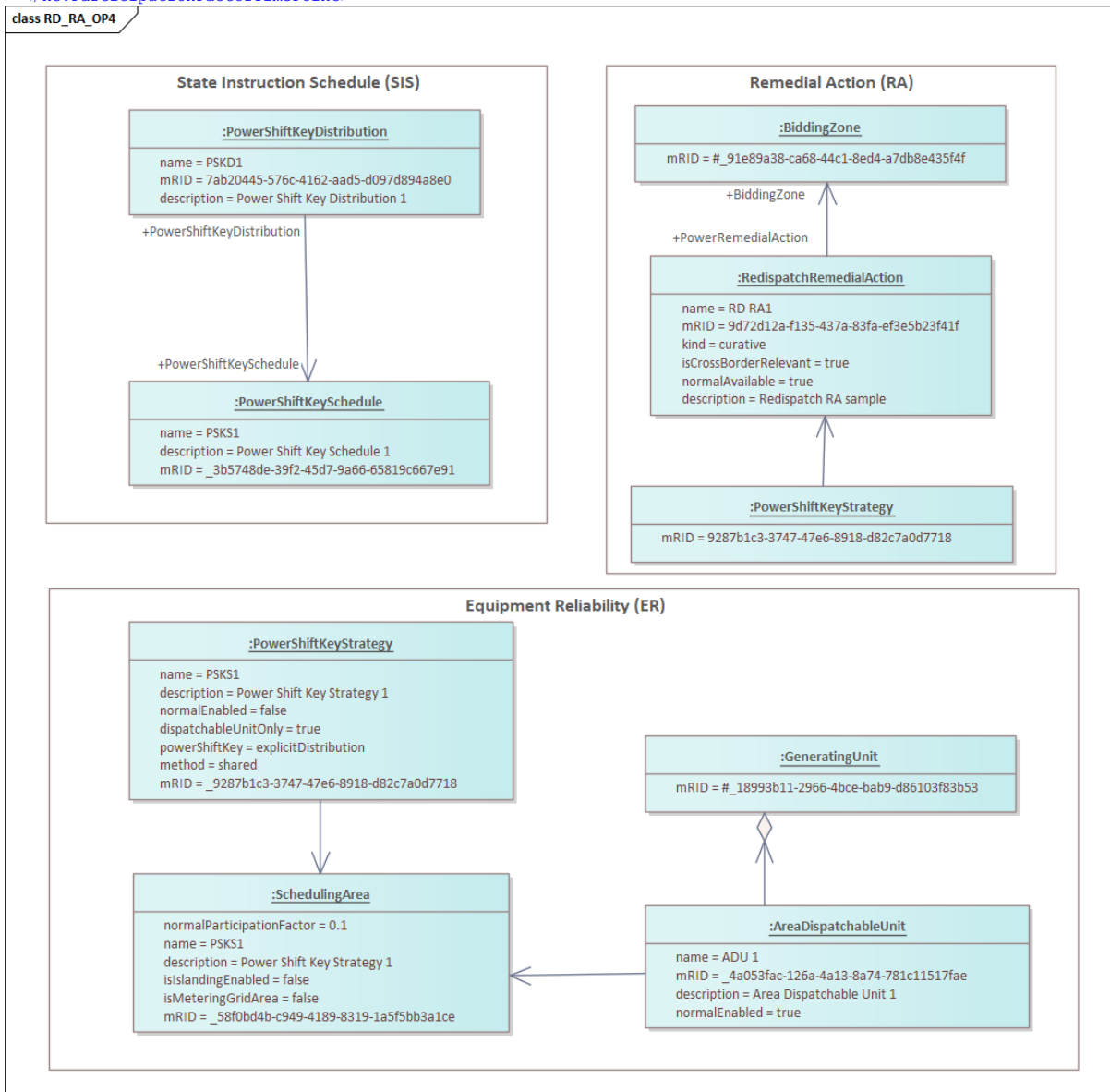

**Figure 30 - Redispatch Remedial Action Example Option 4**

The following example illustrates the way to define a RedispatchRemedialAction using power shift key strategy, as explained above in Option 4. The RemedialAction profile snippet is given below:

2016  
2017  
2018  
2019  
2020  
2021  
2022  
2023  
2024  
2025  
2026  
2027  
2028  
2029

```
<nc:RedispatchRemedialAction rdf:ID="_9d72d12a-f135-437a-83fa-ef3e5b23f41f">
<nc:PowerRemedialAction.BiddingZone rdf:resource="#_91e89a38-ca68-44c1-8ed4-a7db8e435f4f"/>
<cim:IdentifiedObject.description>Redispatch RA sample</cim:IdentifiedObject.description>
<nc:RemedialAction.normalAvailable>true</nc:RemedialAction.normalAvailable>
<nc:RemedialAction.isCrossBorderRelevant>true</nc:RemedialAction.isCrossBorderRelevant>
<nc:RemedialAction.kind rdf:resource="https://cim4.eu/ns/nc#RemedialActionKind.curative"/>
<cim:IdentifiedObject.mRID>9d72d12a-f135-437a-83fa-ef3e5b23f41f</cim:IdentifiedObject.mRID>
<cim:IdentifiedObject.name>RD RA1</cim:IdentifiedObject.name>
```

```

2030 </nc:RedispatchRemedialAction>
2031 <nc:PowerShiftKeyStrategy rdf:about="_9287b1c3-3747-47e6-8918-d82c7a0d7718">
2032 <nc:PowerShiftKeyStrategy.PowerRemedialAction rdf:resource="#_9d72d12a-f135-437a-83fa-ef3e5b23f41f"/>
2033 <cim:IdentifiedObject.mRID>9287b1c3-3747-47e6-8918-d82c7a0d7718</cim:IdentifiedObject.mRID>
2034 </nc:PowerShiftKeyStrategy>

```

2035 The corresponding Equipment Reliability profile snippet is given below:

```

2036 <nc:PowerShiftKeyStrategy rdf:ID="_9287b1c3-3747-47e6-8918-d82c7a0d7718">
2037 <nc:PowerShiftKeyStrategy.SchedulingArea rdf:resource="#_58f0bd4b-c949-4189-8319-1a5f5bb3alce"/>
2038 <nc:PowerShiftKeyStrategy.method rdf:resource="https://cim4.eu/ns/nc#ShiftMethodKind.shared"/>
2039 <nc:PowerShiftKeyStrategy.powerShiftKey
2040 rdf:resource="https://cim4.eu/ns/nc#PowerShiftKeyKind.explicitDistribution"/>
2041 <nc:PowerShiftKeyStrategy.dispatchableUnitOnly>true</nc:PowerShiftKeyStrategy.dispatchableUnitOnly>
2042 <nc:PowerShiftKeyStrategy.normalEnabled>false</nc:PowerShiftKeyStrategy.normalEnabled>
2043 <cim:IdentifiedObject.description>Power Shift Key Strategy 1</cim:IdentifiedObject.description>
2044 <cim:IdentifiedObject.mRID>9287b1c3-3747-47e6-8918-d82c7a0d7718</cim:IdentifiedObject.mRID>
2045 <cim:IdentifiedObject.name>PSKS1</cim:IdentifiedObject.name>
2046 </nc:PowerShiftKeyStrategy>
2047 <nc:SchedulingArea rdf:ID="_58f0bd4b-c949-4189-8319-1a5f5bb3alce">
2048 <nc:SchedulingArea.isMeteringGridArea>true</nc:SchedulingArea.isMeteringGridArea>
2049 <nc:SchedulingArea.isIslandingEnabled>false</nc:SchedulingArea.isIslandingEnabled>
2050 <nc:SchedulingArea.normalParticipationFactor>0.1</nc:SchedulingArea.normalParticipationFactor>
2051 <cim:IdentifiedObject.description>Scheduling Area 1</cim:IdentifiedObject.description>
2052 <cim:IdentifiedObject.mRID>58f0bd4b-c949-4189-8319-1a5f5bb3alce</cim:IdentifiedObject.mRID>
2053 <cim:IdentifiedObject.name>SA 1</cim:IdentifiedObject.name>
2054 </nc:SchedulingArea>
2055 <nc:AreaDispatchableUnit rdf:ID="_4a053fac-126a-4a13-8a74-781c11517fae">
2056 <nc:AreaDispatchableUnit.GeneratingUnit rdf:resource="#_18993b11-2966-4bce-bab9-d86103f83b53"/>
2057 <nc:AreaDispatchableUnit.normalEnabled>true</nc:AreaDispatchableUnit.normalEnabled>
2058 <nc:AreaDispatchableUnit.SchedulingArea rdf:resource="#_58f0bd4b-c949-4189-8319-1a5f5bb3alce"/>
2059 <cim:IdentifiedObject.description>Area Dispatchable Unit 1</cim:IdentifiedObject.description>
2060 <cim:IdentifiedObject.mRID>4a053fac-126a-4a13-8a74-781c11517fae</cim:IdentifiedObject.mRID>
2061 <cim:IdentifiedObject.name>ADU 1</cim:IdentifiedObject.name>
2062 </nc:AreaDispatchableUnit>
2063 </nc:AreaDispatchableUnit>
2064

```

2065 The corresponding State Instruction Schedule profile snippet is given below:

```

2066 <nc:PowerShiftKeyDistribution rdf:ID="_7ab20445-576c-4162-aad5-d097d894a8e0">
2067 <nc:PowerShiftKeyDistribution.PowerShiftKeyStrategy rdf:resource="#_9287b1c3-3747-47e6-8918-d82c7a0d7718"/>
2068 <nc:PowerShiftKeyDistribution.PowerShiftKeySchedule rdf:resource="#_3b5748de-39f2-45d7-9a66-65819c667e91"/>
2069 <cim:IdentifiedObject.description>Power Shift Key Distribution 1</cim:IdentifiedObject.description>
2070 <cim:IdentifiedObject.mRID>7ab20445-576c-4162-aad5-d097d894a8e0</cim:IdentifiedObject.mRID>
2071 <cim:IdentifiedObject.name>PSKD1</cim:IdentifiedObject.name>
2072 </nc:PowerShiftKeyDistribution>
2073 <nc:PowerShiftKeySchedule rdf:ID="_3b5748de-39f2-45d7-9a66-65819c667e91">
2074 <cim:IdentifiedObject.description>Power Shift Key Schedule 1</cim:IdentifiedObject.description>
2075 <cim:IdentifiedObject.mRID>3b5748de-39f2-45d7-9a66-65819c667e91</cim:IdentifiedObject.mRID>
2076 <cim:IdentifiedObject.name>PSKS1</cim:IdentifiedObject.name>
2077 </nc:PowerShiftKeySchedule>
2078
2079

```

#### 2080 7.1.7.4 Availability Remedial Action

2081 Availability remedial action is a remedial action that cancels or reschedules an availability  
2082 schedule. It is used when it is desired to cancel or shorten an outage.

2083 The following example illustrates how to define an Availability Remedial Action. To define an  
2084 availability remedial action, it is required to define AvailabilitySchedule which is defined in the  
2085 AvailabilitySchedule dataset.

2086 Availability remedial action can also use availability schedule for defining changes in the  
2087 operational limits by using the class AvailabilityExceptionalLimit. This can be used, for instance,  
2088 for enabling or disabling the current limit on ACLineSegment terminal in combination with other  
2089 availability functions with the same availability schedule or de-rating due to fault. It is not  
2090 recommended to use this approach to just provide new set of limits that can be provided by  
2091 using Steady State Hypothesis profile.

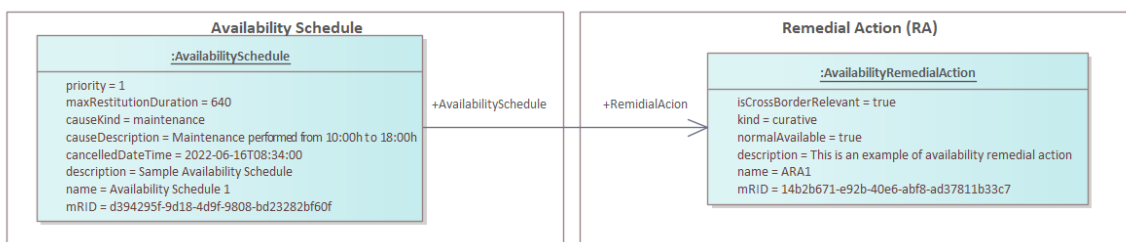

2092

2093

**Figure 31 - Availability Schedule Remedial Action Example**

2094

The corresponding Availability Schedule dataset snippet is as follows:

2095  
2096  
2097  
2098  
2099  
2100  
2101  
2102  
2103  
2104  
2105  
2106  
2107  
2108

```
<nc:AvailabilitySchedule rdf:ID=" d394295f-9d18-4d9f-9808-bd23282bf60f">
  <cim:IdentifiedObject.mRID>d394295f-9d18-4d9f-9808-bd23282bf60f</cim:IdentifiedObject.mRID>
  <cim:IdentifiedObject.name>Availability Schedule 1</cim:IdentifiedObject.name>
  <cim:IdentifiedObject.description>Sample Availability Schedule</cim:IdentifiedObject.description>
  <nc:AvailabilitySchedule.cancelledDateTime>2022-06-16T08:34:00Z</nc:AvailabilitySchedule.cancelledDateTime>
  <nc:AvailabilitySchedule.causeDescription>Maintenance performed from 10:00h to
  18:00h</nc:AvailabilitySchedule.causeDescription>
  <nc:AvailabilitySchedule.causeKind
  rdf:resource="https://cim4.eu/ns/nc#AvailabilityScheduleCauseKind.maintenance"/>
  <nc:AvailabilitySchedule.maxRestitutionDuration>640</nc:AvailabilitySchedule.maxRestitutionDuration>
  <nc:AvailabilitySchedule.priority>1</nc:AvailabilitySchedule.priority>
  <nc:AvailabilitySchedule.RemedialAction rdf:resource="#_14b2b671-e92b-40e6-abf8-ad37811b33c7"/>
</nc:AvailabilitySchedule>
```

2109

The corresponding Remedial Action dataset snippet is as follows:

2110  
2111  
2112  
2113  
2114  
2115  
2116  
2117  
2118

```
<nc:AvailabilityRemedialAction rdf:ID=" _14b2b671-e92b-40e6-abf8-ad37811b33c7">
  <cim:IdentifiedObject.mRID>14b2b671-e92b-40e6-abf8-ad37811b33c7</cim:IdentifiedObject.mRID>
  <cim:IdentifiedObject.name>ARA1</cim:IdentifiedObject.name>
  <cim:IdentifiedObject.description>This is an example of availability remedial
  action</cim:IdentifiedObject.description>
  <nc:RemedialAction.normalAvailable>true</nc:RemedialAction.normalAvailable>
  <nc:RemedialAction.kind rdf:resource="https://cim4.eu/ns/nc#RemedialActionKind.curative"/>
  <nc:RemedialAction.isCrossBorderRelevant>true</nc:RemedialAction.isCrossBorderRelevant>
</nc:AvailabilityRemedialAction>
```

2119

**7.1.7.5 Remedial Action with Dependencies**

2120  
2121  
2122

Remedial action profile enables definition of a remedial action dependency. This is realised by using the RemedialActionDependency. The dependency can be of different kind and applies to all remedial actions that have dependencies and are included in a RemedialActionGroup.

2123  
2124  
2125  
2126

One use case of using this dependency mechanism is when remedial actions from multiple TSOs are to be treated as one Remedial Action, e.g., the so-called DC-loop in the HANSA region, where two HVDC must be regulated at the same time when the remedial action is activated.

2127

This example will be elaborated more in detail in the next version of the document.

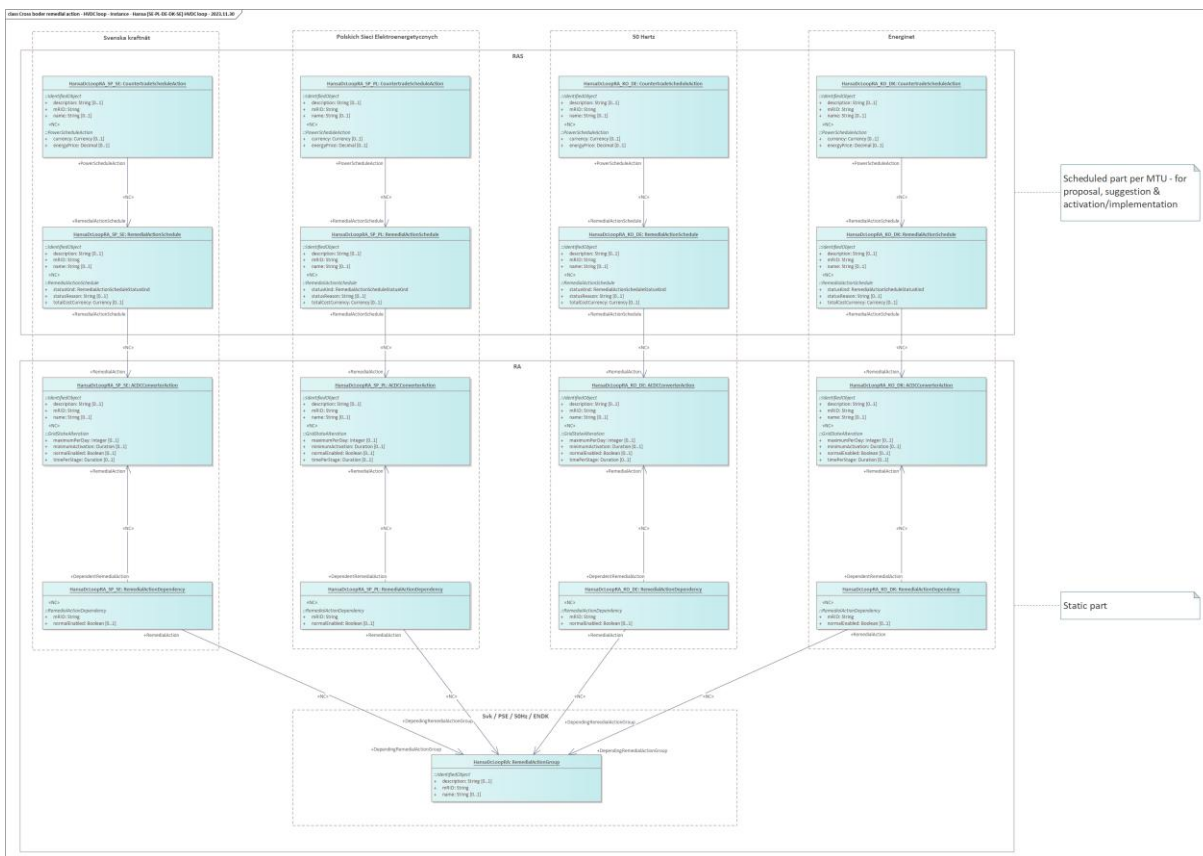

2128

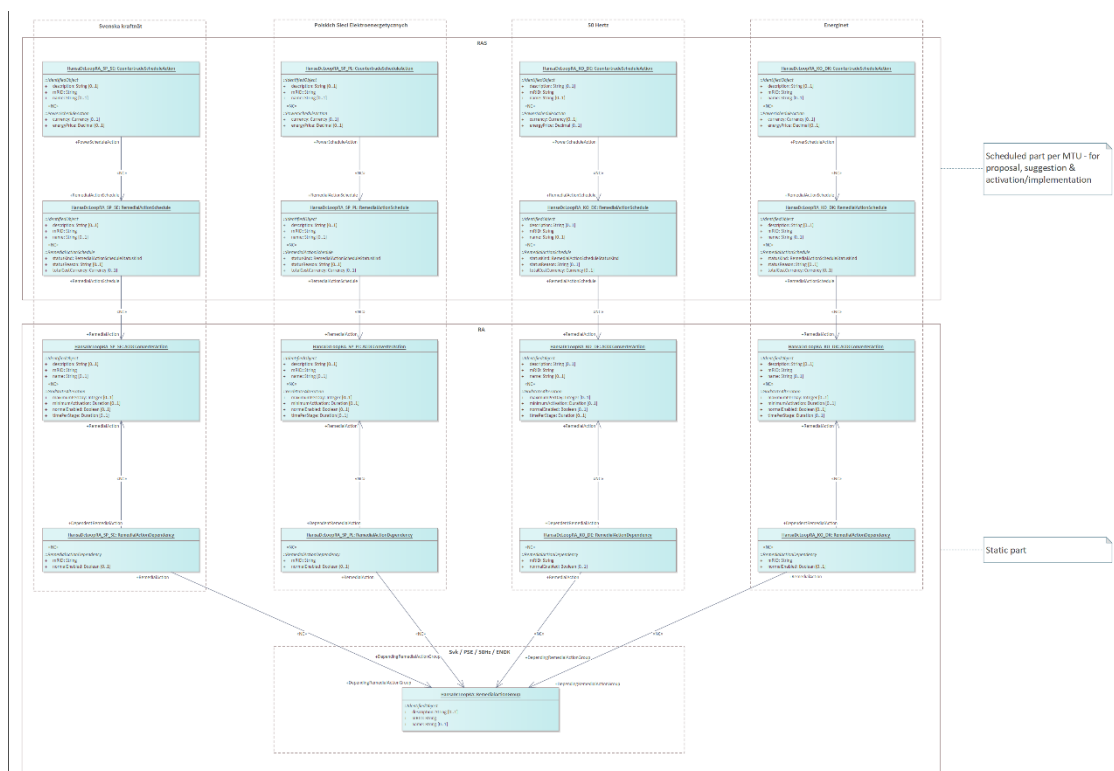

2129

2130

2131

Figure 32 – Remedial Action with Dependencies – HVDC case



### 2132 7.1.7.6 Contingency with Remedial Action

2133 This section defines how to cover different use cases that require specification of a Contingency  
2134 (CO) with a Remedial Action (RA). The following uses cases are covered:

2135 1) **Full scope:** All defined and enabled remedial actions are considered when resolving a  
2136 violation of an assessed element after a contingency.

2137 2) **Limited inclusion:** One or limited number of remedial actions are considered (the only  
2138 RA that are applicable) when resolving a violation of an assessed element after a  
2139 contingency.

2140 3) **Limited exclusion:** One or limited number of remedial actions are not considered when  
2141 resolving a violation of an assessed element after a contingency. For instance, "RA1" is  
2142 excluded, i.e., not considered/not used as possible RA, when "AE1" or "AE2" are having  
2143 violations for "CO1".

2144 4) **Consideration:** One or limited number of remedial actions can be considered when  
2145 resolving a violation of an assessed element after a contingency.

2146 The following general remarks apply to the design of the included, excluded, or considered  
2147 remedial actions with contingency:

2148 • The objective is to minimize the data exchanged for the business process, but at the  
2149 same time give guidance to the RAO in order to help the performance of the business  
2150 process. In general, all remedial actions can be considered for all assessed elements,  
2151 but this would take significant amount of time. Therefore, the data model provides a  
2152 mechanism to help limiting cases to be studied.

2153 • It should be noted that constraining RAO by limiting the possibilities on which remedial  
2154 actions can be used for resolving violations on assessed elements can be considered a  
2155 breach of the requirements defined in Network Codes and methodologies. Therefore, it  
2156 should only be used in cases where this helps the performance of the process but does  
2157 not limit the effect of optimising remedial actions and finding the best possible solution.

2158 • Contingencies can be referenced by remedial actions and/or assessed elements which  
2159 helps to minimize computational efforts when performing contingency analysis during  
2160 remedial action optimization and the business processes in general. For additional  
2161 details, refer to 7.1.5.6 on combinations between assessed element and remedial  
2162 action.

2163 The link between contingency and remedial action is provided in the exchange of remedial  
2164 actions and the link with assessed element is defined in the exchange of assessed elements.  
2165 This means that in case some specific combinations need to be defined, contingency objects  
2166 should be defined prior to the definition of the combinations with assessed elements and  
2167 remedial actions. In case a TSO applies the design in which contingencies are relevant for all  
2168 assessed elements and remedial actions (i.e., no explicit combinations), there is no explicit  
2169 dependency between the process of contingencies creation and the processes of defining  
2170 assessed elements and remedial actions.

2171 The example below illustrates how to specify a Remedial Action that is to be applied when a  
2172 specific Contingency occurs.

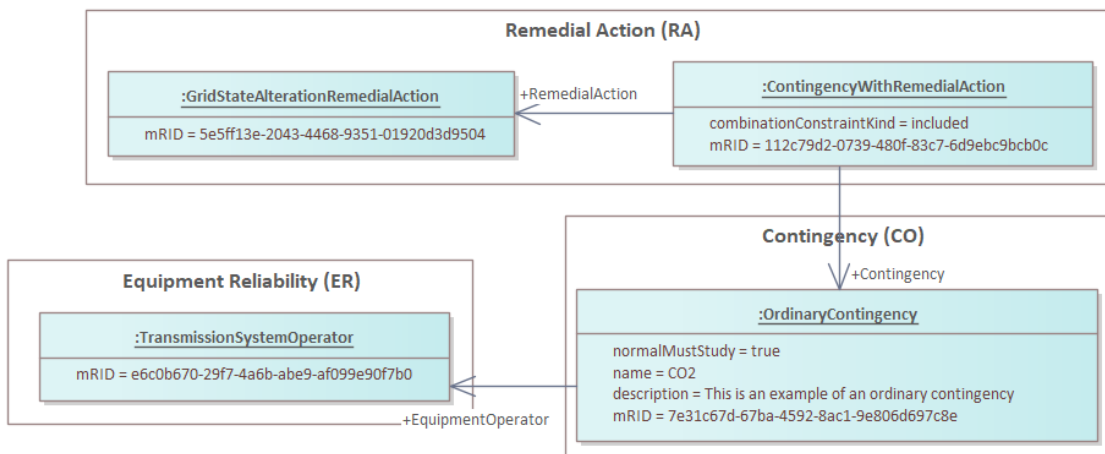

2173

2174

**Figure 33 – Remedial Action with Contingency**

2175

The corresponding Remedial Action dataset snippet is as follows:

2176  
2177  
2178  
2179  
2180  
2181  
2182  
2183  
2184  
2185  
2186  
2187  
2188  
2189  
2190  
2191  
2192  
2193  
2194  
2195

```
<nc:GridStateAlterationRemedialAction rdf:ID="_5e5ff13e-2043-4468-9351-01920d3d9504">
  <cim:IdentifiedObject.mRID>5e5ff13e-2043-4468-9351-01920d3d9504</cim:IdentifiedObject.mRID>
  <cim:IdentifiedObject.name>TapRA2</cim:IdentifiedObject.name>
  <cim:IdentifiedObject.description>Curative RA: TapPositionAction on normal trafo (MV Tap to 33)
</cim:IdentifiedObject.description>
  <nc:RemedialAction.normalAvailable>true</nc:RemedialAction.normalAvailable>
  <nc:RemedialAction.kind rdf:resource="https://cim4.eu/ns/nc#RemedialActionKind.curative"/>
  <nc:RemedialAction.isCrossBorderRelevant>false</nc:RemedialAction.isCrossBorderRelevant>
  <nc:RemedialAction.AppointedToRegion rdf:resource="#_963d6f71-b3af-448e-864d-af326edia577"/>
</nc:GridStateAlterationRemedialAction>

<nc:ContingencyWithRemedialAction rdf:ID="_112c79d2-0739-480f-83c7-6d9ebc9bcb0c">
  <nc:ContingencyWithRemedialAction.mRID>112c79d2-0739-480f-83c7-6d9ebc9bcb0c</nc:ContingencyWithRemedialAction.mRID>
  <nc:ContingencyWithRemedialAction.combinationConstraintKind
rdf:resource="https://cim4.eu/ns/nc#ElementCombinationConstraintKind.included"/>
  <nc:ContingencyWithRemedialAction.RemedialAction rdf:resource="#_5e5ff13e-2043-4468-9351-01920d3d9504"/>
  <nc:ContingencyWithRemedialAction.Contingency rdf:resource="#_7e31c67d-67ba-4592-8ac1-9e806d697c8e"/>
</nc:ContingencyWithRemedialAction>
```

2196

The Contingency dataset snippet is as follows:

2197  
2198  
2199  
2200  
2201  
2202  
2203  
2204  
2205

```
<nc:OrdinaryContingency rdf:ID="_7e31c67d-67ba-4592-8ac1-9e806d697c8e">
  <cim:IdentifiedObject.name>CO2</cim:IdentifiedObject.name>
  <cim:IdentifiedObject.description>This is an example of an ordinary contingency; Tie Line
loss</cim:IdentifiedObject.description>
  <cim:IdentifiedObject.mRID>7e31c67d-67ba-4592-8ac1-9e806d697c8e</cim:IdentifiedObject.mRID>
  <nc:Contingency.EquipmentOperator rdf:resource="#_e6c0b670-29f7-4a6b-abe9-af099e90f7b0"/>
  <nc:Contingency.normalMustStudy>true</nc:Contingency.normalMustStudy>
</nc:OrdinaryContingency>
```

2206

**7.1.7.7 Expected Use Cases**

2207

The following expected use cases are not explained in full detail. The next versions of the document could include more details. The list of use cases is not exhaustive.

2209

**Table 7 – Expected Use Cases Related to Remedial Action.**

2210

Name	Description	Comment
Preventive and curative topological RAs	Defining a RA as both preventive and curative with the same resulting switching state.	Due to the structure of the NC profiles, two different RAs (preventive and curative) with the same resulting switching state need to be defined.
Open busbar coupler and move a line from one Busbar to another	Defining a RA with opening the Busbar coupler (in order to create 2 different nodes) and	

	performing reconfiguration of a line.	
Opening busbar coupler	Opening a busbar coupler (preventive), no dependency to another switch needed	
Open/close of a single grid element - preventive	Switching on/off a single line / transformer as a topological RA. (Preventive)	
Open/close of a single grid element - curative	Switching on/off a single line / transformer as a topological RA. (Curative)	
Combination of topological actions - exclusive relationship	Two different RAs in the same substation but cannot be applied at the same time due to some technical or operational constraint	
Tap change on a power transformer as RA	Changing the tap position on a power transformer as RA	
SSSC (static synchronous series compensator)	Using SSSC's capability of changing the current on a specific line as an RA to reduce the flows on a congested grid element	The way of modelling the RA use case is highly depending on how the SSSC is modelled in the power flow part of the IGM. The SSSC is covered in detail in the ER profile part of the NC profiles.
Switching on a grid element with restitution time	Switching on a grid element in maintenance with restitution time. (preventive)	
Bypassing a PST in base case	Open one or several switches to bypass a PST	
Bypassing a PST after contingency	Open one or several switches to bypass a PST after a specific contingency occurs	
Modelling of Topological RAs with bus-branch IGMs	Modelling all the abovementioned use cases in a bus-branch case	This requires either modification of the grid model creation process or a post processing where the switches are added model and kept persistent.
PST taps preventive RA	Changing PST taps in a predefined range in a preventive way in base case	
PST taps curative RA	Changing PST taps in a predefined range in a curative way after contingency	
Target flow	Aiming for a maximal target flow in base case/after contingency, automatic change of taps to keep the flow under a predefined threshold	
Parallel PST operation	Two or more PSTs are operated in parallel; the PSTs are grouped so the tap change on each unit is the same	
PST with simultaneous preventive RA and curative RA	Two RAs, one preventive and the other curative, pointing to the same PST.	

PST action for PST groups	Asymmetrical tap changes of 4 parallel PSTs during voltage control	PSTs should be grouped into different groups and subgroups with appropriate availability flags
Single generating plant providing preventive redispatch volumes	Preventive RA on a generating plant connected to a single node capable of providing positive and negative active power	
Parent Child (one generating unit, two modes)	Different operation modes of combined-cycle power plants	
Parent Child (two generating units)	Generators not allowed to start simultaneously	
Group combined minimum/maximum infeed	Restriction of the sum power for a group of generators connected to a same node (e.g. in case of power plant line outage).	
Preventive RA pump storage	Preventive RA on a Pump Storage Power Plant with 2 modes for PGM - generating and pump mode, where Pmin and Pmax and other offline parameters are defined separately for each mode.	
Already realized redispatch (before DA CROSA)	Already ordered RA, as offline data to be linked with the RA schedule afterwards, but the volumes / prices are adapted according to what was already ordered.	
Curative redispatch with predefined pairs of single generating plants	Predefined pair of curative RD is triggered for a single contingency case	
Curative redispatch compensated by countertrade in the same bidding zone	Curative redispatch compensated by countertrade located in the bidding zone where the RA is activated for a single contingency case (simulating aFRR)	The constraints related to balancing the system still apply to these curative RAs. This balance is achieved via compensation by a slack distribution located in the bidding zone where the curative RA is activated.
Countertrade with multiple steps and a single GLSK	Single countertrade offer by a TSO covering 24 hours, expressed in price-MWh/h steps/pairs, associating a GLSK defined as proportional to the remaining available capacity (pro-rata distribution based on headroom) at all generator nodes in the TSO grid model	
Single nodal offer with multiple steps for different hours	Single-node offer which consists of MWh max, min step size defined for each power bid schedule, Pmin, Pmax defined for the Generator itself	

	(structural data and underlying model) and a number of MWh-EUR steps covering different hours during the day	
Hydro pump with parent-child generation with time shift	Single step hydro pump with the parent-child bid defined in opposite directions for a specific time shift	
Simple countertrade preventive	Potential of countertrade upwards/downwards with a single price of activation in base case	
Simple countertrade curative	Potential of countertrade upwards/downwards with a single price of activation after contingency	
Redispatch without TSO balancing	Potential from Reduction of renewable infeed which does not need balancing from TSO side	
Preventive redispatch with predefined group of loads	Preventive redispatch action where the redispatch potential is in the predefined set of loads which is a part of distribution grid and may also cross TSO borders	
Cross border HVDC with preventive & curative volumes	Sharing the upwards and downwards potential for an HVDC between two control areas within a CCR, assuming that both TSOs may deliver their own view on the available volumes and the RAO should take the most constraining input as final.	
Cross border HVDC with preventive and curative volumes using bandwidth attribute	Sharing the upwards and downwards potential for an HVDC between two control areas within a CCR, assuming that both TSOs may deliver their own view on the available volumes and the RAO should take the most constraining input as final.	
Preventive RA: HVDC setpoint change	Change the setpoint in base case, only one connecting TSO, for HVDC cables connecting a TSO that belongs to one CCR with a TSO which belongs to another CCR	For some HVDCs between two different synchronous zone this must be done via redispatch because this type of HVDC has associated prices while this attribute is not foreseen for HVDC category so far.
Curative RA: HVDC setpoint change	Change the setpoint after contingency, only one connecting TSO	

Preventive RA: HVDC mode switch	Switch from one mode to another one in base case: DC setpoint/AC mode/hybrid mode.	Relevant for HVDC on AC border only.
Curative RA: HVDC mode switch	Switch from one mode to another one after contingency	Relevant for HVDC on AC border only
Preventive RA: HVDC Hybrid mode	Changing the hybrid mode in base case (parameter k)	Relevant for HVDC on AC border only
Curative RA: HVDC Hybrid mode	Changing the hybrid mode after contingency (parameter k)	Relevant for HVDC on AC border only
Manually proposed Remedial Actions (via RA Schedule)		
Remedial Actions agreed in FAP (via RA Schedule)		
Cancelled earlier agreed Remedial Actions		
Suggestion of Alternative RAs for RAC (might be in RAC part)		
Decision about agreed/rejected RAs for RAC		

2211

2212 **7.1.8 List of SPS**

2213

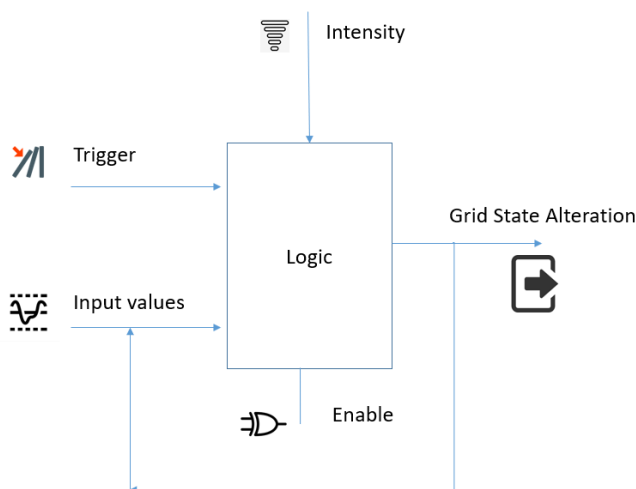

2214

**Figure 34 – SIPS overview**

2215

2216

2217 System Integrity Protection Schemes (SIPS), Special Protection Schemes (SPS) and Remedial  
 2218 Action Schemes (RAS) are often applied by TSOs to utilize the transmission capacity beyond  
 2219 conventional N-1 considerations. In many cases SIPS and SPS are used interchangeably, but  
 2220 in general SPS are considered part of SIPS.

2221 This is done while still maintaining reliability of supply, for example by relieving overloaded lines  
 2222 through immediate disconnection of generator units when lines are disconnected by their  
 2223 protective relay equipment. Other schemes are also in use, such as emergency power on HVDC  
 2224 links, load shedding and network splitting. Without modelling SIPS or RAS unrealistic  
 2225 congestion/overload will be reported by the power flow simulation tools.

2226 As shown in Figure 34, a SIPS is based on a logic which has inputs signals and related triggers  
2227 to start the logic. Depending on the logic conditions and the intensity of the event, if the logic  
2228 is enabled, the output of the SIPS will result in a grid state alteration.

2229 In the NC profiles the structural data for SPS remedial action is defined using Remedial Action  
2230 profile dataset. The Gate is defining the input logic and then Stage the output that is linked to  
2231 a GridStateAlterationCollection allowing multiple grid state alterations to be part of a Stage, i.e.  
2232 change to that will be applied after the gate trigger conditions are met.

2233 The following are some examples of the objectives of system-wide protection/control schemes:

- 2234 • Overload mitigation
- 2235 • System separation for transient stability
- 2236 • Load and generation shedding/rejection
- 2237 • Under and over voltage load shedding
- 2238 • Under and over frequency generation/load shedding
- 2239 • Detection/shutdown of islanded network
- 2240 • Over frequency tripping of unloaded generators
- 2241 • Improvement of power transmission to increase total transfer capability
- 2242 • Improvement of system stability under the large deployment of renewable energy  
2243 resources
- 2244 • Maximize the capability of apparatus (the thermal limit of apparatus).

2245 Any values described in SSH, SIS and SSI datasets can be input values for Grid State Alteration  
2246 value.

#### 2247 **7.1.8.1 SIPS Monitoring of a line and actions on topology and HVDC**

2248 In the SIPS example shown in Figure 35, a pre-fault flow values on a line and a trip of the same  
2249 line are used as input trigger conditions. On the grid state alteration output side, flow changes  
2250 on a HVDC as well as topology changes on filters are shown.

2251 In cases where a GridStateAlteration is used to modify a setpoint and this value is not subject  
2252 to optimisation, the following approach is used (note that this is considered as a short term  
2253 approach; more elaborated solution will be proposed in the next versions of this document):

- 2254 • StaticPropertyRange is defined for the given GridStateAlteration
- 2255 • RangeConstraint.direction is defined as RelativeDirectionKind.none
- 2256 • RangeConstraint.normalValue is considered as the target value / setpoint which is  
2257 fixed
- 2258 • The StaticPropertyRange shall not get RangeConstraint.value as part of other  
2259 profiles (e.g. SSI dataset) that would supersede .normalValue defined in the RA  
2260 dataset.

2261 The next versions of the document will elaborate more on this example.

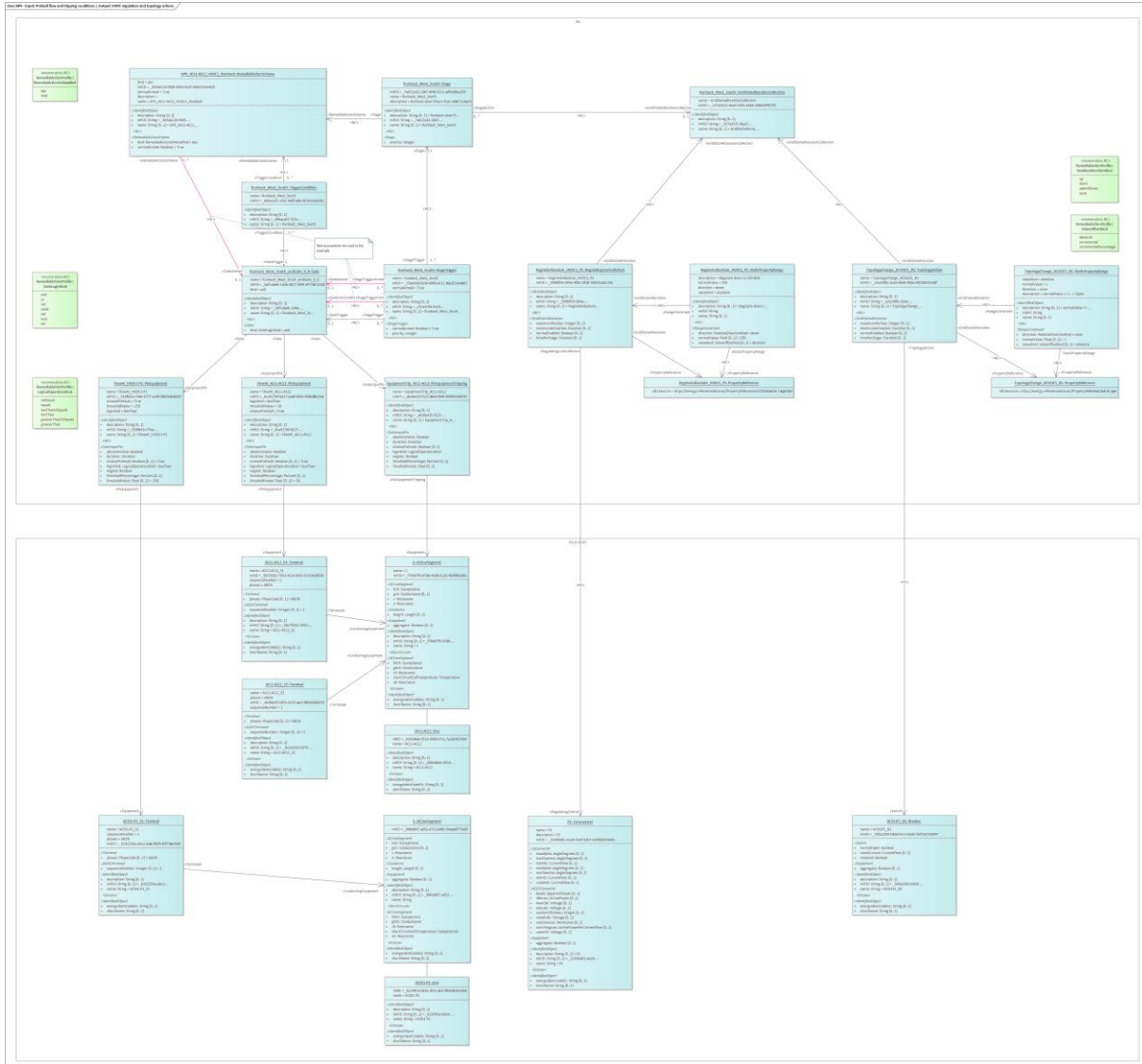

2262



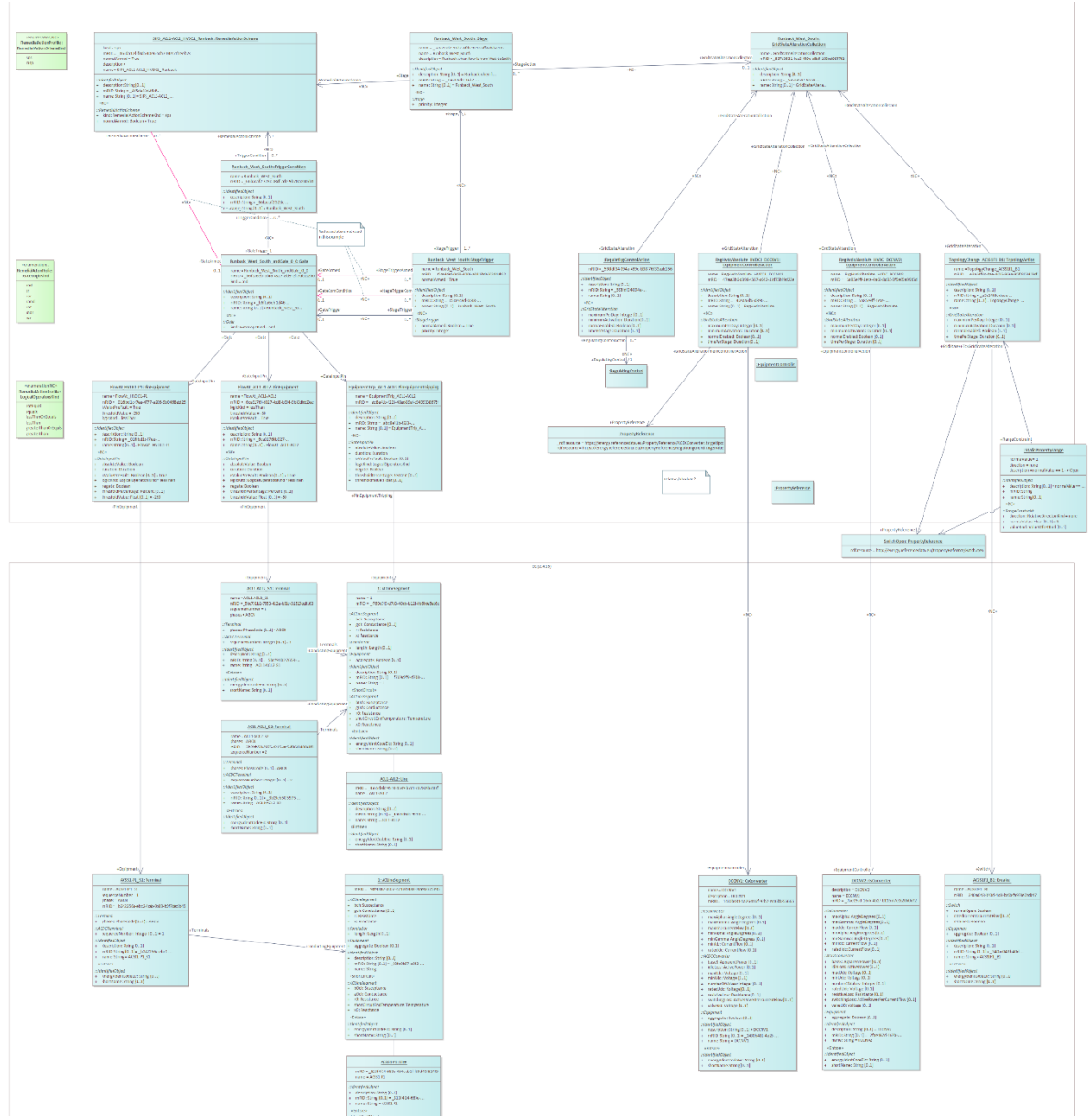

Figure 35 – SIPS Monitoring of a Line and Actions on Topology and HVDC

2263

2264

2265

7.1.8.2 Expected Use Cases

The following expects use cases are not explained in full detail. The next versions of the document could include more details.

2269

Table 8 – Expected Use Cases Related to SPS Remedial Action.

2270

Name	Description	Comment
Decrease/ increase of production curative without prices	Decrease of production on one/several units after a specific contingency in case of overload/from a predefined flow on one or several XNEs (with a	

	specified activation time and activation gradient)	
Automatic tap change position if the PATL is reached (PST)		
Automatic opening of a breaker, depending on criteria (example: PATL reached)		

2271 **7.1.9 List of System Constraints**

2272 There are different types of system constraints. Defining stability limits, voltage angle limits as  
2273 well as infeed limits defined on a power transfer corridor. These limits can be linked with the  
2274 assessed elements so that they can be scanned or secured.

2275 **7.1.9.1 Voltage Angle Limit**

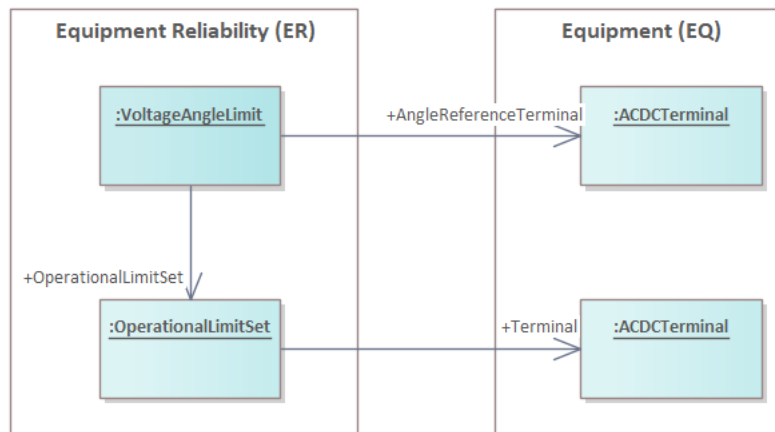

2276

2277 **Figure 36 – Voltage Angle Limit**

2278 The corresponding Equipment Reliability dataset snippet is as follows:

```

2279 <nc:VoltageAngleLimit rdf:ID=" c06b2f38-c6c6-4fec-8ddb-234eebaea8ec">
2280 <cim:IdentifiedObject.mRID>c06b2f38-c6c6-4fec-8ddb-234eebaea8ec</cim:IdentifiedObject.mRID>
2281 <cim:IdentifiedObject.name>VoltageAngleLimit1</cim:IdentifiedObject.name>
2282 <cim:IdentifiedObject.description>Limit for voltage angle at a specific
2283 terminal</cim:IdentifiedObject.description>
2284 <nc:VoltageAngleLimit.normalValue>10.0</nc:VoltageAngleLimit.normalValue>
2285 <nc:VoltageAngleLimit.AngleReferenceTerminal rdf:resource="#_5c206db8-ef8c-4e53-b2b9-38b52b194c5a"/>
2286 <cim:OperationalLimitSet rdf:resource="#_6fe5c43b-621c-88ac-1d90-22f075cdb50e"/>
2287 </nc:VoltageAngleLimit>
2288
    
```

2289 The corresponding Equipment dataset snippet is as follows:

```

2290 <cim:VoltageLimit rdf:ID="_c50c3855-28e9-b2c8-5d9d-199a5dbff8f3">
2291 <cim:IdentifiedObject.mRID>c50c3855-28e9-b2c8-5d9d-199a5dbff8f3</cim:IdentifiedObject.mRID>
2292 <cim:IdentifiedObject.name>high limit for BE-Busbar_1</cim:IdentifiedObject.name>
2293 <cim:OperationalLimitSet rdf:resource="#_6fe5c43b-621c-88ac-1d90-22f075cdb50e" />
2294 <cim:OperationalLimitType rdf:resource="#_82639e97-ec8d-59c3-3af6-0fcc05fa3eb4" />
2295 <cim:VoltageLimit.normalValue>421.8</cim:VoltageLimit.normalValue>
2296 </cim:VoltageLimit>
2297 <cim:OperationalLimitSet rdf:ID="_6fe5c43b-621c-88ac-1d90-22f075cdb50e">
2298 <cim:IdentifiedObject.mRID>6fe5c43b-621c-88ac-1d90-22f075cdb50e</cim:IdentifiedObject.mRID>
2299 <cim:IdentifiedObject.name>Voltage limits for BE-Busbar_1</cim:IdentifiedObject.name>
2300 <cim:OperationalLimitSet.Terminal rdf:resource="#_fa9e0f4d-8a2f-45e1-9e36-3611600d1c94" />
2301 </cim:OperationalLimitSet>
2302 <cim:Terminal rdf:ID="_fa9e0f4d-8a2f-45e1-9e36-3611600d1c94">
2303 <cim:ACDCTerminal.sequenceNumber>1</cim:ACDCTerminal.sequenceNumber>
2304 <cim:IdentifiedObject.mRID>fa9e0f4d-8a2f-45e1-9e36-3611600d1c94</cim:IdentifiedObject.mRID>
2305 <cim:IdentifiedObject.name>BE-Busbar_1_Busbar_Section</cim:IdentifiedObject.name>
2306 <cim:Terminal.ConnectingEquipment rdf:resource="#_64901aec-5a8a-4bcb-8ca7-a3ddbfc0e6c" />
2307 <cim:Terminal.ConnectivityNode rdf:resource="#_4836f99b-c6e9-4ee8-a956-b1e3da882d46" />
2308 </cim:Terminal>
2309
    
```

2310 **7.1.9.2 Power Transfer Corridor**

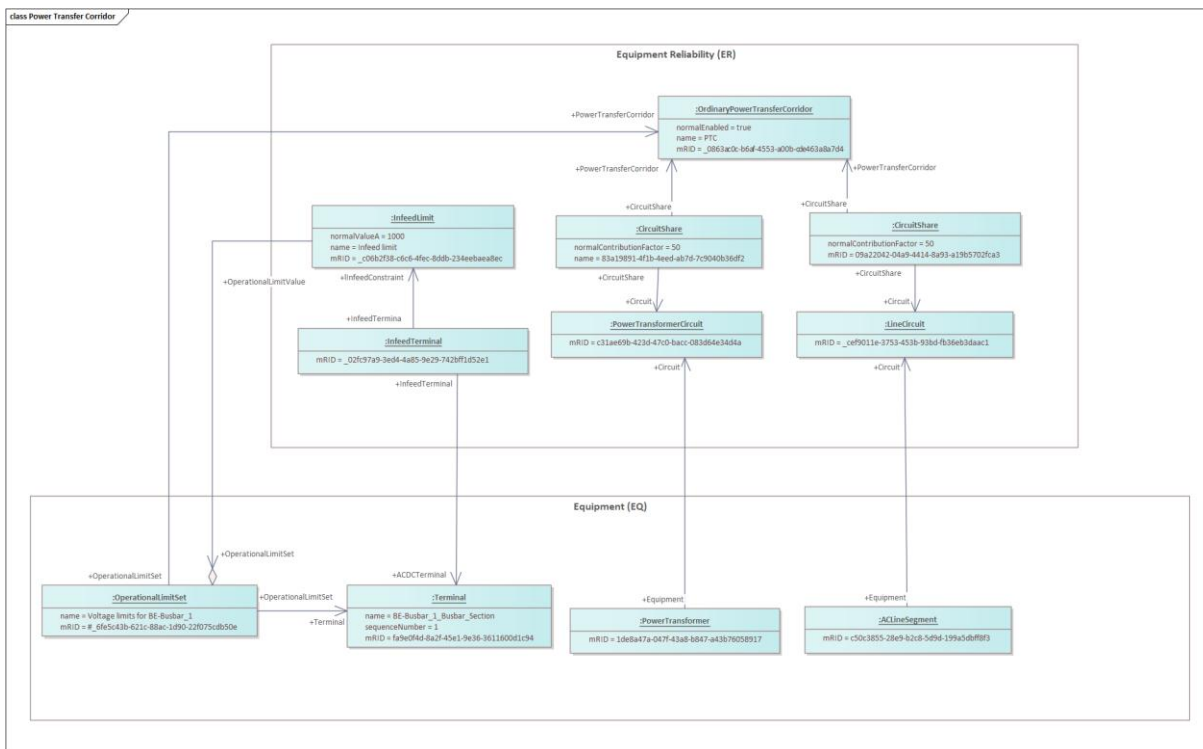

**Figure 37 – Power Transfer Corridor**

2311  
2312  
2313 Power transfer corridor is defined by PowerTransferCorridor class in the Equipment Reliability  
2314 dataset. It can be exceptional or ordinary type. In the example the ordinary power transfer  
2315 corridor is illustrated.

2316 A power transfer corridor can be composed by different circuits that have their share in the  
2317 corridor. Circuits can be lines, transformers or DC circuits. However, each circuit can have  
2318 different equipment object included in it.

2319 The example illustrates a power transfer corridor that have a LineCircuit, a  
2320 PowerTransformerCircuit, InfeedLimit.

2321 The corresponding Equipment Reliability dataset snippet is as follows:

```

2322 <nc:InfeedLimit rdf:ID="c06b2f38-c6c6-4fec-8ddb-234eebaea8ec">
2323 <cim:IdentifiedObject.mRID>c06b2f38-c6c6-4fec-8ddb-234eebaea8ec</cim:IdentifiedObject.mRID>
2324 <cim:IdentifiedObject.name>Infeed limit</cim:IdentifiedObject.name>
2325 <nc:InfeedLimit.normalValueA>1000.0</nc:InfeedLimit.normalValueA>
2326 <cim:OperationalLimitSet rdf:resource="#_6fe5c43b-621c-88ac-1d90-22f075cdb50e"/>
2327 </nc:InfeedLimit>
2328
2329 <nc:InfeedTerminal rdf:ID="02fc97a9-3ed4-4a85-9e29-742bff1d52e1">
2330 <nc:InfeedTerminal.mRID>02fc97a9-3ed4-4a85-9e29-742bff1d52e1</nc:InfeedTerminal.mRID>
2331 <nc:InfeedTerminal.InfeedConstraint rdf:resource="#_c06b2f38-c6c6-4fec-8ddb-234eebaea8ec"/>
2332 <nc:InfeedTerminal.ACDCTerminal rdf:resource="#_fa9e0f4d-8a2f-45e1-9e36-3611600d1c94"/>
2333 </nc:InfeedTerminal>
2334
2335 <nc:LineCircuit rdf:ID="cef9011e-3753-453b-93bd-fb36eb3daac1">
2336 <nc:InfeedTerminal.mRID>cef9011e-3753-453b-93bd-fb36eb3daac1</nc:InfeedTerminal.mRID>
2337 </nc:LineCircuit>
2338
2339 <nc:PowerTransformerCircuit rdf:ID="c31ae69b-423d-47c0-bacc-083d64e34d4a">
2340 <nc:InfeedTerminal.mRID>c31ae69b-423d-47c0-bacc-083d64e34d4a</nc:InfeedTerminal.mRID>
2341 </nc:PowerTransformerCircuit>
2342
2343 <cim:Equipment rdf:about="_c50c3855-28e9-b2c8-5d9d-199a5dbff8f3">
2344 <nc:Equipment.Circuit rdf:resource="#_cef9011e-3753-453b-93bd-fb36eb3daac1"/>
2345 </cim:Equipment>
2346
2347 <cim:Equipment rdf:about="_1de8a47a-047f-43a8-b847-a43b76058917">
2348 <nc:Equipment.Circuit rdf:resource="#_c31ae69b-423d-47c0-bacc-083d64e34d4a"/>
2349 </cim:Equipment>
    
```

```

2350 <nc:OrdinaryPowerTransferCorridor rdf:ID=" 0863ac0c-b6af-4553-a00b-cde463a8a7d4">
2351 <cim:IdentifiedObject.mRID>0863ac0c-b6af-4553-a00b-cde463a8a7d4</cim:IdentifiedObject.mRID>
2352 <cim:IdentifiedObject.name>PTC</cim:IdentifiedObject.name>
2353 <nc:PowerTransferCorridor.normalEnabled>true</nc:PowerTransferCorridor.normalEnabled>
2354 </nc:OrdinaryPowerTransferCorridor>
2355
2356 <cim:OperationalLimitSet rdf:about=" 6fe5c43b-621c-88ac-1d90-22f075cdb50e">
2357 <nc:OperationalLimitSet.PowerTransferCorridor rdf:resource="#_0863ac0c-b6af-4553-a00b-cde463a8a7d4"/>
2358 </cim:OperationalLimitSet>
2359
2360 <cim:CircuitShare rdf:about="_09a22042-04a9-4414-8a93-a19b5702fca3">
2361 <cim:IdentifiedObject.mRID>09a22042-04a9-4414-8a93-a19b5702fca3</cim:IdentifiedObject.mRID>
2362 <nc:CircuitShare.Circuit rdf:resource="#_cef9011e-3753-453b-93bd-fb36eb3daac1"/>
2363 <nc:CircuitShare.PowerTransferCorridor rdf:resource="#_0863ac0c-b6af-4553-a00b-cde463a8a7d4"/>
2364 <nc:CircuitShare.normalContributionFactor>50</nc:CircuitShare.normalContributionFactor>
2365 </nc:CircuitShare>
2366 <cim:CircuitShare rdf:about=" 83a19891-4f1b-4eed-ab7d-7c9040b36df2">
2367 <cim:IdentifiedObject.mRID>83a19891-4f1b-4eed-ab7d-7c9040b36df2</cim:IdentifiedObject.mRID>
2368 <nc:CircuitShare.Circuit rdf:resource="#_c31ae69b-423d-47c0-bacc-083d64e34d4a "/>
2369 <nc:CircuitShare.PowerTransferCorridor rdf:resource="#_0863ac0c-b6af-4553-a00b-cde463a8a7d4"/>
2370 <nc:CircuitShare.normalContributionFactor>50</nc:CircuitShare.normalContributionFactor>
2371 </nc:CircuitShare>
2372 </nc:CircuitShare>
2373
2374

```

The corresponding Equipment dataset snippet is as follows:

```

2376 <cim:ACLineSegment rdf:ID=" c50c3855-28e9-b2c8-5d9d-199a5dbff8f3">
2377 <cim:IdentifiedObject.mRID>c50c3855-28e9-b2c8-5d9d-199a5dbff8f3</cim:IdentifiedObject.mRID>
2378 ...
2379 </cim:ACLineSegment>
2380 <cim:PowerTransformer rdf:ID=" _1de8a47a-047f-43a8-b847-a43b76058917">
2381 <cim:IdentifiedObject.mRID>1de8a47a-047f-43a8-b847-a43b76058917</cim:IdentifiedObject.mRID>
2382 ...
2383 </cim:PowerTransformer>
2384
2385 <cim:OperationalLimitSet rdf:ID=" 6fe5c43b-621c-88ac-1d90-22f075cdb50e">
2386 <cim:IdentifiedObject.mRID>6fe5c43b-621c-88ac-1d90-22f075cdb50e</cim:IdentifiedObject.mRID>
2387 <cim:IdentifiedObject.name>Voltage limits for BE-Busbar_1</cim:IdentifiedObject.name>
2388 <cim:OperationalLimitSet.Terminal rdf:resource="#_fa9e0f4d-8a2f-45e1-9e36-3611600d1c94" />
2389 </cim:OperationalLimitSet>
2390 <cim:Terminal rdf:ID=" fa9e0f4d-8a2f-45e1-9e36-3611600d1c94">
2391 <cim:ACDCTerminal.sequenceNumber>1</cim:ACDCTerminal.sequenceNumber>
2392 <cim:IdentifiedObject.mRID>fa9e0f4d-8a2f-45e1-9e36-3611600d1c94</cim:IdentifiedObject.mRID>
2393 <cim:IdentifiedObject.name>BE-Busbar_1_Busbar_Section</cim:IdentifiedObject.name>
2394 <cim:Terminal.ConductingEquipment rdf:resource="#_64901aec-5a8a-4bcb-8ca7-a3ddbfc0e6c" />
2395 <cim:Terminal.ConnectivityNode rdf:resource="#_4836f99b-c6e9-4ee8-a956-b1e3da882d46" />
2396 </cim:Terminal>
2397

```

In order to cover wider range of use cases the power transfer corridor can be composed by using the association Circuit.IdentifyingTerminal. Therefore, a Circuit shall have an association with either a Terminal or an Equipment. **Error! Reference source not found.** illustrates this approach.

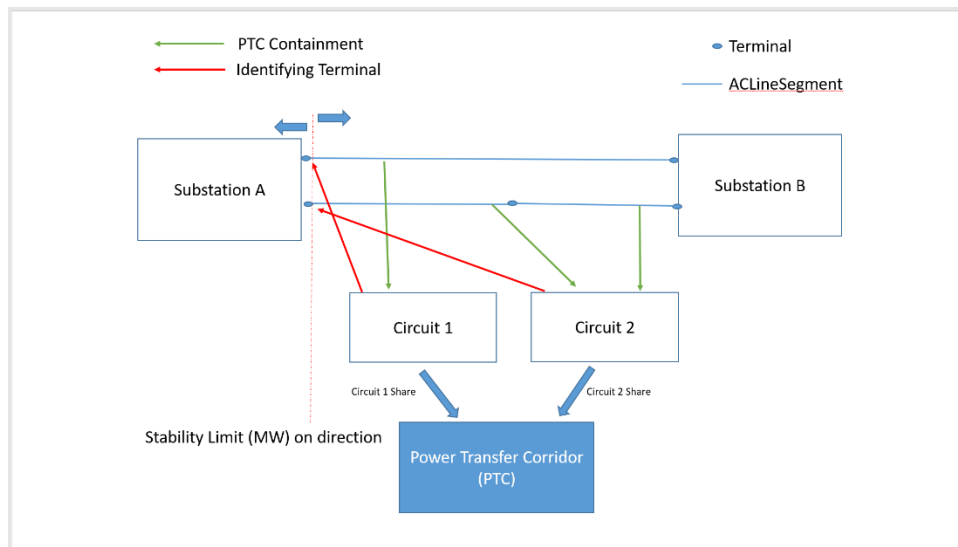

Figure 38 – Power Transfer Corridor – using Terminals

2405 **7.1.10 Define scope of the analysis**

2406 Monitoring area profile defines possibility to exchange the definition of the following types of  
2407 areas: monitoring area, observability area, sensitivity area, contingency area. Some of the use  
2408 cases when usage of area definition is necessary are:

- 2409 - In cases where it is required to identify the are based on influence factors
- 2410 - In cases where the receiving system does not select all data submitted but needs to
- 2411 analyse part of the area. For instance, region A analysis needs to include part of region
- 2412 B.

2413 Are definition uses the class AreaBorderTerminal to define the borders of the area. The  
2414 following snippet illustrates definition of a monitoring area with two terminals. Eventually it is  
2415 expected that there will be many terminals defined as the border needs to circle the area.

```

2416 <nc:MonitoringArea rdf:ID="_adf0cf12-8f61-45af-b073-d73dd30e078d">
2417 <cim:IdentifiedObject.mRID>adf0cf12-8f61-45af-b073-d73dd30e078d</cim:IdentifiedObject.mRID>
2418 <cim:IdentifiedObject.name>My observability area</cim:IdentifiedObject.name>
2419 <nc:MonitoringArea.SystemOperator rdf:resource="#_b1a6650b-bf47-469b-81f5-0319c265354b"/>
2420 <nc:MonitoringArea.SynchronousArea rdf:resource="#_104f34a9-4b02-41a1-b3fb-2e3802e166b8"/>
2421 </nc:MonitoringArea >
2422
2423 <nc:AreaBorderTerminal rdf:ID="_d7777b3f-4acb-452a-acca-5b100b299ba8">
2424 <nc:AreaBorderTerminal.mRID>d7777b3f-4acb-452a-acca-5b100b299ba8</ nc:AreaBorderTerminal.mRID >
2425 <nc:AreaBorderTerminal.MonitoringArea rdf:resource="#_adf0cf12-8f61-45af-b073-d73dd30e078d"/>
2426 <nc:AreaBorderTerminal.Terminal rdf:resource="#_e504d183-64fb-4e44-9598-d19760660919"/>
2427 </nc:ObservabilityArea >
2428
2429 <nc:AreaBorderTerminal rdf:ID="_418469cd-5e95-4320-bb1f-28e5dc0ea15f">
2430 <nc:AreaBorderTerminal.mRID>418469cd-5e95-4320-bb1f-28e5dc0ea15f</ nc:AreaBorderTerminal.mRID >
2431 <nc:AreaBorderTerminal.MonitoringArea rdf:resource="#_adf0cf12-8f61-45af-b073-d73dd30e078d"/>
2432 <nc:AreaBorderTerminal.Terminal rdf:resource="#_c677bd82-40f3-40ac-a11b-01832631ced9"/>
2433 </nc:ObservabilityArea >
    
```

2434

2435 **7.2 Regional Security Assessment**

2436 **7.2.1 Description**

2437 The Regional Security Assessment (RSA) is performed by the Security Assessment  
2438 Coordinator. For information, the RSA is part of CROSA and is performed in intraday. The RSA  
2439 subprocess is illustrated in Figure 39.

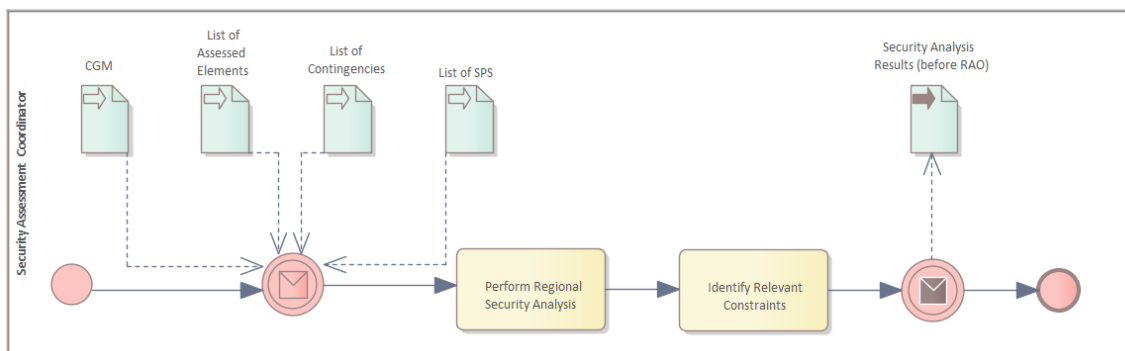

2440

2441 **Figure 39 – Regional Security Assessment.**

2442

2443 **7.2.2 Inputs and Outputs**

2444 The list of Inputs and Outputs that are part of the subprocess is defined in Table 9.

2445

2446 **Table 9 – Inputs and Outputs for Regional Security Assessment**

Inputs	Outputs
Common Grid Model for the studied timeframe	Security Analysis Results (before RAO)
List of Assessed Elements	
List of Contingencies	
List of SPS (optional)	
The intensity (RAS) for agreed curative RA	

2447

2448 **7.2.3 Conformity Requirements**

2449 To be able to support regional security assessment the Application shall conform to the

2450 following Application functions:

- 2451 • Security analysis.

2452 **7.3 Remedial Action Optimization**

2453 **7.3.1 Description**

2454 The Remedial Action Optimization (RAO) is performed by the Remedial Action Optimization

2455 Operator. The RAO subprocess is illustrated in Figure 40.

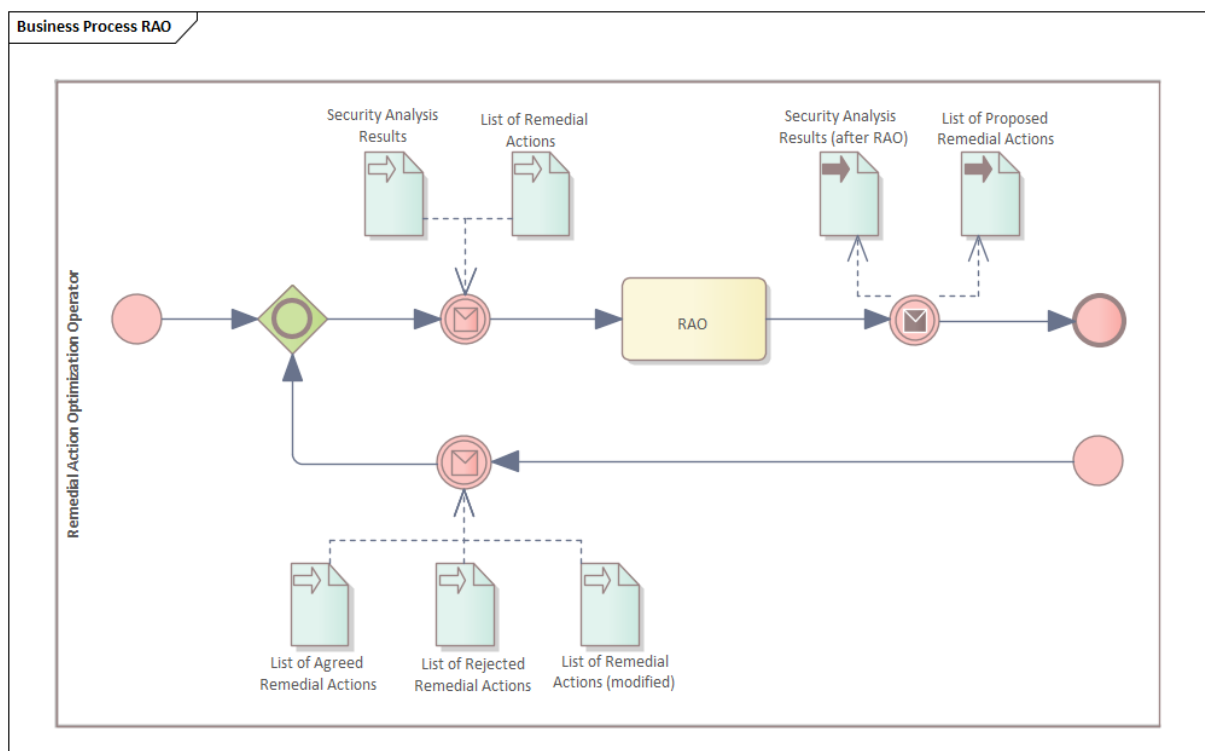

2456

2457 **Figure 40 – Remedial Action Optimization.**

2458

2459 **7.3.2 Inputs and Outputs**

2460 **Table 10 – Inputs and Outputs for Remedial Action Optimization**

Inputs	Outputs
List of Available Remedial Actions	Security Analysis Results (after RAO, thus including proposed Remedial Actions)

Security Analysis Result (incl. Identified Constraints, before RAO, thus without proposed Remedial Actions)	List of Proposed Remedial Actions including sensitivity of Remedial Actions, at least on violations and cost of proposed Remedial Actions (per RA and in total)
Predefined rules for optimization – the exchange and the process for this is still to be defined	

2461

2462 **7.3.3 Conformity Requirements**

2463 To be able to support remedial action optimization the Application shall conform to the following  
2464 Application functions:

- 2465 • Remedial action optimization.

2466 **7.3.4 Proposed Remedial Action Schedule**

2467 In general, the RAS profile can be used as an input if it is needed to inform that a remedial  
2468 action is already used (before optimisation). SSI and SIS datasets include information if the  
2469 remedial action is available to be used by the optimiser.

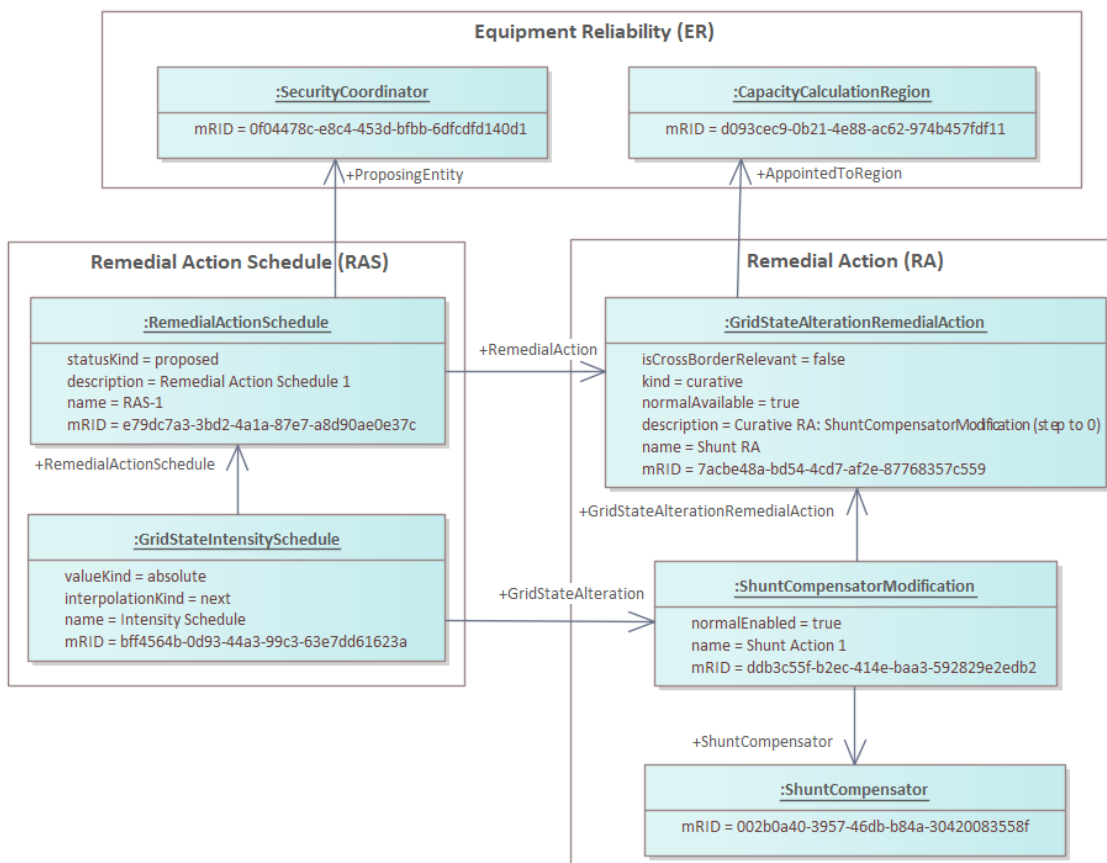

2470

2471 **Figure 41 – Proposed Remedial Action Schedule – Grid Intensity**

2472 The corresponding Remedial Action Schedule dataset snippet is as follows:

```

2473 <nc:GridStateIntensitySchedule rdf:ID="bff4564b-0d93-44a3-99c3-63e7dd61623a">
2474 <cim:IdentifiedObject.name>intensity schedule</cim:IdentifiedObject.name>
2475 <cim:IdentifiedObject.mRID>bff4564b-0d93-44a3-99c3-63e7dd61623a</cim:IdentifiedObject.mRID>
2476 <nc:BaseTimeSeries.interpolationKind rdf:resource="https://cim4.eu/ns/nc#TimeSeriesInterpolationKind.next"/>
2477 <nc:GenericValueSchedule.RemedialActionSchedule rdf:resource="#_e79dc7a3-3bd2-4a1a-87e7-a8d90ae0e37c"/>
    
```

```

2478 <nc:GridStateIntensitySchedule.valueKind rdf:resource="https://cim4.eu/ns/nc#ValueOffsetKind.absolute"/>
2479 <nc:GridStateIntensitySchedule.GridStateAlteration rdf:resource="#_ddb3c55f-b2ec-414e-baa3-592829e2edb2"/>
2480 </nc:GridStateIntensitySchedule>
2481 <nc:RemedialActionSchedule rdf:ID="_e79dc7a3-3bd2-4a1a-87e7-a8d90ae0e37c">
2482 <cim:IdentifiedObject.name>RAS-1</cim:IdentifiedObject.name>
2483 <cim:IdentifiedObject.mRID>e79dc7a3-3bd2-4a1a-87e7-a8d90ae0e37c</cim:IdentifiedObject.mRID>
2484 <cim:IdentifiedObject.description>Remedial Action Schedule 1</cim:IdentifiedObject.description>
2485 <nc:RemedialActionSchedule.ProposingEntity rdf:resource="#_0f04478c-e8c4-453d-bfbb-6dfcdfd140d1"/>
2486 <nc:RemedialActionSchedule.RemedialAction rdf:resource="#_7acbe48a-bd54-4cd7-af2e-87768357c559"/>
2487 <nc:RemedialActionSchedule.statusKind
2488 rdf:resource="https://cim4.eu/ns/nc#RemedialActionScheduleStatusKind.proposed"/>
2489 </nc:RemedialActionSchedule>
2490
2491 <nc:GenericValueTimePoint rdf:ID="_7dc3a232-66b2-4258-9f4a-1652bdddea8a">
2492 <nc:GenericValueTimePoint.GenericValueSchedule rdf:resource="#_bff4564b-0d93-44a3-99c3-63e7dd61623a"/>
2493 <nc:GenericValueTimePoint.value>0.0</nc:GenericValueTimePoint.value>
2494 <nc:GenericValueTimePoint.atTime>2022-06-16T04:30:00Z</nc:GenericValueTimePoint.atTime>
2495 </nc:GenericValueTimePoint>

```

2496 The Remedial Action dataset is as follows:

```

2497 <nc:ShuntCompensatorModification rdf:ID="_ddb3c55f-b2ec-414e-baa3-592829e2edb2">
2498 <cim:IdentifiedObject.mRID>ddb3c55f-b2ec-414e-baa3-592829e2edb2</cim:IdentifiedObject.mRID>
2499 <cim:IdentifiedObject.name>Shunt action 1</cim:IdentifiedObject.name>
2500 <nc:GridStateAlteration.PropertyReference
2501 rdf:resource="https://energy.referencedata.eu/PropertyReference/ShuntCompensator.sections"/>
2502 <nc:GridStateAlteration.GridStateAlterationRemedialAction rdf:resource="#_7acbe48a-bd54-4cd7-af2e-87768357c559"/>
2503 <nc:GridStateAlteration.normalEnabled>true</nc:GridStateAlteration.normalEnabled>
2504 <nc:ShuntCompensatorModification.ShuntCompensator rdf:resource="#_002b0a40-3957-46db-b84a-30420083558f"/>
2505 </nc:ShuntCompensatorModification>
2506 <nc:GridStateAlterationRemedialAction rdf:ID="_7acbe48a-bd54-4cd7-af2e-87768357c559">
2507 <cim:IdentifiedObject.mRID>7acbe48a-bd54-4cd7-af2e-87768357c559</cim:IdentifiedObject.mRID>
2508 <cim:IdentifiedObject.name>shunt RA</cim:IdentifiedObject.name>
2509 <cim:IdentifiedObject.description>Curative RA: ShuntCompensatorModification (step to 0). Shunt compensator ID:
2510 _002b0a40-3957-46db-b84a-30420083558f</cim:IdentifiedObject.description>
2511 <nc:RemedialAction.normalAvailable>true</nc:RemedialAction.normalAvailable>
2512 <nc:RemedialAction.kind rdf:resource="https://cim4.eu/ns/nc#RemedialActionKind.curative"/>
2513 <nc:RemedialAction.isCrossBorderRelevant>true</nc:RemedialAction.isCrossBorderRelevant>
2514 <nc:RemedialAction.AppointedToRegion rdf:resource="#_d093cec9-0b21-4e88-ac62-974b457fdf11"/>
2515 </nc:GridStateAlterationRemedialAction>

```

## 2516 7.4 Remedial Action Coordination

### 2517 7.4.1 Description

2518 The Remedial Action Coordination (RAC) is performed by the Remedial Action Coordinator. The  
2519 RAC subprocess is illustrated in Figure 42.



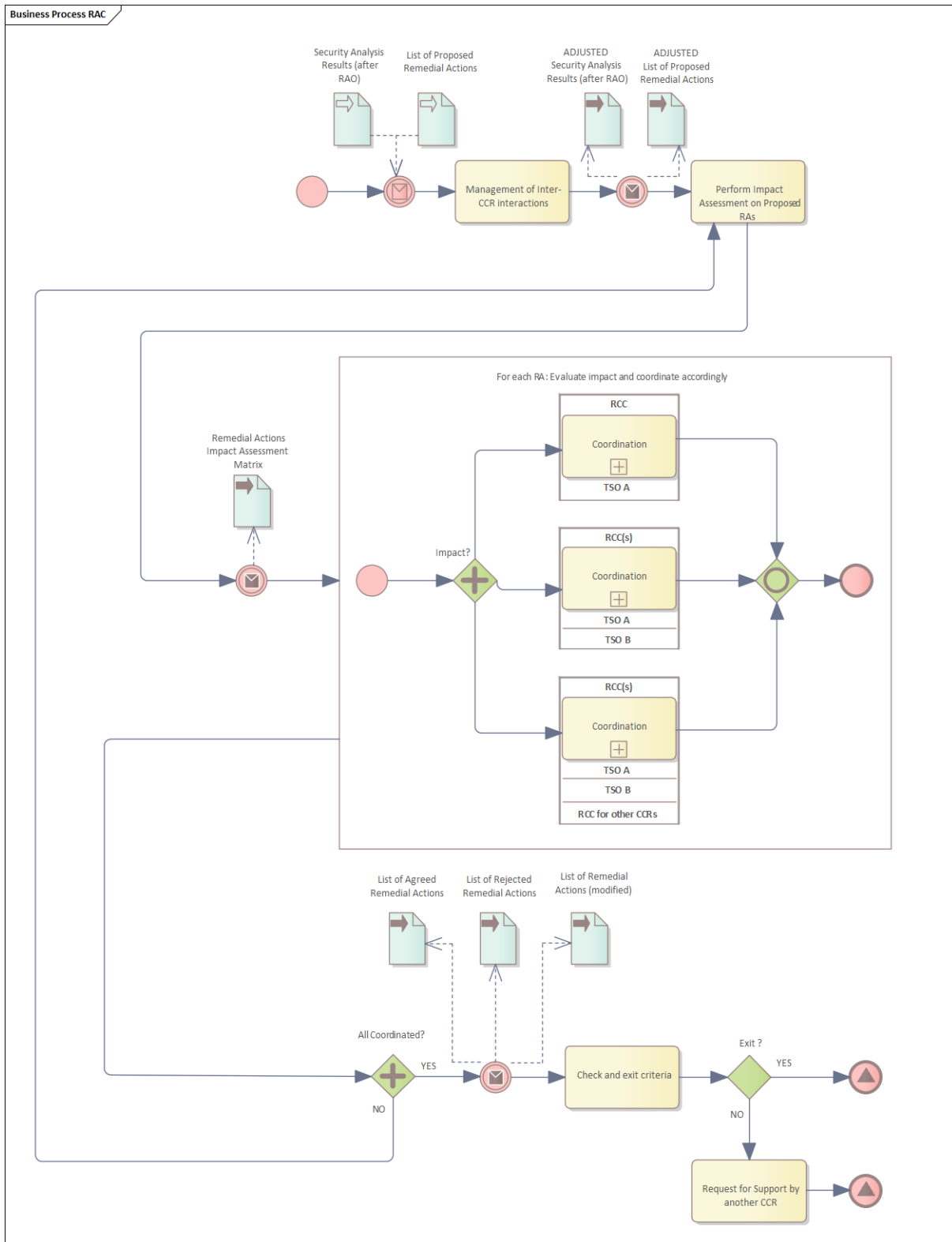

2520

2521

2522

**Figure 42 – Remedial Action Coordination**

2523 **7.4.2 Inputs and Outputs**2524 **Table 11 – Inputs and Outputs for Remedial Action Coordination**

Inputs	Outputs
List of Proposed Remedial Actions including sensitivity of Remedial Actions on Identified Constraints and costs of proposed Remedial Actions (per Remedial Action and in total)	Remedial Action Impact Assessment Matrix (with indication of impacted TSOs per RA)
Security Analysis Results (after RAO)	List of Agreed Remedial Actions
	List of Rejected Remedial Actions

2525 **7.4.3 Conformity Requirements**

2526 To be able to support remedial action coordination the Application shall conform to the following  
2527 Application functions:

- 2528 • Coordination Confirmation.

2529 **7.4.4 Remedial Action Schedule – After Coordination**

2530 The following snippet from the Remedial Action Schedule dataset illustrates an acceptance of  
2531 a Remedial Action Schedule (corresponding to the proposed schedule above) upon the  
2532 completion of the coordination process:

```
2533 <nc:RemedialActionScheduleAcceptance rdf:ID="_ac45dd32-c3de-49d3-9664-689b5a762fd5">
2534 <cim:IdentifiedObject.mRID>ac45dd32-c3de-49d3-9664-689b5a762fd5</cim:IdentifiedObject.mRID>
2535 <nc:RemedialActionScheduleAcceptance.kind rdf:resource =
2536 "https://cim4.eu/ns/nc#RemedialActionScheduleAcceptanceKind.accepted"/>
2537 <nc:RemedialActionScheduleAcceptance.RemedialActionSchedule rdf:resource="#_e79dc7a3-3bd2-4a1a-87e7-
2538 a8d90ae0e37c"/>
2539 <nc:RemedialActionScheduleAcceptance.SystemOperator rdf:resource="#_31cf0436-1ede-452a-8b59-2a65bfcd9006"/>
2540 </nc:RemedialActionScheduleAcceptance>
```

2541 The following snippet from the Remedial Action Schedule and Impact Assessment Matrix  
2542 dataset illustrates the outcome of a rejection of a Remedial Action Schedule upon the  
2543 completion of the coordination process:

```
2544 <!-- Remedial Action Schedule Profile -->
2545
2546 <nc:RemedialActionSchedule rdf:ID="_e79dc7a3-3bd2-4a1a-87e7-a8d90ae0e7c">
2547 <cim:IdentifiedObject.name>RAS</cim:IdentifiedObject.name>
2548 <cim:IdentifiedObject.mRID>e79dc7a3-3bd2-4a1a-87e7-a8d90ae0e37c</cim:IdentifiedObject.mRID>
2549 <cim:IdentifiedObject.description>RAS</cim:IdentifiedObject.description>
2550 <nc:RemedialActionSchedule.ProposingEntity rdf:resource="https://energy.referencedata.eu/energy/EIC/10Y1001C--
2551 000"5L"/>
2552 <nc:RemedialActionSchedule.RemedialAction rdf:resource="#_7acbe48a-bd54-4cd7-af2e-87768357c59"/>
2553 <nc:RemedialActionSchedule.statusKind
2554 rdf:resource="https://cim4.eu/ns/nc#RemedialActionScheduleStatusKind.proposed"/>
2555 </nc:RemedialActionSchedule>
2556 --- Impact Assessment Matrix Profile ---
2557
2558 <nc:RemedialActionScheduleOutcomeValue rdf:ID="_9f16db8d-3c1f-4fe8-b22f-51e223c8994">
2559 <cim:IdentifiedObject.mRID>9f16db8d-3c1f-4fe8-b22f-51e223c8994</cim:IdentifiedObject.mRID>
2560 <nc:OutcomeValue.ImpactAssessmentMatrix rdf:resource="#_1555e1eb-ba6a-4171-bf0c-18d89fcf8b0"/>
2561 <nc:OutcomeValue.ImpactedSystemOperator rdf:resource="#_1682bb5a-0eca-4923-a898-f7b6c4aa82b"/>
2562 <nc:OutcomeValue.outcome rdf:resource="https://cim4.eu/ns/nc#OutcomeImpactAssessmentKind.false"/>
2563 <nc:RemedialActionScheduleOutcomeValue.RemedialActionSchedule rdf:resource="#_e79dc7a3-3bd2-4a1a-87e7-a8d90ae0e7c"/>
2564 </nc:RemedialActionScheduleOutcomeValue>
```

2566 **7.4.5 Remedial Action Schedule – Grouping**

2567 There are multiple use cases where the usage of grouping of remedial action schedules is  
2568 necessary. The following figures illustrate two possible scenarios of grouping. In the figures RA  
2569 is the RemedialAction, RAS – RemedialActionSchedule, RASG –  
2570 RemedialActionScheduleGroup, RASD - RemedialActionScheduleDependency

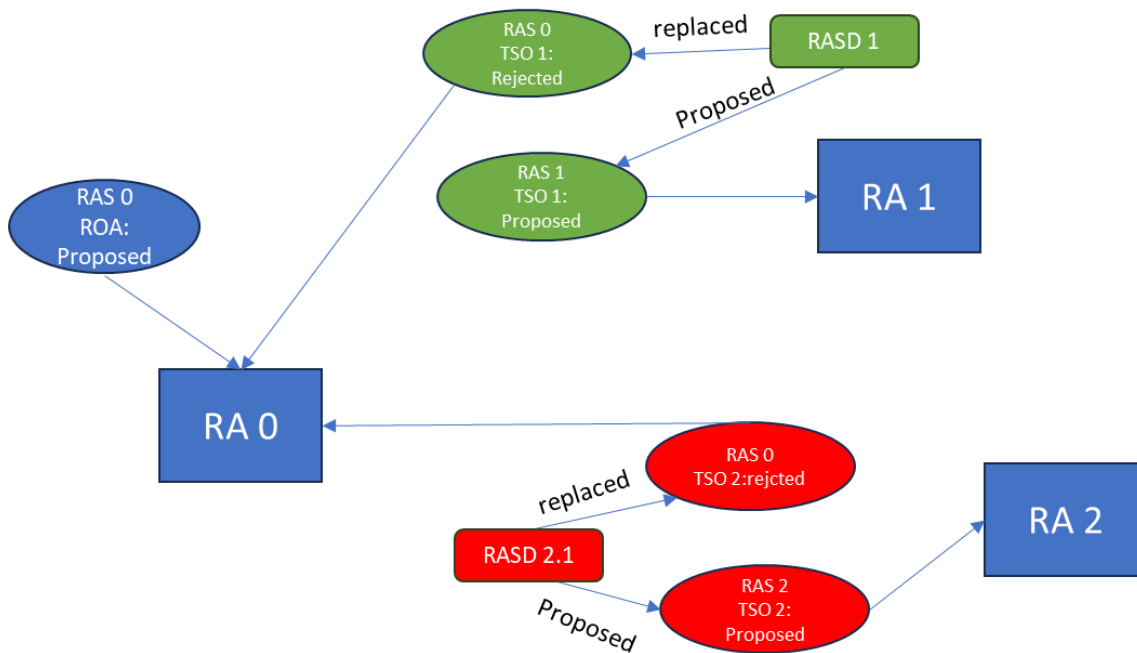

2571

2572

**Figure 43 – Remedial Action Schedule Relationship without using the Group**

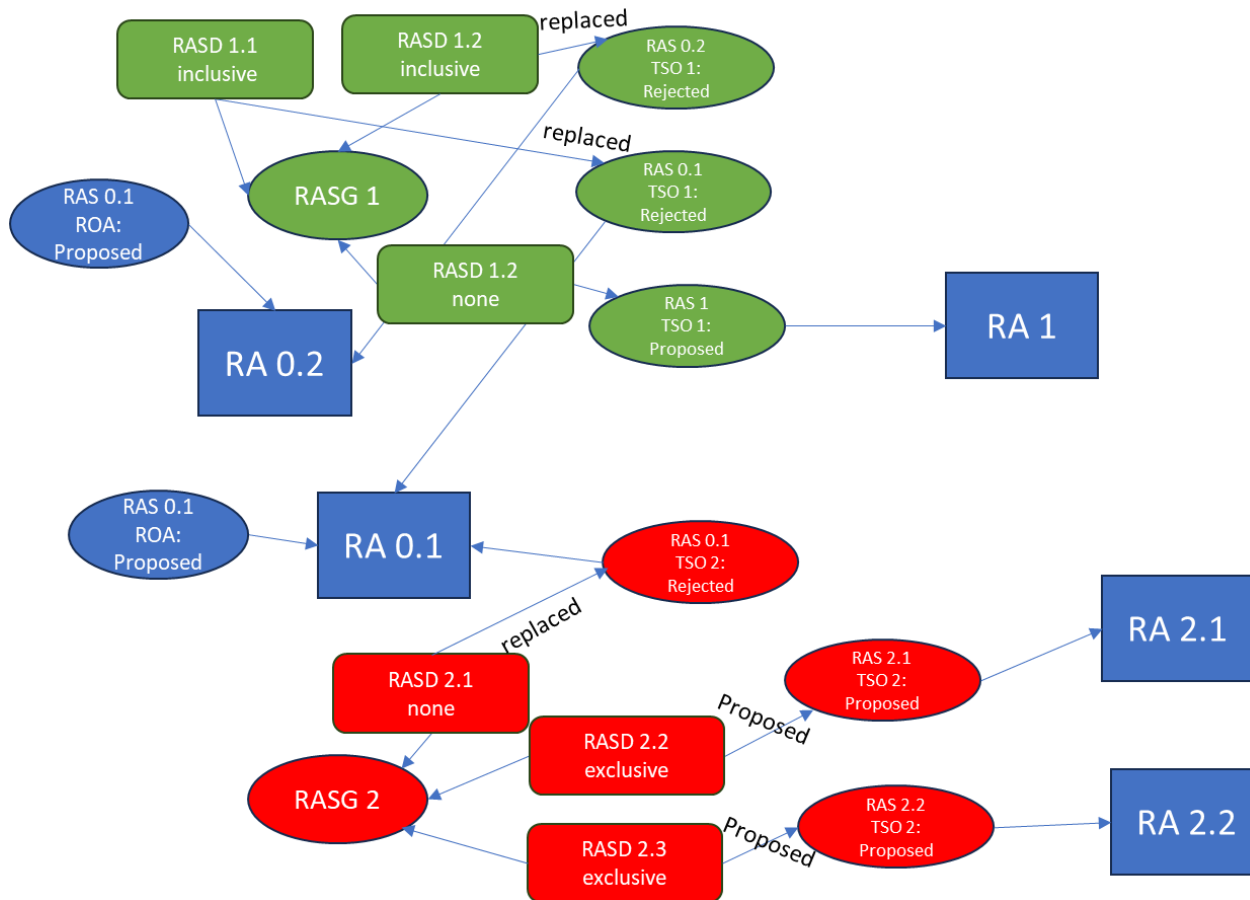

2573

2574

2575

2576

2577

**Figure 44 – Remedial Action Schedule Relationship within a Group**

These two options of grouping and expressing dependency allow full flexibility and ability to express which remedial action schedules were rejected and that are the proposed alternatives

2578 in a complex process where proposals can reject previous proposals and alternative remedial  
 2579 actions can be scheduled.  
 2580

2581 **7.5 Final Validation**

2582 **7.5.1 Description**

2583 The Final Validation session is performed by the Remedial Action Validator. The subprocess is  
 2584 illustrated in Figure 45.

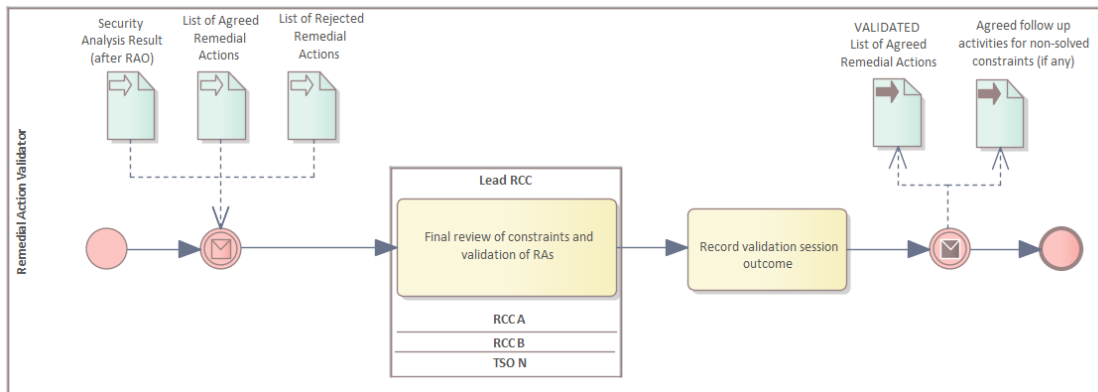

2585  
 2586 **Figure 45 – Final Validation session**  
 2587

2588 **7.5.2 Inputs and Outputs**

2589 **Table 12 – Inputs and Outputs for Final Remedial Action Validation**

Inputs	Outputs
Outcome of RA agreement process (agreed remedial actions and their schedule)	Validated and potentially updated Remedial Action Impact Assessment Matrix (with indication of impacted TSOs)
Security Analysis Results (after RAO)	Agreed follow-up activities for non- solved Identified Constraints, if any

2590  
 2591 The following snippets illustrate the Impact Assessment Matrix and the corresponding Remedial  
 2592 Action and Remedial Action Schedule.

2593 The Remedial Action dataset is as follows:

```

2594 <nc:TapPositionAction rdf:"D=" 587cb391-ed1°-4ald-876e-f90241add"e5">
2595 <cim:IdentifiedObject.mRID>587cb391-ed1°-4ald-876e-f90241addce5</cim:IdentifiedObject.mRID>
2596 <cim:IdentifiedObject.name>TapRA</cim:IdentifiedObject.name>
2597 <cim:IdentifiedObject.description>This is an example of tap position action</cim:IdentifiedObject.description>
2598 <nc:GridStateAlteration.PropertyReference
2599 rdf:resour"e="https://energy.referencedata.eu/PropertyReference/TapChanger.s"ep"/>
2600 <nc:GridStateAlteration.GridStateAlterationRemedialAction rdf:resour"e"="#_5898c268-9b32-4ab5-9cfc-
2601 64546135a"37"/>
2602 <nc:GridStateAlteration.normalEnabled>true</nc:GridStateAlteration.normalEnabled>
2603 <nc:TapPositionAction.TapChanger rdf:resour"e"="#_f6e8823f-d431-6fc7-37cf-b7a0d8003"dd"/>
2604 </nc:TapPositionAction>
2605
2606 <nc:GridStateAlterationRemedialAction rdf:"D=" 5898c268-9b32-4ab5-9cfc-64546135a"37">
2607 <cim:IdentifiedObject.mRID>5898c268-9b32-4ab5-9cfc-64546135a337</cim:IdentifiedObject.mRID>
2608 <cim:IdentifiedObject.name>RA1</cim:IdentifiedObject.name>
2609 <cim:IdentifiedObject.description>This is an example. Curative RA: TapPositionAction on PST (Tap position =
2610 6)</cim:IdentifiedObject.description>
2611 <nc:RemedialAction.normalAvailable>true</nc:RemedialAction.normalAvailable>
2612 <nc:RemedialAction.kind rdf:resour"e="https://cim4.eu/ns/nc#RemedialActionKind.curat"ve"/>
2613 <nc:RemedialAction.isCrossBorderRelevant>true</nc:RemedialAction.isCrossBorderRelevant>
2614 <nc:RemedialAction.AppointedToRegion rdf:resour"e"="#_7dabea20-7b2f-4f53-a4fd-8c075c9ed"8c"/>
2615 </nc:GridStateAlterationRemedialAction>
    
```

2616 The Remedial Action Schedule dataset is as follows:

```

2617 <nc:RemedialActionSchedule rdf:"D=" 264f9a19-ae29-4c95-b44c-6b7919ca0"6c">
2618 <cim:IdentifiedObject.name>RAS</cim:IdentifiedObject.name>
2619 <cim:IdentifiedObject.mRID>264f9a19-ae29-4c95-b44c-6b7919ca0f6c</cim:IdentifiedObject.mRID>
2620 <nc:RemedialActionSchedule.ProposingEntity rdf:resour"e"="https://energy.referencedata.eu/energy/EIC/10Y1001C-
2621 000"5L"/>
2622 <nc:RemedialActionSchedule.RemedialAction rdf:resource"#_587cb391-ed16-4a1d-876e-f90241adde5"/>
2623 <nc:RemedialActionSchedule.statusKind
2624 rdf:resour"e"="https://cim4.eu/ns/nc#RemedialActionScheduleStatusKind.proposed"/>
2625 <nc:RemedialActionSchedule.Contingency rdf:resource"#_5d587c7e-9ced-416a-ad17-6ef9b241a98"/>
2626 </nc:RemedialActionSchedule>
2627
2628

```

The Impact Assessment Matrix dataset is as follows:

```

2629 <nc:QualitativeRemedialActionImpact rdf:"D=" 70648bad-5435-49e8-82df-c0baa468e"d0">
2630 <cim:IdentifiedObject.mRID>70648bad-5435-49e8-82df-c0baa468e4d0</cim:IdentifiedObject.mRID>
2631 <nc:RemedialActionImpact.impactQuantity>5.8</nc:RemedialActionImpact.impactQuantity>
2632 <nc:RemedialActionImpact.kind rdf:resour"e"="https://cim4.eu/ns/nc#ImpactAgreementKind.alw"ys"/>
2633 <nc:RemedialActionImpact.AssessingSystemOperator rdf:resour"e"="#_1682bb5a-0eca-4923-a898-f7b6c4aa8"2b"/>
2634 <nc:RemedialActionImpact.RemedialAction rdf:resour"e"="#_5898c268-9b32-4ab5-9cfc-64546135a"37"/>
2635 </nc:QualitativeRemedialActionImpact>
2636
2637
2638 <nc:OwnerRemedialActionAssessment rdf:"D=" 1069a38a-f92d-4463-86ac-9ad315ffe"38">
2639 <cim:IdentifiedObject.mRID>1069a38a-f92d-4463-86ac-9ad315ffe38</cim:IdentifiedObject.mRID>
2640 <nc:OwnerRemedialActionAssessment.ImpactedSystemOperator rdf:resour"e"="#_1682bb5a-0eca-4923-a898-f7b6c4aa8"2b"/>
2641 <nc:OwnerRemedialActionAssessment.RemedialActionImpact rdf:resour"e"="#_70648bad-5435-49e8-82df-c0baa468e"d0"/>
2642 </nc:OwnerRemedialActionAssessment>
2643
2644
2645 <nc:CalculationBasedImpactAssessmentMatrix rdf:"D=" eaf1905f-327a-47c7-869a-2af02b88e"90">
2646 <cim:IdentifiedObject.mRID>eaf1905f-327a-47c7-869a-2af02b88e090</cim:IdentifiedObject.mRID>
2647 <cim:IdentifiedObject.name>IAM1</cim:IdentifiedObject.name>
2648 <cim:IdentifiedObject.description>This is an example of Impact Assessment
2649 Matrix</cim:IdentifiedObject.description>
2650 </nc:CalculationBasedImpactAssessmentMatrix>
2651
2652 <nc>ListBasedImpactAssessmentMatrix rdf:"D=" 79d7c6dc-3bbc-4e5b-af0f-653790ff0"eb">
2653 <cim:IdentifiedObject.mRID>79d7c6dc-3bbc-4e5b-af0f-653790ff07eb</cim:IdentifiedObject.mRID>
2654 <cim:IdentifiedObject.name>IAM2</cim:IdentifiedObject.name>
2655 <cim:IdentifiedObject.description>This is an example of Impact Assessment
2656 Matrix</cim:IdentifiedObject.description>
2657 </nc>ListBasedImpactAssessmentMatrix>
2658
2659 <nc:RemedialActionOutcomeValue rdf:"D=" a0cf09dd-449e-4e80-ab31-92a92bbb9"0e">
2660 <cim:IdentifiedObject.mRID>a0cf09dd-449e-4e80-ab31-92a92bbb990e</cim:IdentifiedObject.mRID>
2661 <nc:OutcomeValue.ImpactAssessmentMatrix rdf:resour"e"="#_eaf1905f-327a-47c7-869a-2af02b88e"90"/>
2662 <nc:OutcomeValue.ImpactedSystemOperator rdf:resour"e"="#_1682bb5a-0eca-4923-a898-f7b6c4aa8"2b"/>
2663 <nc:OutcomeValue.outcome rdf:resour"e"="https://cim4.eu/ns/nc#OutcomeImpactAssessmentKind.t"ue"/>
2664 <nc:RemedialActionOutcomeValue.RemedialAction rdf:resour"e"="#_5898c268-9b32-4ab5-9cfc-64546135a"37"/>
2665 </nc:RemedialActionOutcomeValue>
2666
2667 <nc:RemedialActionScheduleOutcomeValue rdf:"D=" 8c504edb-1e45-407a-a190-496c144a2"f9">
2668 <cim:IdentifiedObject.mRID>8c504edb-1e45-407a-a190-496c144a2ef9</cim:IdentifiedObject.mRID>
2669 <nc:OutcomeValue.ImpactAssessmentMatrix rdf:resour"e"="#_79d7c6dc-3bbc-4e5b-af0f-653790ff0"eb"/>
2670 <nc:OutcomeValue.ImpactedSystemOperator rdf:resour"e"="#_1682bb5a-0eca-4923-a898-f7b6c4aa8"2b"/>
2671 <nc:OutcomeValue.outcome rdf:resour"e"="https://cim4.eu/ns/nc#OutcomeImpactAssessmentKind.fa"se"/>
2672 <nc:RemedialActionOutcomeValue.RemedialActionSchedule rdf:resour"e"="#_264f9a19-ae29-4c95-b44c-6b7919ca0"6c"/>
2673 </nc:RemedialActionScheduleOutcomeValue>
2674

```

2675 The following snippets illustrate the Security Analysis Result dataset and the corresponding  
2676 Contingency, Equipment, and State Variables relationships.

2677 The Security Analysis Result dataset snippet is as follows:

```

2678 <nc:ContingencyPowerFlowResult rdf:"D=" ealee0-7e5e-46c1-8cf6-af110484a"f3">
2679 <cim:IdentifiedObject.mRID>ealee0-7e5e-46c1-8cf6-af110484adf3</cim:IdentifiedObject.mRID>
2680 <nc:ContingencyPowerFlowResult.Contingency rdf:resour"e"="#_7e31c67d-67ba-4592-8ac1-9e806d697"8e"/>
2681 <nc:PowerFlowResult.isViolation>true</nc:ContingencyPowerFlowResult.isViolation>
2682 <nc:PowerFlowResult.valueA>1673.4026</nc:ContingencyPowerFlowResult.valueA>
2683 <nc:PowerFlowResult.ACDCTerminal rdf:resour"e"="#_3b3075b8-e0e5-66e9-447e-d7e11f767"8f"/>
2684 <nc:PowerFlowResult.atTime>2023-03-28T07:30:00Z</nc:ContingencyPowerFlowResult.atTime>
2685 <nc:PowerFlowResult.ReportedByRegion rdf:resour"e"="#_09cfl44-3328-4127-861a-14f187aca"ff"/>
2686 <nc:PowerFlowResult.OperationalLimit rdf:resour"e"="#_b8fa5795-2fb2-3a9f-af51-44051d9fa"e7"/>
2687 </nc:ContingencyPowerFlowResult>
2688
2689 <nc:BaseCasePowerFlowResult rdf:"D=" b1d6ec9a-76d3-4162-b19a-99b09fcd8"fa">
2690 <cim:IdentifiedObject.mRID>b1d6ec9a-76d3-4162-b19a-99b09fcd80fa</cim:IdentifiedObject.mRID>
2691 <nc:PowerFlowResult.isViolation>false</nc:BaseCasePowerFlowResult.isViolation>
2692 <nc:PowerFlowResult.ACDCTerminal rdf:resour"e"="#_3b3075b8-e0e5-66e9-447e-d7e11f767"8f"/>
2693 <nc:PowerFlowResult.atTime>2023-03-28T06:30:00Z</nc:BaseCasePowerFlowResult.atTime>
2694 <nc:PowerFlowResult.valueW>-1.53093</nc:BaseCasePowerFlowResult.valueW>
2695 <nc:PowerFlowResult.valueVAR>0.961664</nc:BaseCasePowerFlowResult.valueVAR>
2696 <nc:PowerFlowResult.ReportedByRegion rdf:resour"e"="#_09cfl44-3328-4127-861a-14f187aca"ff"/>
2697 </nc:BaseCasePowerFlowResult>

```

2698 The corresponding Contingency dataset snippet is as follows:

```

2699 <nc:OrdinaryContingency rdf:"D=" 7e31c67d-67ba-4592-8ac1-9e806d697"8e">
2700 <cim:IdentifiedObject.name>CO2</cim:IdentifiedObject.name>
2701 <cim:IdentifiedObject.description>This is an example of an ordinary contingency;Tie Line
2702 loss</cim:IdentifiedObject.description>
2703 <cim:IdentifiedObject.mRID>7e31c67d-67ba-4592-8ac1-9e806d697c8e</cim:IdentifiedObject.mRID>
2704 <nc:Contingency.EquipmentOperator rdf:resour"e="https://data.europa.eu/energy/EIC/10X1001A1001A"94"/>
2705 <nc:Contingency.normalMustStudy>true</nc:Contingency.normalMustStudy>
2706 </nc:OrdinaryContingency>
2707
2708 <cim:ContingencyEquipment rdf:"D=" 7ec56068-a714-4445-ae19-dd34429ec"22">
2709 <cim:IdentifiedObject.name>L2</cim:IdentifiedObject.name>
2710 <cim:IdentifiedObject.description>The equipment for this contingency; Tie Line
2711 loss</cim:IdentifiedObject.description>
2712 <cim:IdentifiedObject.mRID>7ec56068-a714-4445-ae19-dd34429ec722</cim:IdentifiedObject.mRID>
2713 <cim:ContingencyElement.Contingency rdf:resour"e"#_7e31c67d-67ba-4592-8ac1-9e806d697"8e"/>
2714 <cim:ContingencyEquipment.contingentStatus
2715 rdf:resour"e="https://cim.ucauiog.io/nsContingencyEquipmentStatusKind.outOfServ"ce"/>
2716 <cim:ContingencyEquipment.Equipment rdf:resour"e"#_d9622e7f-5bf0-4e7e-b766-b8596c6fe"ae"/>
2717 </cim:ContingencyEquipment>

```

2718 The corresponding Equipment dataset snippet is as follows:

```

2719 <cim:ACLineSegment rdf:"D=" d9622e7f-5bf0-4e7e-b766-b8596c6fe"ae">
2720 <cim:ACLineSegment.b0ch>0.000147655</cim:ACLineSegment.b0ch>
2721 <cim:ACLineSegment.bch>9.42478e-5</cim:ACLineSegment.bch>
2722 <cim:ACLineSegment.g0ch>0.00015</cim:ACLineSegment.g0ch>
2723 <cim:ACLineSegment.gch>0.00015</cim:ACLineSegment.gch>
2724 <cim:ACLineSegment.r>4.3</cim:ACLineSegment.r>
2725 <cim:ACLineSegment.r0>7.1</cim:ACLineSegment.r0>
2726 <cim:ACLineSegment.shortCircuitEndTemperature>160</cim:ACLineSegment.shortCircuitEndTemperature>
2727 <cim:ACLineSegment.x>76</cim:ACLineSegment.x>
2728 <cim:ACLineSegment.x0>228</cim:ACLineSegment.x0>
2729 <cim:ConductingEquipment.BaseVoltage rdf:resour"e"#_63893f24-5b4e-407c-9a1e-4ff71121f"3c" />
2730 <cim:Conductor.length>100</cim:Conductor.length>
2731 <cim:Equipment.EquipmentContainer rdf:resour"e"#_77ca5612-67a1-4a52-a180-86560777a"4a" />
2732 <cim:IdentifiedObject.mRID>d9622e7f-5bf0-4e7e-b766-b8596c6fe4ae</cim:IdentifiedObject.mRID>
2733 <cim:IdentifiedObject.name>TieLine_BE_FR3</cim:IdentifiedObject.name>
2734 </cim:ACLineSegment>
2735 <cim:Terminal rdf:"D=" 3b3075b8-e0e5-66e9-447e-d7e11f767"8f">
2736 <cim:ACDCTerminal.sequenceNumber>2</cim:ACDCTerminal.sequenceNumber>
2737 <cim:IdentifiedObject.mRID>3b3075b8-e0e5-66e9-447e-d7e11f76788f</cim:IdentifiedObject.mRID>
2738 <cim:IdentifiedObject.name>Cub_2</cim:IdentifiedObject.name>
2739 <cim:Terminal.ConductingEquipment rdf:resour"e"#_d9622e7f-5bf0-4e7e-b766-b8596c6fe"ae" />
2740 <cim:Terminal.ConnectivityNode rdf:resour"e"#_f738d362-c11c-4ca2-82da-a4fa115b3"92" />
2741 <cim:Terminal.phases rdf:resour"e="https://cim.ucauiog.io/ns#PhaseCode."BC" />
2742 </cim:Terminal>
2743 <cim:OperationalLimitSet rdf:"D=" 60f26e2f-c17e-e662-8205-e09a7a451"44">
2744 <cim:IdentifiedObject.mRID>60f26e2f-c17e-e662-8205-e09a7a451844</cim:IdentifiedObject.mRID>
2745 <cim:IdentifiedObject.name>Current rating for TieLine_BE_FR3</cim:IdentifiedObject.name>
2746 <cim:OperationalLimitSet.Terminal rdf:resour"e"#_3b3075b8-e0e5-66e9-447e-d7e11f767"8f" />
2747 </cim:OperationalLimitSet>
2748 <cim:CurrentLimit rdf:"D=" b8fa5795-2fb2-3a9f-af51-44051d9fa"e7">
2749 <cim:CurrentLimit.normalValue>1574</cim:CurrentLimit.normalValue>
2750 <cim:IdentifiedObject.mRID>b8fa5795-2fb2-3a9f-af51-44051d9fa7</cim:IdentifiedObject.mRID>
2751 <cim:IdentifiedObject.name>pat1 for TieLine_BE_FR3</cim:IdentifiedObject.name>
2752 <cim:OperationalLimit.OperationalLimitSet rdf:resour"e"#_60f26e2f-c17e-e662-8205-e09a7a451"44" />
2753 <cim:OperationalLimit.OperationalLimitType rdf:resour"e"#_811ce332-2072-7ec8-8f15-1860770be"87" />
2754 </cim:CurrentLimit>

```

2755 The corresponding Steady State Hypothesis dataset snippet is as follows:

```

2756 <cim:CurrentLimit rdf:abo"t"# b8fa5795-2fb2-3a9f-af51-44051d9fa"e7">
2757 <cim:CurrentLimit.value>1574</cim:CurrentLimit.value>
2758 <cim:IdentifiedObject.mRID>b8fa5795-2fb2-3a9f-af51-44051d9fa7</cim:IdentifiedObject.mRID>
2759 </cim:CurrentLimit>

```

2760 The corresponding base case State Variables dataset snippet is as follows:

```

2761 <cim:SvPowerFlow rdf:"D=" 7807dd58-6c58-43d2-9998-83b6cc816"33">
2762 <cim:SvPowerFlow.Terminal rdf:resour"e"#_3b3075b8-e0e5-66e9-447e-d7e11f767"8f" />
2763 <cim:SvPowerFlow.p>-1.53093</cim:SvPowerFlow.p>
2764 <cim:SvPowerFlow.q>0.961664</cim:SvPowerFlow.q>
2765 </cim:SvPowerFlow>
2766

```

### 2767 7.5.3 Conformity Requirements

2768 To be able to support final validation the Application shall conform to the following Application  
2769 functions:

- 2770 • Coordination Confirmation.

## 2771 8 Application profile specification

### 2772 8.1 General

2773 Network codes related business process rely on data exchange standards to exchange the  
2774 information on power system models as well as the relevant additional information specific for  
2775 business processes. The set of information used by a business process is complex and has  
2776 many interdependencies. In addition, the complexity is amplified by the requirement that this  
2777 set of information needs to be used by multiple business processes as long as the timeframe  
2778 (day ahead, two days ahead, etc.) and timestamp (e.g. particular hour in a day ahead  
2779 timeframe) are the same. The requirements on this are set forth in the Network Codes related  
2780 EU Regulations and Guidelines.

2781 The following clarifications are important in order to have a common understanding on the types  
2782 of data that is being exchanged and what data exchange standards or specifications are used  
2783 to exchange it.

2784 • IGM (Individual Grid Model) is a term defined in CACM<sup>7</sup>. Other network codes and  
2785 methodologies refer to it. Additional requirements are specified by other network codes  
2786 and business process methodologies.

2787 • The IGM is the building block to create a common grid model (CGM) which is used to  
2788 perform business processes for a particular timestamp of a timeframe. It is prepared by  
2789 the modelling authority responsible for the power system.

2790 • CGM (Common Grid Model) is a term defined in CACM. Other network codes and  
2791 methodologies refer to it. A CGM includes all IGMs.

2792 • IGMs and a CGM represent the power system, its connectivity and essential  
2793 characteristics for the purpose of conducting power flow calculations (as a minimum  
2794 requirement). This comes with all details related to the power system model, e.g. what  
2795 portions of the grid are present, which data relates to the alternated current (AC) part  
2796 of the power system or direct current (DC) part of the power system, etc. The IGMs and  
2797 CGMs data exchange is covered by some of the profiles defined by the IEC CGMES  
2798 which is a standard that defines various profiles used in the data exchange.

2799 • The creation of IGMs, their collection and merging in CGMs is performed in the CGM  
2800 Build process.

2801 • The term “All relevant data” is used to describe all information that is exchanged in  
2802 addition to the CGMs and serves needs of different business processes, i.e., CCC, CSA,  
2803 OPC and Regional STA. This information includes structural, scheduled and per market  
2804 time unit data related to modelling of remedial actions, contingencies, assessed network  
2805 elements, availability plans (outage planning information), etc. The content of this data  
2806 is a superset of the requirements by all business processes that rely on CGMs of a  
2807 particular timestamp of a timeframe. This information exchange is covered by ENTSO-  
2808 E Network Codes profiles. Additional data such as data to support short circuit  
2809 calculations, geographical location information, diagram layout related information,  
2810 dynamics data can also be added, if necessary. The IEC CGMES or other standards  
2811 (e.g. IEC 61970-457 for dynamics and simulation settings) can be used to exchange this  
2812 information.

2813 • It is expected that all data delivered as IGM, CGM and All relevant data are consistent  
2814 and conform to both the specifications defined in the data standards and business  
2815 constraints that can be defined at pan-European or regional level. Data providers need  
2816 to ensure this as CGM Build process cannot guarantee the consistency due to the fact  
2817 that not all data is available in the CGM Build process.

<sup>7</sup> Commission Regulation (EU) 2015/1222 of 24 July 2015 establishing a guideline on capacity allocation and congestion management.

2818 • Consistency validation between "All relevant data" and a CGM is performed as part of  
2819 the business process that will use all data and can only result in invalidating "All relevant  
2820 data" (i.e., it cannot invalidate a CGM) which may lead to limiting the scope of the  
2821 business process. It is not expected that the CGM Build process is restarted to remedy  
2822 such inconsistencies. IGM and CGM improvements can be performed during the CGM  
2823 Build process.

2824 The CSA needs information on remedial actions, assessed elements, contingencies, etc in order  
2825 to complete the data needed to perform the coordinated security analysis. The all relevant data  
2826 for CSA is supplied by the following profiles:

- 2827 • Assessed element profile
- 2828 • Availability schedule profile
- 2829 • Contingency profile
- 2830 • Equipment reliability profile which includes SIPS configuration, security limits, Power  
2831 Transfer Corridor
- 2832 • Grid disturbance profile
- 2833 • Impact assessment matrix profile
- 2834 • Monitoring area profile
- 2835 • Object registry profile
- 2836 • Power schedule profile
- 2837 • Power system project profile
- 2838 • Remedial action profile
- 2839 • Remedial action schedule profile
- 2840 • Security analysis result profile
- 2841 • Sensitivity matrix profile
- 2842 • State instruction schedule profile
- 2843 • Steady state hypothesis schedule profile
- 2844 • Steady state instruction profile

## 2845 **8.2 Dataset Dependency**

2846 The dataset dependency is illustrated in Figure 46. The diagram contains most used datasets  
2847 conforming to different profiles but not necessarily all profiles. Therefore, for additional  
2848 dependencies between datasets based on CGMES profiles not shown in the diagram, the  
2849 dependencies provided in the CGMES are followed.

2850 Note that the RAS profile dataset is exchanged as a schedule and not per time unit.



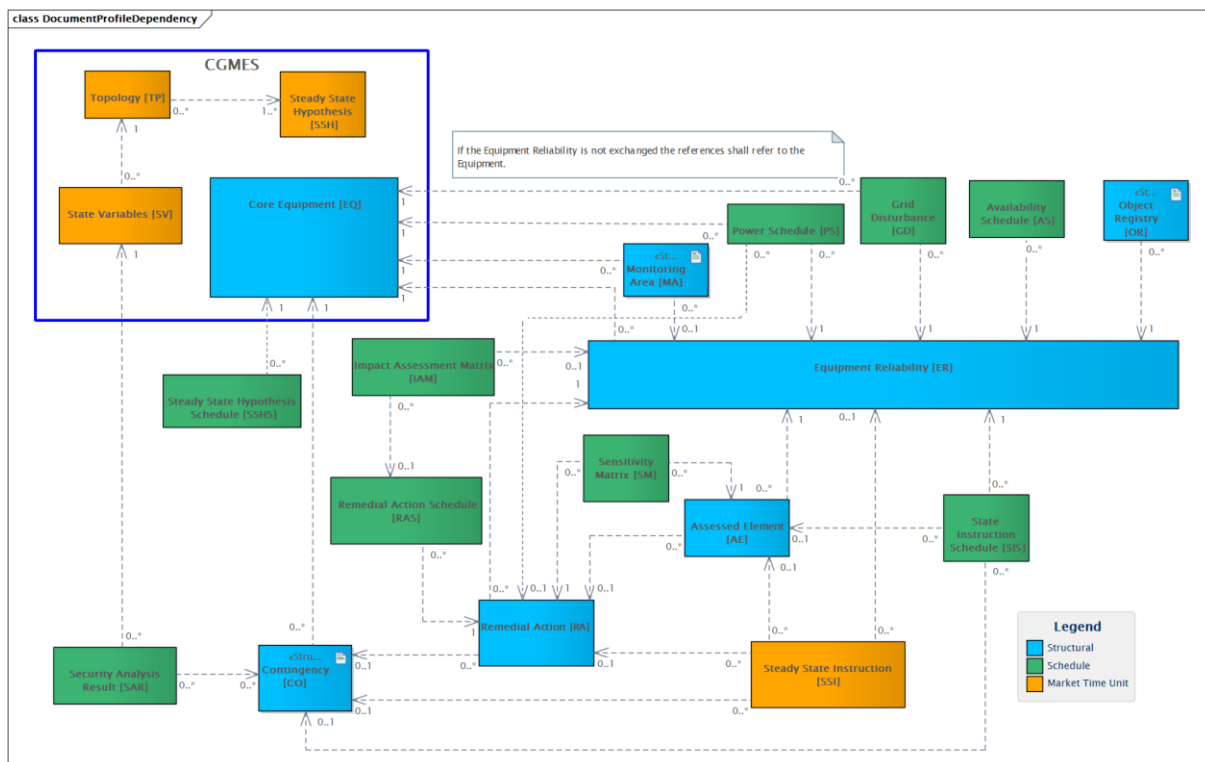

2851

2852

Figure 46 – Dataset dependencies

2853 **8.2.1 Dataset Metadata (Header)**

2854 Information on dependencies between datasets is provided by the attribute dcterms:references  
 2855 in the dataset metadata. This attribute is part of the ENTSO-E "Metadata for dataset and  
 2856 distribution specification". The header vocabulary contains all attributes defined in IEC 61970-  
 2857 552 and extended attributes to facilitate transition process for data exchanges that are using  
 2858 IEC 61970-552:2016 header. The updated header definitions rely on W3C recommendations  
 2859 which are used worldwide and are positively recognised by the European Commission.

2860 RCP DES does not use IEC 61970-552:2016 header attributes and relies only on the extended  
 2861 attributes in the ENTSO-E document. SHACL based constraints provided by ENTSO-E as  
 2862 application profiles define required cardinalities for attributes part of the dataset header.

2863 **8.3 Compatibility with Other Data Exchange Standards**

2864 NC profiles have been designed and developed as extension to the version of CIM used by  
 2865 CGMES v3.0 (IEC 61970-600-1 and -2:2021). In general, they partially are compatible with  
 2866 CGMES v2.4 (IEC TS 61970-600-1 and -2:2017) to the extent present in both CGMES v3.0 and  
 2867 v2.4. This means, there are model incompatibilities (due to bug fixes in v3.0 and clear  
 2868 documentation of intent), namespace incompatibilities (due CIM17 vs. CIM16 change), as well  
 2869 as serious limitations in scope if underlying model remains on CGMES v2.4. Therefore, the  
 2870 following attention points shall be noted:

2871 • If CGMES v2.4 is used to represent the IGM and CGM the remedial action cannot  
 2872 efficiently model power electronics and battery units as these objects are only available  
 2873 in CGMES v3.0. This also includes modelling limitation of representing control functions  
 2874 that have direct impact on the power flow calculation.

2875 • The information about the operational limits is exchanged in the equipment instance  
 2876 data in the case of CGMES v2.4 based data exchange. Therefore, when there is a need  
 2877 to frequently update the information on the limits, this will require that equipment data

2878 is exchanged more frequently or that difference equipment profile shall be used to  
2879 optimize the data exchange. This limitation does not occur if the IGM and CGM are  
2880 using CGMES v3.0 as the operational limits is exchanged in the steady state hypothesis  
2881 dataset.

2882 • In order to achieve an optimal information exchange, it is assumed that persistent  
2883 identifiers are used for the IGM and CGM objects. Applying datasets based on NC  
2884 profiles as add-on to an exchange which does not rely on persistent identifiers is neither  
2885 feasible nor practical for any downstream process relying on CGM.

2886 • Handling of topology remedial actions, power transfer corridors and their limits, SPS,  
2887 require more detailed underlying model. As CGMES v2.4 has clarity gaps in the modelling  
2888 of hybrid node breaker and bus branch models work arounds are not straight forward.  
2889 In addition, SOGL and CSAm detail the requirement of using node-breaker model and  
2890 defining topology as the data concerning the connectivity of the different transmission  
2891 system or distribution system elements in a substation and includes the electrical  
2892 configuration and the position of circuit breakers and isolators.

2893 The usage of UCTE DEF as a data exchange format for IGM and CGM for the purpose of CSA,  
2894 CCC, OPC, STA processes is not recommended in conjunction with NC set of profiles, for the  
2895 following non-exhaustive list of reasons (to name a few):

2896 • NC profiles metadata require linkage with the IGM and CGM. UCTE DEF models are  
2897 identified by file name. Therefore, an additional metadata layer must be added.

2898 • NC profiles require references to identifiers of the elements from IGM in order to link  
2899 the remedial actions, assessed elements, etc. UCTE DEF used node codes and circuit  
2900 numbers (for interconnecting elements) in order to uniquely identify them. Therefore, if  
2901 UCTE DEF is used there will be a need to maintain a list of persistent identifiers and  
2902 their relationship with node names or elements names.

2903 • CSA requires information on different operational limits that are related to the different  
2904 time phases to be studied. UCTE DEF has very limited capabilities to exchange limits.

2905 • Due to the scope of the UCTE DEF the business processes would be limited in terms of  
2906 what kind of grid state alterations and remedial actions could be described and  
2907 considered in the coordination process. Identification of type and modelling of the  
2908 network elements that support voltage control, shunt-connected reactive devices,  
2909 voltage regulation on transformers in case of regulator being modelled on the non-  
2910 regulated power transformer end, will require special attention as they are not in scope  
2911 of UCTE DEF and will be impossible to model without extending UCTE DEF.

2912 • Generation capacity used as part of remedial actions should be modelled in detail due  
2913 to limits handling in case of aggregated modelling.

2914 • UCTE DEF does not separate the information related to the equipment, the information  
2915 related to the operating point and it also does not cover the solution information. Data  
2916 consistency changes between data exchanged with NC profiles and UCTE DEF data  
2917 will be more extensive (full model exchange), have high dependencies over mapping  
2918 tables that have to be integrated in the middleware, and will not benefit from using one  
2919 equipment model for multiple time stamps.

2920 • UCTE DEF does not allow exchange of power flow solution data, therefore this report  
2921 will have to be standardized (out of scope of this document) to achieve full information  
2922 exchange.

- 2923 • Use of replaced IGM in created CGM is not possible to trace in case of UCTE DEF, that  
2924 might complicate the process of data consistency against the grid models and remedial  
2925 action applicability.

2926 Therefore, it is highly recommended that business processes plan for a transition to always rely  
2927 on latest data exchange standards and specifications in order to benefit from the consistency  
2928 at profile level (data exchange definition level) and be able to achieve business objectives  
2929 without being constraint by the data exchange.

#### 2930 **8.4 Common and Reference Data**

2931 In the context of RCP DES metadata is the following categories of data:

- 2932 • Common data: a set of data that is common for datasets from different publishers. It is  
2933 stable data that is kept mainly among TSOs community.
- 2934 • Reference data: a set of data that is part of taxonomy. It includes necessary minimum  
2935 and it is stable data that is reachable via URL. It can be defined by ENTSO-E or other  
2936 bodies and everybody, even outside TSO community can use it.
- 2937 • Dataset header: metadata that is exchanged as part of the dataset distribution to provide  
2938 necessary minimum of information.

2939 Both common data and reference data have stable identifiers and are maintained following strict  
2940 process. The key point with reference data and common data is that they are managed in  
2941 processes that are outside the process that are in focus, i.e. they are shared across several  
2942 business processes and among different parties, they are external to any one specific business  
2943 process, and well defined coordination is required.

2944 Applications implementing NC related data exchanges shall support the metadata and manage  
2945 the linkage with datasets conforming to CGMES and NC profiles.

##### 2946 **8.4.1 Common Data**

2947 Common data is normally maintained outside specific business process as it is valid for multiple  
2948 business processes. In general, there could be a portion of common data that is common for all  
2949 publishers within a business process, but this should be rather an exception. For instance, in  
2950 data exchanges using NC profiles, the following common data is foreseen:

- 2951 • Synchronous Area
- 2952 • Organisation and role - Transmission System Operator, Security Coordinator
- 2953 • Capacity Calculation Region
- 2954 • Bidding Zone Border
- 2955 • Bidding Zone
- 2956 • Overlapping Zone
- 2957 • Base voltage (currently exchanged as boundary set, but this is being separated in the  
2958 new setup)
- 2959 • Any other data agreed to be treated as common data.

2960 Therefore, the IGM creation process (delivering an IGM) and the process to prepare “All  
2961 relevant data” are dependent on each other so that consistency between different datasets is  
2962 ensured when datasets are prepared. Publishers (in this case TSOs) will refer to the identifiers  
2963 defined in the datasets of the common data and IGM. Other parties in the process such as RCC

2964 (RAO or other systems) will also use and refer to the common data when prepare the outputs  
2965 of a business process.

2966 In general, CGMES based data exchanges will also rely on common data such as information  
2967 on base voltages and other common elements that are currently added to boundary datasets.  
2968 It should be noted that boundary dataset can be seen as a kind of common data. However, this  
2969 dataset has a special function essential for connecting (merging) data from different publishers  
2970 (TSOs, modelling authorities – in general).

2971 Common data is serialised according to either CGMES or NC profiles. For example, Equipment  
2972 profile is used for the common data related to base voltages and Equipment Reliability profile  
2973 is used for capacity calculation regions data and other specified classes in this profile.  
2974 Therefore, datasets based on CGMES or NC profiles will refer to common data datasets via the  
2975 attribute dcterms:references in the dataset header.

#### 2976 8.4.2 Reference Data

2977 In order to have a better understanding of the metadata model, please review ENTSO-E  
2978 “Metadata for dataset and distribution specification” and ENTSO-E Boundary and reference  
2979 data exchange application specification which are available in [CGMES library](#) under the  
2980 ENTSO-E website.

2981 In general, reference data can include code list, taxonomies or resources that are maintained  
2982 in other processes.

2983 • **Code list:** A Code list is a structured and predefined set of codes or identifiers that  
2984 represent specific values, concepts, or categories within a defined domain. Some Code  
2985 lists are linked to the information model and are then represented as enumerators. Other  
2986 code list represent process and domain specific values. An example of a simple Code  
2987 list is the [Confidentiality](#) provided in Energy Reference Data SKOS Concept Schemes.

2988 • **Taxonomy:** Taxonomy is a systematic classification or arrangement of items, concepts,  
2989 or terms into hierarchical categories based on shared characteristics, attributes, or  
2990 relationships. It provides a structured framework for organizing information in a way that  
2991 facilitates understanding, retrieval, and communication. Taxonomies are used in various  
2992 fields, including biology, information science, knowledge management, and content  
2993 organization, to create a logical and standardized structure for categorizing and  
2994 organizing diverse elements. An example of a taxonomy is [FaultCauseType](#) provided in  
2995 Energy Reference Data SKOS Concept Schemes.

2996 • **Linked to resource:** An example of a linked to resource type of reference data is  
2997 [PowerFlowSettings](#) provided in Energy Reference Data SKOS Concept Schemes.

2998 The reference data is built using W3C recommendations, mainly, Provenance ontology (PROV-  
2999 O), Time Ontology and Data Catalog Vocabulary (DCAT), Simple Knowledge Organization  
3000 System (SKOS). The reference data can be referenced directly from the datasets. Examples of  
3001 reference data are:

3002 • Property Reference

3003 • Country ISO codes

3004 • Profiles URIs/identifiers

3005 • Spatial information

3006 • Any other data agreed to be treated as reference data.

3007 As of this writing, reference data is manually created and maintained, and is provided to project  
3008 participants as-is, to allow for implementations to progress. In the meantime, the process, and  
3009 the governance for target publication of reference data is under development and will be  
3010 leveraging linked data technologies and be managed centrally.

3011 It should be noted that there is no intention that applications should implement string decoding  
3012 of the URI address. The requirement is that applications shall access the URL (either in Internet  
3013 or locally if a service is provided) and interpret the properties defined in the RDF based dataset  
3014 that are related to a reference data item. There is some logic applied for the URIs, but this is  
3015 more for the purpose of human orientation. The following examples illustrate the logic that is  
3016 going to be applied when preparing the reference data:

3017 • Property Reference

3018 ○ <https://energy.referencedata.eu/PropertyReference/TapChanger.step>

3019 EIC codes, which is used in the `dcterms:publisher` in the dataset header

3020 ○ <https://energy.referencedata.eu/EIC/10T1001C--000170>

3021 • Spatial information (Frame, MAS) – in case of multiple modelling authority sets there  
3022 is a number, if only one MAS the number is not provided.

3023 ○ For DK west: <https://energy.referencedata.eu/DK-1-Power-Transmission-System>  
3024

3025 ○ For NO: <https://energy.referencedata.eu/NO-Power-Transmission-System>

3026 ○ For HVDC: <https://energy.referencedata.eu/NL-NO-Direct-Current-System>

3027 ○ For HVDC: <https://energy.referencedata.eu/FR-UK-1-Direct-Current-System>

3028 • Action (multiple business processes can reuse this action, it is used in  
3029 `prov:wasGeneratedBy` in the dataset header.)

3030 ○ [https://energy.referencedata.eu/{PROCESS}-{TIMEFRAME}-{RUN}-  
3031 {PROFILE\\_KEYWORD}](https://energy.referencedata.eu/{PROCESS}-{TIMEFRAME}-{RUN}-{PROFILE_KEYWORD})

3032 ○ <https://energy.referencedata.eu/CGM-1D-1-RAS>

3033 In general, this is a URI that can be used as URL to look up the detail attributes  
3034 describing the action. However, the URI pattern is descriptive to support human  
3035 readability. It is not intended to extract the meta information from the URI, `{PROCESS}-  
3036 {TIMEFRAME}-{RUN}`, only metadata information should be used for this purpose. Not  
3037 all items `{PROCESS}-{TIMEFRAME}-{RUN}` are relevant for all datasets. Particular  
3038 structure data like EQ will not necessarily include `{TIMEFRAME}-{RUN}`. CGM or  
3039 TYNDP (Ten Years Network Development Planning) might be used for dataset that can  
3040 be used in multiple processes. If the data is only used by a single process e.g. CSA then  
3041 CGM is replaced by CSA: <https://energy.referencedata.eu/CSA-1D-1>.

3042 • Abstract reference to the dataset that can have different versions is provided by  
3043 `dcat:isVersionOf`

3044 ○ <https://energy.referencedata.eu/Tenet-EQ> – for the equipment of TenneT

3045 ○ <https://energy.referencedata.eu/NorNed-EQ> – for the equipment of NorNed  
3046 HVDC

3047 **8.5 Dataset Distribution**3048 **8.5.1 Manifest**

3049 ENTSO-E “Metadata for dataset and distribution specification” defines how manifest can be  
3050 structured and exchanged. The document also includes examples of manifest. Business  
3051 processes can optimise the data exchange by using this approach. This approach provides  
3052 linkage between different datasets and information on the content which is important to know  
3053 prior importing all the datasets and processing their headers.

3054 **8.5.2 File Naming**

3055 Specifications of NC profiles do not specify file naming convention as it is required that all  
3056 relevant metadata is provided via the dataset header and separate manifest dataset which  
3057 conforms to the ENTSO-E “Metadata for dataset and distribution specification”. In cases naming  
3058 convention is necessary for human readability the ENTSO-E “Metadata for dataset and  
3059 distribution specification” recommend one which is in line with manifest specification.

3060 **8.5.3 Serialisation Syntax**

3061 Different serialisation syntaxes are used when providing the datasets conforming to reference  
3062 data, common data, constraints, CGMES profiles, and NC profiles. These serialisations will  
3063 evolve over time following best practices and new specifications by W3C and IEC. The following  
3064 list is provided for information.

3065 **Table 13 – Serialisation options**

Dataset category	Current serialisation	Expected future serialisation
Common data: mainly based on EQ and ER profiles	CIM XML (IEC 61970-552)	JSON-LD
Reference data	RDFXML (W3C), TURTLE (W3C), JSON-LD (W3C)	RDFXML (W3C), TURTLE (W3C), JSON-LD (W3C)
CGMES	CIMXML (IEC 61970-552)	JSON-LD
NC Profiles	CIMXML (IEC 61970-552)	JSON-LD
Manifest	JSON-LD, CIMXML (IEC 61970-552)	JSON-LD
Boundary set	CIMXML (IEC 61970-552)	JSON-LD
SHACL based constraints	TURTLE (W3C) mainly to facilitate human readability. Other RDF serialisations are possible.	TURTLE (W3C) mainly to facilitate human readability. Other RDF serialisations are possible.

3066

3067 **8.5.4 Exchange and Packaging**

3068 CIM based data exchanges allow for exchanging information based on multiple profiles in a  
3069 single dataset. Example for this is the exchange of equipment, operation and short circuit  
3070 profiles’ datasets in a single file. When this happens the dataset header shall include the  
3071 property dcterms:conformsTo to indicate to which profiles and constraints this data conforms  
3072 to. In an exchange which is structured and follows certain exchange rules, combining different  
3073 profiles cannot happen randomly and needs to be agreed so that receiving systems are  
3074 prepared to receive such information and process it accordingly.

3075 NC profiles can be used for exchange of data related to one CCR or multiple CCR. For example,  
3076 Assessed element profile includes references to regions at object level, which allows for  
3077 combining a list of assessed elements for all CCRs in a single dataset. The setup of the data  
3078 exchange does not require exchange of single dataset, but it is recommended to use all means  
3079 to avoid exchange of duplicate data. Business processes need to agree on what stages of the  
3080 process data is handled in separate datasets and at which step of the process a combined

3081 dataset is necessary. This should take into account that manifest dataset can be used to  
3082 exchange (report) on a combined set of data without the need to regroup the data within a single  
3083 dataset (file). Therefore, it is recommended to utilise the manifest way of exchange in order to  
3084 minimise the post processing of the data and bring essential clarity on the source if the data  
3085 including possibilities to exchange the provenance of it.

3086 Datasets serialised in CIMXML tend to have big file size and archive (zip) was traditionally used  
3087 in CGMES based datasets. Similar to CGMES archive-in-archive is not allowed. ENTSO-E  
3088 “Metadata for dataset and distribution specification” recommends using .cimx extension of the  
3089 archived files which are in reality zip archives. It is important that applications support this  
3090 extension and ensure that reading archives is done via stream or other service that does not  
3091 require full unzipping of the data, saving it and then parsing the information. The recommended  
3092 approach is to access the archive read the manifest, then assess parts of the archive in the  
3093 necessary sequence and then parsing the information without prior unzipping and storage. This  
3094 specification does not limit the usage of .cimx, i.e. this extension can be used when archiving  
3095 single datasets as well. However if .cimx is used the manifest file is required, if .zip is used the  
3096 content of the .zip shall follow the .zip rules.

### 3097 **8.6 Dataset Validation**

3098 Dataset validation is important part of the business process related data exchanges. In general,  
3099 datasets shall conform to the profile specifications on which the datasets are based on. In  
3100 addition, there are sets of constraints / consistency rules that are defined for the business  
3101 processes. NC profiles are supplying data for multiple business processes and there are  
3102 requirements by methodologies to define consistency rules for different processes. The  
3103 document NC Data Quality Management Provisions will need to be developed as required by  
3104 CSAm. It will define the data validation framework and SHACL based constraints (both for  
3105 consistencies within a dataset and across datasets) that are business specific and apply to  
3106 either all regions or to a particular region. The objective is to minimise the number of constraints  
3107 that apply to a particular region.

## 3109 9 Dependencies Between Business Processes

3110 This section will be completed in next versions of RCP DES in which other business processes  
3111 such as OPC, CCC, cost-sharing, etc will be covered.

## 3112 10 Conformity Assessment Scheme Setup Guidelines

3113 Different applications can be designed to support different parts of the business processes and  
3114 therefore utilise some or all NC profiles. The conformity assessment categories defined in this  
3115 section should be used in the Conformity Assessment Scheme designed for the conformity  
3116 process related to NC profiles (NC CAS). The use cases defined in RCP DES are direct input  
3117 to the Test Use Cases (TUC) part of NC CAS. Along with TUC it is important to define different  
3118 datasets (models and related data) that are needed to perform the test use cases. These  
3119 datasets to be used in the conformity are called Test Configuration (TC).

3120 This section defines the Application Functions that are considered important to cover the use  
3121 cases outlined in the RCP DES. A set of Test configurations and their high level content is also  
3122 defined.

3123 The section was reviewed in the SV-IOP in July 2024 and revisions were made. With the  
3124 establishment of the set of documentation related to conformity assessment scheme on the NC  
3125 Profiles this section will be moved to that set of documents.

### 3126 10.1 Application Functions

3127 Table 14 – Application functions defines necessary Application Functions to be included in the  
3128 NC CAS.

3129

**Table 14 – Application functions**

Name	Description	Prerequisite	Required profiles
Export of single dataset	The Application supports NC profiles' datasets that are either exported individually or together as a package.	Handling of reference data and common data	Applied for all NC profiles supported by the Application
Import of single dataset	The Application supports NC profiles' datasets that are either imported individually or together as a package.	Handling of reference data and common data	Applied for all NC profiles supported by the Application
Maintenance	The Application supports NC profiles' datasets and can perform maintenance operations (e.g. update, replace) on the data.	Handling of reference data and common data Import and export	Applied for all NC profiles supported by the Application
Structural data setup	The Application supports profiles related to the structural data of a business process.	The Application shall support: - interactions of NC profiles and CGMES profiles defining the underlying power system model.	Equipment Reliability (ER), Monitoring Area (MA), Contingency (CO), Remedial Action (RA), Assessed Element (AE)



		- Export of single profile for the related profiles	
Scheduled data setup	The Application shall support profiles related to the scheduled and per time unit data exchange.	The Application shall support: - interactions of NC profiles and CGMES profiles defining the underlying power system model. - Export of single profile for the related profiles	State Instruction Schedule (SIS), Steady State Instruction (SSI),
Coordination Confirmation	The Application the interactions between parties sending data and parties receiving data.	The Application shall support: - interactions of NC profiles and CGMES profiles defining the underlying power system model. - Export of single profile for the related profiles - Import of single profile for the related profiles	Remedial Action Schedule (RAS), Security Analysis Results (SAR)
Security analysis	The Application supports security analysis using power system model and information on contingencies and assessed elements. The Application can export the result of the security analysis.	The Application shall support: - interactions of NC profiles and CGMES profiles defining the underlying power system model. - Structural data - Scheduled data - Export of single profile for the related profiles	Security Analysis Results (SAR)
Remedial action optimization	The Application supports optimization of the remedial actions and can export the result.	The Application shall support: - interactions of NC profiles and CGMES profiles defining the underlying power system model. - Export of single profile for the related profiles	Remedial Action Schedule (RAS), Impact assessment Matrix (IAM)

3130

3131

3132

3133

3134 In order to target the right testing of the applications, the conformity assessment scheme will  
 3135 distinguish between the types of applications that are tested. For instance, an application that  
 3136 is designed to support analytic functions using the profiles as input will only need to conform to  
 3137 the analytic functions which will also test the ability to import and export the information.  
 3138 Therefore, such application will not be required to test separate import/export test use cases.

## 3139 10.2 Test Configurations

### 3140 10.2.1 Requirements

3141 Test configurations are necessary to perform test use cases defined for conformity.

- 3142 • Test configurations (TC) shall not be big models to allow for easy orientation.
- 3143 • TC shall be designed on CGMES v3.0 IGMs and CGMs.
- 3144 • There should be at least 4 TSOs represented in the test configuration.
- 3145 • There should be at least 2 CCR (Capacity Coordinating Regions) in the test  
 3146 configurations.
- 3147 • Test configurations shall cover all time frames – day ahead, intraday, year ahead, etc.
- 3148 • All test configurations shall be consistent and have proper header information as well  
 3149 be aligned with reference data in order to allow testing in OPDE at later stage.
- 3150 • There shall be a set of reference data according to equipment reliability profiles as well  
 3151 as other reference data and boundary information which shall be commonly shared  
 3152 between all test configurations. Using different sets of reference data shall be avoided  
 3153 as this causes issues and increases maintenance effort. However, it shall be possible  
 3154 to demonstrate an update of reference and boundary information.
- 3155 • Test configurations shall demonstrate the exchange of the following NC related profiles  
 3156 as well as all combinations of dependencies between below mentioned profiles and  
 3157 CGMES profiles:
  - 3158 ○ Assessed element profile (AE)
  - 3159 ○ Availability schedule profile (AS)
  - 3160 ○ Contingency profile (CO)
  - 3161 ○ Equipment reliability profile (ER)
  - 3162 ○ Grid Disturbance profile (GD)
  - 3163 ○ Impact assessment matrix profile (IAM)
  - 3164 ○ Monitoring area (MA)
  - 3165 ○ Object registry profile (OR)
  - 3166 ○ Power schedule (PS)
  - 3167 ○ Power system project (PSP)
  - 3168 ○ Remedial action profile (RA)
  - 3169 ○ Remedial action schedule profile (RAS)
  - 3170 ○ Security analysis result profile (SAR)

## 3171 ○ Sensitivity matrix profile (SM)

- 3172 ○ State instruction schedule profile (SIS)
- 3173 ○ Steady state hypothesis schedule profile (SHS)
- 3174 ○ Steady state instruction profile (SSI)
- 3175 • Test configurations shall be developed as conform test configurations. Non-conform test  
3176 configurations shall be developed as a second phase once it is proven that conform TCs  
3177 and profiles reach a good level of stability.
- 3178 • Remedial actions shall cover at least the following types:
- 3179 ○ Simple Remedial Actions of different types – change of setpoint, redispatch
- 3180 ○ Remedial Action dependent on a specific Contingency
- 3181 ○ Remedial Action dependent on a specific Assessed Element
- 3182 ○ Voltage Angle Remedial Actions
- 3183 ○ Voltage Magnitude Remedial Actions
- 3184 ○ PST
- 3185 ○ PST in a group
- 3186 ○ Topology change
- 3187 • Assessed element shall include lines, transformers, PSTs, busbar coupler, special  
3188 monitoring for voltage angle and magnitude.
- 3189 • Contingencies shall include at least:
- 3190 ○ N-1
- 3191 ○ N-x
- 3192 ○ Busbar tripping (even if it might be considered N-1)
- 3193 • Equipment reliability shall contain variants on the limits (Current Limits, Voltage Angle  
3194 Limits, Voltage Magnitude Limits) and SIPS configuration.
- 3195 • GLSK shall cover at least:
- 3196 ○ Generation ramping up
- 3197 ○ Generation ramping down
- 3198 ○ Load "cut-off" example
- 3199 ○ Example of energy blocks on power plants with several hours of start-up time

3200 **10.2.2 Types**

3201 Table 15 lists some test configurations that are considered important. Additional TCs can be  
3202 added in the NC CAS.

3203

**Table 15 – Test configurations**

Test configuration	Description
FullModelNC	This TC contains at least one instance of all classes and their attributes and associations defined in the NC Profiles.

OptimizedCSA	<p>This TC is developed using available models SmallGrid, Svedala and MicroGrid. This allows for inclusion of four TSOs with different granularity. In case of four TSOs that following setup is realised:</p> <ul style="list-style-type: none"> <li>•The 4 TSOs (A, B, C and D) have the following 3 borders indicated by the adjacency of the border to the TSOs (A-B, B-C, D-A).</li> <li>•The CCR1 covers the borders AB and BC, while CCR2 covers the border DA.</li> <li>•TSOs A, B and C participate to CCR1, whose impact extends to TSO D.</li> <li>•TSOs A and D participate to CCR2 whose impact extends to TSO B.</li> <li>•TSO A participates in both CCRs, TSO B in CCR1 but not CCR2 (although it is impacted by CCR2), TSO C participates in CCR 1 and it is not impacted by CCR2, and finally TSO D participates to CCR2 but not CCR1 (although it is impacted by CCR1). The resulting overlapping zone thus spans TSOs A, B and D.</li> </ul> <p>The test configuration includes minimum 24 and maximum 72 (or 96) hours/time stamps. The following profiles are included in addition to the IGM and CGM instance data: Equipment reliability profile (ER), Remedial action profile (RA), Remedial action schedule profile (RAS), Assessed element profile (AE), Contingency profile (CO), Availability schedule profile (AS), Steady state instruction profile (SSI), State instruction schedule profile (SIS), Impact assessment matrix profile (IAM), Sensitivity matrix profile (SM), Security analysis result profile (SAR), Object registry profile (OR)</p>
PerformanceNC	This TC is used to test performance of applications. The focus is on the volume of data and not on the complexity of the data.

### 3204 10.3 Test Use Cases

3205 This section defines basic test use cases that are considered important to initiate the Conformity  
3206 Assessment Scheme related to NC profiles. Additional test use cases can be added during the  
3207 development of NC CAS and its maintenance.

#### 3208 10.3.1 TUC 1: Exchange of Initial Information

- 3209 • TSO A, TSO B, TSO C, TSO D export the following information (in real cases some  
3210 of these could be optional, but for the purpose of the test full scope is considered):
  - 3211 ○ IGM
  - 3212 ○ remedial actions
  - 3213 ○ assessed elements
  - 3214 ○ contingency
  - 3215 ○ equipment reliability which includes SIPS configuration, security limits and  
3216 power transfer corridor definitions

3217 ○ steady state instruction

3218 ○ GLSK

3219 ○ Availability schedule

3220 ○ Object registry

3221 • RCC A and RCC B import all information. Consistency checks are performed.

3222 • CGMs are merged and available.

3223 **10.3.2 TUC 2: Perform Regional Security Analysis and Export Results**

3224 • RCC A and RCC B perform regional security analysis on a CGM

3225 • RCC A and RCC B export security analysis results

3226 **10.3.3 TUC 3: Perform RAO and Export Results, perform Coordination and Export**  
3227 **results**

3228 This includes the workflow of the coordination runs

3229 • RCC A and RCC B perform RAO

3230 • RCC A and RCC B export security analysis results after RAO and proposed remedial  
3231 actions schedules (using remedial action schedule profile)3232 • RCC A and RCC B perform impact assessment on proposed remedial actions and  
3233 exports impact assessment matrix3234 • TSO A, TSO B, TSO C and TSO D send agreed and rejected remedial actions or  
3235 eventually propose alternatives (coordination): Alternatives could be available RAs  
3236 to be considered for the next iteration of RAO, or RA schedules to be further  
3237 assessed. Please note that currently the RCCs and the CCRs have not yet agreed  
3238 on a common process and rules for the evaluation and inclusion of alternative RA  
3239 schedules.3240 • RCC A and RCC B perform security analysis after Coordination. RCC A and RCC B  
3241 export security analysis results and updated impact assessment matrix.

3242 • TSO A, TSO B, TSO C and TSO D update IGMs (SSH, TP, SV) if needed.

3243

3244 **11 Annex A: Document Revision History**

Version <sup>8</sup>	Date	Paragraph	Comments
1.0.0	2021-04-21		SOC approved.
2.0.0	2022-02-16		The specification was enriched with the following extensions and related profiles: <ul style="list-style-type: none"> <li>Equipment Reliability (Including energy areas and roles related to network codes, Direct Current related to DC Poles for Corridors). The content of this profile will be integrated as optional extension to the EQ profile of CGMES (similar to e.g. Equipment ShortCircuit).</li> <li>Steady State Instruction</li> </ul>

<sup>8</sup> Versioning of the document follows [Semantic Versioning 2.0.0](#) where a version number is having four components {major}.{minor}.{patch}-{pre-release}.

			<ul style="list-style-type: none"> <li>System Integrity Protection Schemes (SIPS) as part of the Remedial Action profile</li> <li>Power Transfer Corridors (PTC) as part of Equipment Reliability profile.</li> <li>Availability plan</li> <li>Generation and Load Shift Keys (Time phase, contingency induced balance, variation of losses)</li> <li>Security limits as part of Equipment Reliability</li> </ul> <p>SOC approved.</p>
2.1.0	2022-09-21		<p>The specification considers the following changes:</p> <ul style="list-style-type: none"> <li>Availability plan was renamed to Availability Schedule</li> <li>A new profile for sensitivity matrix was included</li> <li>Small changes to solve bugs and improve consistency of the profiles.</li> <li>Comments received during v2.0 were considered.</li> </ul> <p>SOC approved.</p>
2.2.0	2023-04-20		<p>This new version of the specification is mainly focused on covering gaps identified by CCRs. Most important changes are related to:</p> <ul style="list-style-type: none"> <li>Redispatch and countertrade</li> <li>Schedules</li> <li>Sensitivity factors</li> <li>Updates of the control model for power electronics devices and transformers.</li> <li>Several clarifications were introduced to facilitate the usage of the profiles.</li> </ul>
2.2.0	2023-05-10		<p>Reference metadata table updated to be consistent with a bug fix from the maintenance request "Change in Metadata and document header data exchange specification" from May 2023 the 8<sup>th</sup>.</p> <p>ICTC approved.</p>
2.3.0-alpha	2024-01-29		<p>On request by SOC StG REC the document was renamed to Network Codes Data Exchange Specification to envision that it will cover specifications and implementation guidance for all business processes. The document is significantly updated to include explanations on different used cases.</p>
2.3.0-beta	2024-03-16		<p>On request by SOC the document was renamed to Regional Coordination Processes Data Exchange Specification to envision that it will cover specifications and implementation guidance for all business processes. The document is updated based on the feedback from review of version v2.3.0-alpha.</p>
2.3.0-gamma	2024-04-09		<p>Version after the CIM WG review and send for the approval process via written voting procedure by ICTC (lead) and SOC (in copy).</p>
2.3.0	2024-05-13		<p>ICTC (lead) + SOC (in copy) approved.</p>
2.3.1	2024-10-16		<p>ICTC approved.</p> <p>Patch changes (bug fixing, corrections and fixing imperfections) after the feedback received in the 2024 SV-IOP.</p>
2.3.2	2025-02-13		<p>ICTC approved.</p>

			Only modifies the Table 1 to correctly refer to the version numbering of the Network Code profiles patch release 2.3.2.
--	--	--	---

3245

3246

3247